

FANUC SERVO AMPLIFIER *β*i series

I/O Link Option

MAINTENANCE MANUAL

- No part of this manual may be reproduced in any form.
- All specifications and designs are subject to change without notice.

In this manual we have tried as much as possible to describe all the various matters.

However, we cannot describe all the matters which must not be done, or which cannot be done, because there are so many possibilities.

Therefore, matters which are not especially described as possible in this manual should be regarded as "impossible".

SAFETY PRECAUTIONS

The "Safety Precautions" section describes the safety precautions relating to the use of FANUC servo motors and servo amplifiers (βi SVM). Users of any servo motor or amplifier model are requested to read the "Safety Precautions" carefully before using the motor or amplifier.

The users are also requested to read an applicable specification manual carefully and understand each function of the motor or amplifier for correct use.

The users are basically forbidden to do any behavior or action not mentioned in the "Safety Precautions." They are invited to ask FANUC previously about what behavior or action is prohibited.

Contents

1.1	DEFINITION OF WARNING, CAUTION, AND NOTE	s-2
1.2	FANUC AC SERVO MOTOR βi s series	s-3
1.2.1	Warning	s-3
1.2.2	Caution	s-6
1.2.3	Note	s-7
1.3	FANUC SERVO AMPLIFIER βi series	s-9
1.3.1	Warnings and Cautions Relating to Mounting	s-9
1.3.1.1	Warning	s-9
1.3.1.2	Caution	s-11
1.3.1.3	Note	s-13
1.3.2	Warnings and Cautions Relating to a Pilot Run	s-14
1.3.2.1	Warning	s-14
1.3.2.2	Caution	s-15
1.3.3	Warnings and Cautions Relating to Maintenance	s-16
1.3.3.1	Warning	s-16
1.3.4.2	Caution	s-18
1.3.4.3	Note	s-19

1.1 DEFINITION OF WARNING, CAUTION, AND NOTE

This manual includes safety precautions for protecting the user and preventing damage to the machine. Precautions are classified into Warning and Caution according to their bearing on safety. Also, supplementary information is described as a Note. Read the Warning, Caution, and Note thoroughly before attempting to use the machine.

 **WARNING**

Applied when there is a danger of the user being injured or when there is a damage of both the user being injured and the equipment being damaged if the approved procedure is not observed.

 **CAUTION**

Applied when there is a danger of the equipment being damaged, if the approved procedure is not observed.

NOTE

The Note is used to indicate supplementary information other than Warning and Caution.

* Read this manual carefully, and store it in a safe place.

1.2 FANUC AC SERVO MOTOR β is series

1.2.1 Warning

WARNING

- **Be safely dressed when handling a motor.**
Wear safety shoes or gloves when handling a motor as you may get hurt on any edge or protrusion on it or electric shocks.
- **Use a crane or lift to move a motor from one place to another.**
A motor is heavy. If you lift the motor by hand, you may get a backache, or you may be seriously injured when you drop the motor. A suitable crane or lift must be used to move the motor. (For the weight of motors, refer to their respective Descriptions.)
When moving a motor using a crane or lift, use a hanging bolt if the motor has a corresponding tapped hole, or textile rope if it has no tapped hole.
If a motor is attached with a machine or any other heavy stuff, do not use a hanging bolt to move the motor as the hanging bolt and/or motor may get broken.
- **Before starting to connect a motor to electric wires, make sure they are isolated from an electric power source.**
A failure to observe this caution is very dangerous because you may get electric shocks.
- **Be sure to secure power wires.**
If operation is performed with a terminal loose, the terminal block may become abnormally hot, possibly causing a fire. Also, the terminal may become disconnected, causing a ground fault or short-circuit, and possibly giving you electric shocks. See the section in this manual that gives the tightening torque for attaching power wires and short-bars to the terminal block.
- **Be sure to ground a motor frame.**
To avoid electric shocks, be sure to connect the grounding terminal in the terminal box to the grounding terminal of the machine.
- **Do not ground a motor power wire terminal or short-circuit it to another power wire terminal.**
A failure to observe this caution may cause electric shocks or a burned wiring.
(*) Some motors require a special connection such as a winding changeover. Refer to their respective motor Descriptions for details.

 **WARNING**

- **Do not supply the power to the motor while any terminal is exposed.**
A failure to observe this caution is very dangerous because you may get electric shocks if your body or any conductive stuff touches an exposed terminal.
- **Do not bring any dangerous stuff near a motor.**
Motors are connected to a power line, and may get hot. If a flammable is placed near a motor, it may be ignited, catch fire, or explode.
- **Do not get close to a rotary section of a motor when it is rotating.**
You may get your clothes or fingers caught in a rotary section, and may be injured. Before starting a motor, ensure that there is no stuff that can fly away (such as a key) on the motor.
- **Do not touch a motor with a wet hand.**
A failure to observe this caution is vary dangerous because you may get electric shocks.
- **Before touching a motor, shut off the power to it.**
Even if a motor is not rotating, there may be a voltage across the terminals of the motor.
Especially before touching a power supply connection, take sufficient precautions.
Otherwise you may get electric shocks.
- **Do not touch any terminal of a motor for a while (at least 5 minutes) after the power to the motor is shut off.**
High voltage remains across power line terminals of a motor for a while after the power to the motor is shut off. So, do not touch any terminal or connect it to any other equipment. Otherwise, you may get electric shocks or the motor and/or equipment may get damaged.
- **To drive a motor, use a specified amplifier and parameters.**
Driving a motor with other than the specified combinations of an amplifier and parameters may cause the motor to perform an unexpected operation; for example, the motor may get out of control, or produce excessively high torque. This may result in the motor or machine being damaged. Also, an object such as a workpiece or tool may fly off due to excessive rotation, possibly causing injury.
- **Do not touch a regenerative discharge unit for a while (at least 30 minutes) after the power to the motor is shut off.**
A regenerative discharge unit may get hot when the motor is running.
Do not touch the regenerative discharge unit before it gets cool enough. Otherwise, you may get burned.

- **When designing and assembling a machine tool, make it compliant with EN60204-1.**
To ensure the safety of the machine tool and satisfy European standards, when designing and assembling a machine tool, make it compliant with EN60204-1. For details of the machine tool, refer to its specification manual.
- **Do not touch a motor when it is running or immediately after it stops.**
A motor may get hot when it is running. Do not touch the motor before it gets cool enough. Otherwise, you may get burned.
- **Be careful not get your hair or cloths caught in a fan.**
Be careful especially for a fan used to generate an inward air flow. Be careful also for a fan even when the motor is stopped, because it continues to rotate while the amplifier is turned on.
- **Ensure that motors and related components are mounted securely.**
If a motor or its component slips out of place or comes off when the motor is running, it is very dangerous.

1.2.2 Caution

CAUTION

- **FANUC motors are designed for use with machines. Do not use them for any other purpose.**
If a FANUC motor is used for an unintended purpose, it may cause an unexpected symptom or trouble. If you want to use a motor for an unintended purpose, previously consult with FANUC.
- **Ensure that a base or frame on which a motor is mounted is strong enough.**
Motors are heavy. If a base or frame on which a motor is mounted is not strong enough, it is impossible to achieve the required precision.
- **Be sure to connect motor cables correctly.**
An incorrect connection of a cable cause abnormal heat generation, equipment malfunction, or failure. Always use a cable with an appropriate current carrying capacity (or thickness). For how to connect cables to motors, refer to their respective Descriptions.
- **Ensure that motors are cooled if they are those that require forcible cooling.**
If a motor that requires forcible cooling is not cooled normally, it may cause a failure or trouble. For a fan-cooled motor, ensure that it is not clogged or blocked with dust and dirt. For a liquid-cooled motor, ensure that the amount of the liquid is appropriate and that the liquid piping is not clogged.
For both types, perform regular cleaning and inspection.
- **When attaching a component having inertia, such as a pulley, to a motor, ensure that any imbalance between the motor and component is minimized.**
If there is a large imbalance, the motor may vibrates abnormally, resulting in the motor being broken.
- **Be sure to attach a key to a motor with a keyed shaft.**
If a motor with a keyed shaft runs with no key attached, it may impair torque transmission or cause imbalance, resulting in the motor being broken.

1.2.3 Note

NOTE

- **Do not step or sit on a motor.**
If you step or sit on a motor, it may get deformed or broken. Do not put a motor on another unless they are in packages.
- **When storing a motor, put it in a dry (non-condensing) place at room temperature (0 to 40°C).**
If a motor is stored in a humid or hot place, its components may get damaged or deteriorated. In addition, keep a motor in such a position that its shaft is held horizontal and its terminal box is at the top.
- **Do not remove a nameplate from a motor.**
If a nameplate comes off, be careful not to lose it. If the nameplate is lost, the motor becomes unidentifiable, resulting in maintenance becoming impossible.
For a nameplate for a built-in spindle motor, keep the nameplate with the spindle.
- **Do not apply shocks to a motor or cause scratches to it.**
If a motor is subjected to shocks or is scratched, its components may be adversely affected, resulting in normal operation being impaired. Be very careful when handling plastic portions, sensors, and windings, because they are very liable to break. Especially, avoid lifting a motor by pulling its plastic portion, winding, or power cable.
- **Do not conduct dielectric strength or insulation test for a sensor.**
Such a test can damage elements in the sensor.
- **When testing the winding or insulation resistance of a motor, satisfy the conditions stipulated in IEC60034.**
Testing a motor under a condition severer than those specified in IEC60034 may damage the motor.
- **Do not disassemble a motor.**
Disassembling a motor may cause a failure or trouble in it.
If disassembly is in need because of maintenance or repair, please contact a service representative of FANUC.
- **Do not modify a motor.**
Do not modify a motor unless directed by FANUC. Modifying a motor may cause a failure or trouble in it.

NOTE

- **Use a motor under an appropriate environmental condition.**
Using a motor in an adverse environment may cause a failure or trouble in it.
Refer to their respective Descriptions for details of the operating and environmental conditions for motors.
- **Do not apply a commercial power source voltage directly to a motor.**
Applying a commercial power source voltage directly to a motor may result in its windings being burned. Be sure to use a specified amplifier for supplying voltage to the motor.
- **For a motor with a terminal box, make a conduit hole for the terminal box in a specified position.**
When making a conduit hole, be careful not to break or damage unspecified portions.
Refer to an applicable Descriptions.
- **Before using a motor, measure its winding and insulation resistances, and make sure they are normal.**
Especially for a motor that has been stored for a prolonged period of time, conduct these checks. A motor may deteriorate depending on the condition under which it is stored or the time during which it is stored. For the winding resistances of motors, refer to their respective Descriptions, or ask FANUC. For insulation resistances, see the following table.
- **To use a motor as long as possible, perform periodic maintenance and inspection for it, and check its winding and insulation resistances.**
Note that extremely severe inspections (such as dielectric strength tests) of a motor may damage its windings. For the winding resistances of motors, refer to their respective Descriptions, or ask FANUC. For insulation resistances, see the following table.

MOTOR INSULATION RESISTANCE MEASUREMENT

Measure an insulation resistance between each winding and motor frame using an insulation resistance meter (500 VDC).
Judge the measurements according to the following table.

Insulation resistance	Judgment
100MΩ or higher	Acceptable
10 to 100 MΩ	The winding has begun deteriorating. There is no problem with the performance at present. Be sure to perform periodic inspection.
1 to 10 MΩ	The winding has considerably deteriorated. Special care is in need. Be sure to perform periodic inspection.
Lower than 1 MΩ	Unacceptable. Replace the motor.

1.3 FANUC SERVO AMPLIFIER β i series

1.3.1 Warnings and Cautions Relating to Mounting

1.3.1.1 Warning

WARNING

- **Check the specification code of the amplifier.**
Check that the delivered amplifier is as originally ordered.
- **Mount a ground fault interrupter.**
To guard against fire and electric shock, fit the factory power supply or machine with a ground fault interrupter (designed for use with an inverter).
- **Securely ground the amplifier.**
Securely connect the ground terminal and metal frame of the amplifier and motor to a common ground plate of the power magnetics cabinet.
- **Be aware of the weight of the amplifier and other components.**
Some amplifiers, AC reactors and AC line filters are heavy. When transporting them or mounting them in the cabinet, therefore, be careful not to injure yourself or damage the equipment. Be particularly careful not to jam your fingers between the cabinet and amplifier.
- **Never ground or short-circuit either the power supply lines or power lines.**
Protect the lines from any stress such as bending. Handle the ends appropriately.
- **Ensure that the power supply lines, power lines, and signal lines are securely connected.**
A loose screw, loose connection, or the like will cause a motor malfunction or overheating, or a ground fault.
Be extremely careful with power supply lines, motor power lines, and DC link connections through which a large amount of current passes, because a loose screw (or poor contact in a connector or poor connection between a connector terminal and a cable) may cause a fire.
- **Insulate all exposed parts that are charged.**
- **Never touch the regenerative discharge resistor or radiator directly.**
The surface of the radiator and regenerative discharge unit become extremely hot. Never touch them directly. An appropriate structure should also be considered.

 WARNING

- **Close the amplifier cover after completing the wiring.**
Leaving the cover open presents a danger of electric shock.
- **Do not disassemble the amplifier.**
- **Ensure that the cables used for the power supply lines and power lines are of the appropriate diameter and temperature ratings.**
- **Do not apply an excessively large force to plastic parts.**
If a plastic section breaks, it may cause internal damage, thus interfering with normal operation. The edge of a broken section is likely to be sharp and, therefore, presents a risk of injury.

1.3.1.2 Caution

CAUTION

- **Do not step or sit on the amplifier.**
Also, do not stack unpacked amplifiers on top of each other.
- **Use the amplifier in an appropriate environment.**
See the allowable ambient temperatures and other requirements, given in the corresponding Descriptions.
- **Protect the amplifier from corrosive or conductive mist or drops of water.**
Use a filter if necessary.
- **Protect the amplifier from impact.**
Do not place anything on the amplifier.
- **Do not block the air inlet to the radiator.**
A deposit of coolant, oil mist, or chips on the air inlet will result in a reduction in the cooling efficiency. In some cases, the required efficiency cannot be achieved. The deposit may also lead to a reduction in the useful life of the semiconductors. Especially, when outside air is drawn in, mount filters on both the air inlet and outlet. These filters must be replaced regularly.
So, an easy-to-replace type of filter should be used.
- **Connect the power supply lines and power lines to the appropriate terminals and connectors.**
- **Connect the signal lines to the appropriate connectors.**
- **Before connecting the power supply wiring, check the supply voltage.**
Check that the supply voltage is within the range specified in the Descriptions, then connect the power supply lines.
- **Ensure that the combination of motor and amplifier is appropriate.**
- **Ensure that valid parameters are specified.**
Specifying an invalid parameter for the combination of motor and amplifier may not only prevent normal operation of the motor but also result in damage to the amplifier.
- **Ensure that the amplifier and peripheral equipment are securely connected.**
Check that the magnetic contactor, circuit breaker, and other devices mounted outside the amplifier are securely connected to each other and that those devices are securely connected to the amplifier.

 CAUTION

- **Check that the amplifier is securely mounted in the power magnetics cabinet.**
If any clearance is left between the power magnetics cabinet and the surface on which the amplifier is mounted, dust entering the gap may build up and prevent the normal operation of the amplifier.
- **Apply appropriate countermeasures against noise.**
Adequate countermeasures against noise are required to maintain normal operation of the amplifier. For example, signal lines must be routed away from power supply lines and power lines.
- **Attachment and detachment of connectors**
When power is on, avoid attaching and detaching connectors unless otherwise noted. Otherwise, the amplifier can become faulty.

1.3.1.3 Note

NOTE

- **Keep the nameplate clearly visible.**
- **Keep the legend on the nameplate clearly visible.**
- **After unpacking the amplifier, carefully check for any damage.**
- **Mount the amplifier in a location where it can be easily accessed periodic inspection and daily maintenance.**
- **Leave sufficient space around the machine to enable maintenance to be performed easily.**
Do not place any heavy objects such that they would interfere with the opening of the doors.
- **Keep the parameter table and spare parts at hand.**
Also, keep the Descriptions at hand. These items must be stored in a location where they can be retrieved immediately.
- **Provide adequate shielding.**
A cable to be shielded must be securely connected to the ground plate, using a cable clamp or the like.

1.3.2 Warnings and Cautions Relating to a Pilot Run

1.3.2.1 Warning

WARNING

- **Before turning on the power, check that the cables connected to the power magnetics cabinet and amplifier, as well as the power lines and power supply lines, are securely connected. Also, check that no lines are slack.**

A loose screw, loose connection, or the like will cause a motor malfunction or overheating, or a ground fault. Be extremely careful with power supply lines, motor power lines, and DC link connections through which a large amount of current passes, because a loose screw (or poor contact in a connector or poor connection between a connector terminal and a cable) may cause a fire.

- **Before turning on the power, ensure that the power magnetics cabinet is securely grounded.**

- **Before turning on the power, check that the door of the power magnetics cabinet and all other doors are closed.**

Ensure that the door of the power magnetics cabinet containing the amplifier, and all other doors, are securely closed. During operation, all doors must be closed and locked.

- **Apply extreme caution if the door of the power magnetics cabinet or another door must be opened.**

Only a person trained in the maintenance of the corresponding machine or equipment should open the door, and only after shutting off the power supply to the power magnetics cabinet (by opening both the input circuit breaker of the power magnetics cabinet and the factory switch used to supply power to the cabinet). If the machine must be operated with the door open to enable adjustment or for some other purpose, the operator must keep his or her hands and tools well away from any dangerous voltages. Such work must be done only by a person trained in the maintenance of the machine or equipment.

- **When operating the machine for the first time, check that the machine operates as instructed.**

To check whether the machine operates as instructed, first specify a small value for the motor, then increase the value gradually. If the motor operates abnormally, perform an emergency stop immediately.

- **After turning on the power, check the operation of the emergency stop circuit.**

Press the emergency stop button to check that the motor stops immediately, and that the power being supplied to the amplifier is shut off by the magnetic contactor.

 WARNING

- **Before opening a door or protective cover of a machine to enable adjustment of the machine, first place the machine in the emergency stop state and check that the motor has stopped.**

1.3.2.2 Caution

CAUTION

- **Note whether an alarm status relative to the amplifier is displayed at power-up or during operation.**
If an alarm is displayed, take appropriate action as explained in this manual. If the work to be done requires that the door of the power magnetics cabinet be left open, the work must be carried out by a person trained in the maintenance of the machine or equipment. Note that if some alarms are forcibly reset to enable operation to continue, the amplifier may be damaged. Take appropriate action according to the contents of the alarm.
- **Before operating the motor for the first time, mount and adjust the position and speed sensors.**
Following the instructions given in this manual, adjust the position and speed sensors for the spindle so that an appropriate waveform is obtained.
If the sensors are not properly adjusted, the motor may not rotate normally or the spindle may fail to stop as desired.
- **If the motor makes any abnormal noise or vibration while operating, stop it immediately.**
Note that if operation is continued in spite of there being some abnormal noise or vibration, the amplifier may be damaged. Take appropriate corrective action, then resume operation.
- **Observe the ambient temperature and output rating requirements.**
The continuous output rating or continuous operation period of some amplifiers may fall as the ambient temperature increases. If the amplifier is used continuously with an excessive load applied, the amplifier may be damaged.
- **Unless otherwise specified, do not insert or remove any connector while the power is turned on. Otherwise, the amplifier may fail.**

1.3.3 Warnings and Cautions Relating to Maintenance

1.3.3.1 Warning

WARNING

- **Read this manual carefully and ensure that you are totally familiar with its contents.**

This manual describes daily maintenance and the procedures to be followed in the event of an alarm being issued. The operator must be familiar with these descriptions.

- **Notes on replacing a fuse or PC board**
 - 1) Before starting the replacement work, ensure that the circuit breaker protecting the power magnetics cabinet is open.
 - 2) Check that the red LED that indicates that charging is in progress is not lit.

The position of the charging LED on each model of amplifier is given in the Descriptions. While the LED is lit, hazardous voltages are present inside the unit, and thus there is a danger of electric shock.
 - 3) Some PC board components become extremely hot. Be careful not to touch these components.
 - 4) Ensure that a fuse having an appropriate rating is used.
 - 5) Check the specification code of a PC board to be replaced. If a modification drawing number is indicated, contact FANUC before replacing the PC board.

Also, before and after replacing a PC board, check its pin settings.
 - 6) After replacing a fuse, make sure that the fuse is inserted into the socket all the way to the root.
 - 7) After replacing the PC board, ensure that it is securely connected.
 - 8) Ensure that all power lines, power supply lines, and connectors are securely connected.

- **Take care not to lose any screws.**

When removing the case or PC board, take care not to lose any screws. If a screw is lost inside the nit and the power is turned on, the machine may be damaged.

 WARNING

- **Notes on replacing the battery of the absolute Pulsecoder**
Replace the battery only while the power is on. If the battery is replaced while the power is turned off, the stored absolute positioning data will be lost. A battery may be mounted on the servo amplifier of the β i series servo amplifier module. In this case, before starting to replace the battery, you must open the power magnetics cabinet door and take the machine to an emergency stop to shut down the power to the amplifier without turning off the control power. Replacement work should be done only by a person who is trained in the related maintenance and safety requirements. The power magnetics cabinet in which the servo amplifier is mounted has a high-voltage section. This section presents a severe risk of electric shock.
- **Check the number of any alarm.**
If the machine stops upon an alarm being issued, check the alarm number. Some alarms indicate that a component must be replaced. If the power is reconnected without first replacing the failed component, another component may be damaged, making it difficult to locate the original cause of the alarm.
- **Before resetting an alarm, ensure that the original cause of the alarm has been removed.**
- **Contact FANUC whenever a question relating to maintenance arises.**
- **Notes on removing the amplifier**
Before removing the amplifier, first ensure that the power is shut off. Be careful not to jam your fingers between the power magnetics cabinet and amplifier.

1.3.3.2 Caution

CAUTION

- **Ensure that all required components are mounted.**
When replacing a component or PC board, check that all components, including the snubber capacitor, are correctly mounted. If the snubber capacitor is not mounted, for example, the IPM will be damaged.
- **Tighten all screws firmly.**
- **Check the specification code of the fuse, PC board, and other components.**
When replacing a fuse or PC board, first check the specification code of the fuse or PC board, then mount it in the correct position. The machine will not operate normally if a fuse or PC board having other than the correct specification code is mounted, or if a fuse or PC board is mounted in the wrong position.
- **Mount the correct cover.**
The cover on the front of the amplifier carries a label indicating a specification code. When mounting a previously removed front cover, take care to mount it on the unit from which it was removed.
- **Notes on cleaning the heat sink and fan**
 - 1) A dirty heat sink or fan results in reduced semiconductor cooling efficiency, which degrades reliability. Periodic cleaning is necessary.
 - 2) Using compressed air for cleaning scatters the dust. A deposit of conductive dust on the amplifier or peripheral equipment will result in a failure.
 - 3) To clean the heat sink, do so only after turning the power off and ensuring that the heat sink has cooled to room temperature. The heat sink becomes extremely hot, such that touching it during operation or immediately after power-off is likely to cause a burn. Be extremely careful when touching the heat sink.

1.3.3.3 Note

NOTE

- **Ensure that the battery connector is correctly inserted.**
If the power is shut off while the battery connector is not connected correctly, the absolute position data for the machine will be lost.
- **Store the manuals in a safe place.**
The manuals should be stored in a location where they can be accessed immediately if so required during maintenance work.
- **Notes on contacting FANUC**
Inform FANUC of the details of an alarm and the specification code of the amplifier so that any components required for maintenance can be quickly secured, and any other necessary action can be taken without delay.

PREFACE

Organization of this manual

This manual describes information necessary to maintain FANUC SERVO AMPLIFIER βi series products, such as a βi SVM and FANUC SERVO MOTOR βis series products.

Parts I, II, III and IV explain the start-up procedure, operation, troubleshooting, and maintenance for the βi series SVM.

Part V explains the maintenance for βis series servo motor.

The abbreviations listed below are used in this manual.

Product name	Abbreviations
FANUC Series 15 <i>i</i>	FS15 <i>i</i>
FANUC Series 16 <i>i</i>	FS16 <i>i</i>
FANUC Series 18 <i>i</i>	FS18 <i>i</i>
FANUC Series 21 <i>i</i>	FS21 <i>i</i>
FANUC Series 0 <i>i</i>	FS0 <i>i</i>
FANUC Series 30 <i>i</i>	FS30 <i>i</i>
FANUC Series 31 <i>i</i>	FS31 <i>i</i>
FANUC Series 32 <i>i</i>	FS32 <i>i</i>
FANUC Power Mate <i>i</i> -D	PM <i>i</i>
FANUC Power Mate <i>i</i> -H	
FANUC SERVO AMPLIFIER βi series SVM Power Supply Module	βi SVM, SVM, Servo Amplifier Module

* The manuals shown below provide information related to this manual. This manual may refer you to these manuals.

FANUC SERVO AMPLIFIER βi series Descriptions B-65322EN

FANUC AC SERVO MOTOR βis series Descriptions B-65302EN

FANUC AC SERVO MOTOR $\alpha is/\alpha i/\beta is$ series Parameter Manual
B-65270EN

WARNING

When maintaining and inspecting the servo amplifier module, keep the power turned off and make sure that the LED (red) on the front panel of the servo amplifier module that indicates whether electric charge is in progress is off. (See Appendix A.)

TABLE OF CONTENTS

SAFETY PRECAUTIONS	s-1
---------------------------------	------------

PREFACE	p-1
----------------------	------------

I. START-UP PROCEDURE

1 OVERVIEW	3
-------------------------	----------

2 CONFIGURATIONS	4
-------------------------------	----------

2.1 CONFIGURATIONS	5
--------------------------	---

2.2 MAJOR COMPONENTS	6
----------------------------	---

2.2.1 Servo Amplifier Modules	6
-------------------------------------	---

3 START-UP PROCEDURE	7
-----------------------------------	----------

3.1 START-UP PROCEDURE (OVERVIEW)	8
---	---

3.2 CONNECTING THE POWER	9
--------------------------------	---

3.2.1 Checking the Voltage and Capacity of the Power	9
--	---

3.2.2 Connecting a Protective Ground	9
--	---

3.2.3 Selecting the Ground Fault Interrupter That Matches the Leakage Current	9
---	---

3.3 INITIALIZING PARAMETERS (SWITCHES AND DUMMY CONNECTORS)	10
--	----

3.4 PARAMETER INITIALIZATION	11
------------------------------------	----

4 CONFIRMATION OF THE OPERATION	15
--	-----------

4.1 CHECK PROCEDURE	16
---------------------------	----

5 PERIODIC MAINTENANCE OF SERVO AMPLIFIER	19
--	-----------

5.1 BATTERY FOR THE ABSOLUTE PULSECODER	20
---	----

5.2 PERIODIC MAINTENANCE OF SERVO AMPLIFIER	28
---	----

II. HANDLING

1 OVERVIEW	33
-------------------------	-----------

1.1 SERVO AMPLIFIER MODULE INTERFACE	34
--	----

1.2 FANUC I/O LINK INTERFACE AREA	34
---	----

1.3 INTERFACE	35
---------------------	----

1.3.1 Peripheral Equipment Control Interface	35
--	----

1.3.2 Direct Command Interface	35
--------------------------------------	----

1.3.3 Interface Switching	35
---------------------------------	----

1.4 CAUTIONS ON USING THE POWER MATE CNC	36
--	----

2	SIGNAL DESCRIPTIONS	37
2.1	DO/DO SIGNALS	38
2.1.1	Peripheral Equipment Control Interface.....	38
2.1.2	Direct Command Interface	40
2.2	SIGNALS (LISTED IN GROUPS)	42
2.3	SIGNAL DETAILS.....	44
2.3.1	Preparation Completion.....	44
2.3.2	Reset and Emergency Stop.....	45
2.3.3	Alarm.....	46
2.3.4	Mode Selection.....	47
2.3.5	Jog Feed.....	47
2.3.6	Status Signals	48
2.3.7	Feedrate	52
2.3.8	Interlock	54
2.3.9	Reference Position Return.....	54
2.3.10	Automatic Operation	55
2.3.11	Clamp and Unclamp (for the Peripheral Equipment Control Interface Only).....	56
2.3.12	Servo-off.....	57
2.3.13	Peripheral Equipment Control Function Code and Related Information	58
2.3.14	Direct Command Function Code and Related Information	62
2.3.15	Direct Input Signals.....	68
3	PERIPHERAL EQUIPMENT CONTROL.....	71
3.1	COMMAND FORMAT FOR PERIPHERAL EQUIPMENT CONTROL.....	72
3.2	PERIPHERAL EQUIPMENT CONTROL PROCEDURE.....	73
3.2.1	Specifying Operation Using a Function Code.....	73
3.2.2	Receiving Response Data	73
3.3	FUNCTION CODES	74
3.3.1	Function Codes.....	74
3.4	DETAILS OF FUNCTION CODES.....	76
3.4.1	ATC/Turret Control.....	76
3.4.2	Point Positioning Control	78
3.4.3	Reference Position Return.....	80
3.4.4	Reference Position Setting (when the Reference Position External Setting Function is Used).....	82
3.4.5	Positioning Control (Absolute/Incremental Specification, for Skip Function)	84
3.4.6	Speed Control	86
3.4.6.1	Overview	86

	3.4.6.2	System configuration	86
	3.4.6.3	Peripheral equipment control command format.....	87
	3.4.6.4	Command timing chart	89
	3.4.6.5	Parameter	92
	3.4.6.6	Signal	94
	3.4.6.7	Alarm	94
	3.4.6.8	Others	95
	3.4.7	Coordinate System Setting	96
	3.4.8	Rewriting of Parameters	97
	3.4.8.1	Overview	97
	3.4.8.2	System configuration	97
	3.4.8.3	Peripheral equipment control command format.....	98
	3.4.8.4	Command timing chart	99
	3.4.8.5	Alarm	99
	3.4.8.6	Parameter	99
	3.4.9	Control of the Point Data External Setting Function.....	100
	3.4.10	Teaching-based Data Setting Control.....	101
3.5		REFERENCE POSITION RETURN FUNCTION WITH DOGS.....	102
	3.5.1	Explanation of Function	102
	3.5.1.1	Reference position return operation (grid method).....	102
	3.5.1.2	Deceleration limit switch installation condition	103
	3.5.1.3	Tip	104
	3.5.2	Parameter.....	105
3.6		UPGRADING OF THE ROTATION AXIS CONTROL FUNCTION	106
	3.6.1	Function for Specifying the Direction of Rotation Axis High-speed Reference Position Return	106
	3.6.1.1	Explanation of function	106
	3.6.1.2	Parameter	106
	3.6.2	Rotation Axis Rotation Direction Sign Specification Function	107
	3.6.2.1	Explanation of function	107
	3.6.2.2	Example of program	107
	3.6.2.3	Parameter	107
3.7		UPGRADING OF THE CLAMP/UNCLAMP CONTROL FUNCTION	108
	3.7.1	Start of the Timer Counting Until Servo-off in Clamp Processing	108
	3.7.1.1	Explanation of function	108
	3.7.1.2	Parameter	108
	3.7.2	Disabling of Clamp Processing When Jog Operation is Stopped	108
	3.7.2.1	Explanation of function	108
	3.7.2.2	Parameter	108
3.8		UPGRADING OF THE RESPONSE DATA READ FUNCTION	109
	3.8.1	Overview	109

3.8.2	Details of Function	109
3.8.3	DI/DO Signals	110
3.8.4	Parameter	111
3.8.5	Notes	112
3.9	IMPROVEMENT OF TURRET/MAGAZINE NUMBER OUTPUT	114
3.9.1	Overview	114
3.9.2	Details of Function	114
3.9.3	Signal	118
3.9.4	Parameter	120
3.9.4.1	Related parameters	121
3.10	MANUAL HANDLE INTERFACE	124
3.10.1	Overview	124
3.10.2	Details of Function	124
3.10.3	Signal	125
3.10.3.1	Signal on the servo amplifier module	125
3.10.3.2	Signal on the CNC (host)	126
3.10.4	Parameter	127
3.10.4.1	Parameter on the servo amplifier module	127
3.10.4.2	Parameter on the CNC (host)	127
4	DIRECT COMMANDS	128
4.1	DIRECT COMMAND FORMAT	129
4.2	DIRECT COMMAND CONTROL PROCEDURE	131
4.2.1	Direct Command Control Procedure	131
4.2.2	Instruction Command Control (EBUF, EBSY, and ECNT)	132
4.2.3	Response Command Control (EOREND, EOSTB, EOPC, USR1, and ECONT)	133
4.2.4	Command Completion Notification (ECF)	133
4.2.5	Alarm (DAL)	134
4.2.6	Direct Command Execution Result	134
4.3	LIST OF DIRECT COMMANDS	135
4.4	DETAILS OF DIRECT COMMAND FUNCTIONS	136
4.4.1	Signal Operation Commands	136
4.4.2	Parameter	137
4.4.3	Status Read	140
4.4.4	Axis Movement Commands	154
4.5	THIRTY-TWO-BLOCK BUFFERING OPERATION	167
4.5.1	Overview	167
4.5.2	Memory Registration Procedure	167

4.5.3	Operation Procedure.....	168
5	EXTERNAL PULSE INPUT FUNCTION	169
5.1	OVERVIEW	170
5.2	DETAILED DESCRIPTION.....	171
6	UNEXPECTED DISTURBANCE TORQUE DETECTION FUNCTION (OPTIONAL FUNCTION)	172
6.1	OVERVIEW	173
6.2	SERIES AND EDITIONS OF APPLICABLE SERVO SOFTWARE.....	174
6.3	SETUP METHOD	175
6.3.1	Overview	175
6.3.2	Details of the Setup Method.....	176
6.4	SIGNAL	180
6.5	PARAMETER	181
6.6	ALARM	183
6.7	DIAGNOSIS.....	183
7	QUICK STOP FUNCTION.....	184
7.1	OVERVIEW	185
7.2	SERIES AND EDITIONS OF APPLICABLE SERVO SOFTWARE.....	185
7.3	SETTING METHOD.....	185
7.4	PARAMETER	186
III. TROUBLESHOOTING		
1	OVERVIEW	189
2	ALARM NUMBERS AND BRIEF DESCRIPTIONS	190
3	ACTION AGAINST NOISE.....	201
3.1	NOTES ON CONNECTING THE GROUND SYSTEMS.....	203
3.2	NOTES ON SELECTING THE SPARK KILLER	206
IV. MAINTENANCE OF SERVO AMPLIFIER MODULES		
1	HOW TO REPLACE THE FUSES AND PRINTED CIRCUIT BOARDS	211
1.1	HOW TO REPLACE THE FUSES AND PRINTED CIRCUIT BOARDS.....	212
1.1.1	Ordering Number of Printed Circuit Board.....	214
1.1.2	Fuse Locations.....	214
1.2	HOW TO REPLACE THE FAN MOTOR.....	215

1.2.1 For Fan Motors for Internal Agitation for SVM1-4*i* and SVM1-20*i* 215
 1.2.2 For Fan Motors for Internal Agitation for SVM1-40*i* and SVM1-80*i* 216
 1.2.3 External-Fan Motor 217

V. SERVO MOTOR MAINTENANCE

1 SERVO MOTOR MAINTENANCE 221
 1.1 RECEIVING AND KEEPING AC SERVO MOTORS 222
 1.2 DAILY INSPECTION OF AC SERVO MOTORS 223
 1.3 PERIODIC INSPECTION OF AC SERVO MOTORS 225
 1.4 REPLACING THE PULSECODER 228
 1.5 SPECIFICATION NUMBERS OF REPLACEMENT PARTS..... 230

APPENDIX

A SERVO AMPLIFIER MODULE FRONT VIEW 233
B PARAMETER LIST 235
 B.1 CONTROLLED-AXIS PARAMETERS 242
 B.2 COORDINATE SYSTEM AND STROKE LIMIT PARAMETERS 243
 B.3 FEEDRATE PARAMETERS 247
 B.4 ACCELERATION/DECELERATION CONTROL PARAMETERS 250
 B.5 INPUT/OUTPUT SIGNALS PARAMETERS 253
 B.6 SERVO PARAMETERS 264
 B.7 DIGITAL SERVO STANDARD PARAMETER TABLE 286
C DIAGNOSIS LISTS 288
 C.1 SIGNALS SENT FROM CNC (HOST) TO SERVO AMPLIFIER
 MODULE 289
 C.1.1 Peripheral Equipment Control Interface (DRC = 0)..... 289
 C.1.2 Direct Command Interface (DRC = 1) 289
 C.2 SIGNALS SENT FROM SERVO AMPLIFIER MODULE TO CNC (HOST) 290
 C.2.1 Peripheral Equipment Control Interface (DRC = 0)..... 290
 C.2.2 Direct Command Interface (DRC = 1) 290
 C.3 SERVO POSITIONAL DEVIATION AMOUNT
 (SERVO AMPLIFIER MODULE)..... 291
 C.4 ACCELERATION/DECELERATION DELAY AMOUNT
 (SERVO AMPLIFIER MODULE)..... 291
 C.5 FUNCTION BIT (SERVO AMPLIFIER MODULE)..... 291
 C.6 DIRECT INPUT SIGNAL STATUSES (SERVO AMPLIFIER MODULE).... 291

D	POWER MATE CNC MANAGER FUNCTIONS	292
D.1	POWER MATE CNC MANAGER FUNCTIONS (Series 16, 18, 21, Power Mate)	293
D.1.1	Overview	293
D.1.2	I/O Link Connection.....	293
D.1.3	Function Selection and Termination	293
D.1.3.1	Selection	293
D.1.3.2	Function Selection Soft Key.....	294
D.1.3.3	Termination.....	294
D.1.3.4	Disabling the Power Mate CNC Manager Functions	294
D.1.3.5	Parameter Setting.....	295
D.1.3.6	Restriction.....	296
D.1.4	Function Overview	297
D.1.4.1	Soft key status transition diagram.....	297
D.1.4.2	Screen configuration.....	299
D.1.4.3	Operations of an Active Slave	301
D.1.5	FUNCTION DETAILS	302
D.1.5.1	System Configuration	302
D.1.5.2	Parameters.....	304
D.1.5.3	Diagnosis	306
D.1.5.4	Absolute Coordinate.....	307
D.1.5.5	Machine Coordinates	308
D.1.5.6	Alarms	308
D.1.6	Alarm Display on the Power Mate CNC Manager.....	309
D.2	POWER MATE CNC MANAGER FUNCTION (Series 30 <i>i</i> , 31 <i>i</i> , 32 <i>i</i>).....	310
D.2.1	Screen Display.....	311
D.2.2	Inputting and Outputting Parameters.....	317
D.2.3	Parameters	319
D.2.4	Warning.....	320
D.2.5	Note	321
E	SERVO CHECK BOARD	322

I. START-UP PROCEDURE

1

OVERVIEW

This part describes the units and components of the FANUC servo amplifier. It also explains the following information necessary to start up the servo amplifier:

- Configurations
- Start-up procedure
- Confirmation of the operation
- Periodic maintenance of servo amplifier

2 CONFIGURATIONS

2.1 CONFIGURATIONS

A system using FANUC servo amplifier β i series SVMs consists of the following units and parts:

- (1) Servo amplifier module (SVM) (basic)
- (2) AC line filter (basic)
- (3) Connectors (for connecting cables) (basic)
- (4) Fuses (option)
- (5) Power transformer (option)

Constituent (example)

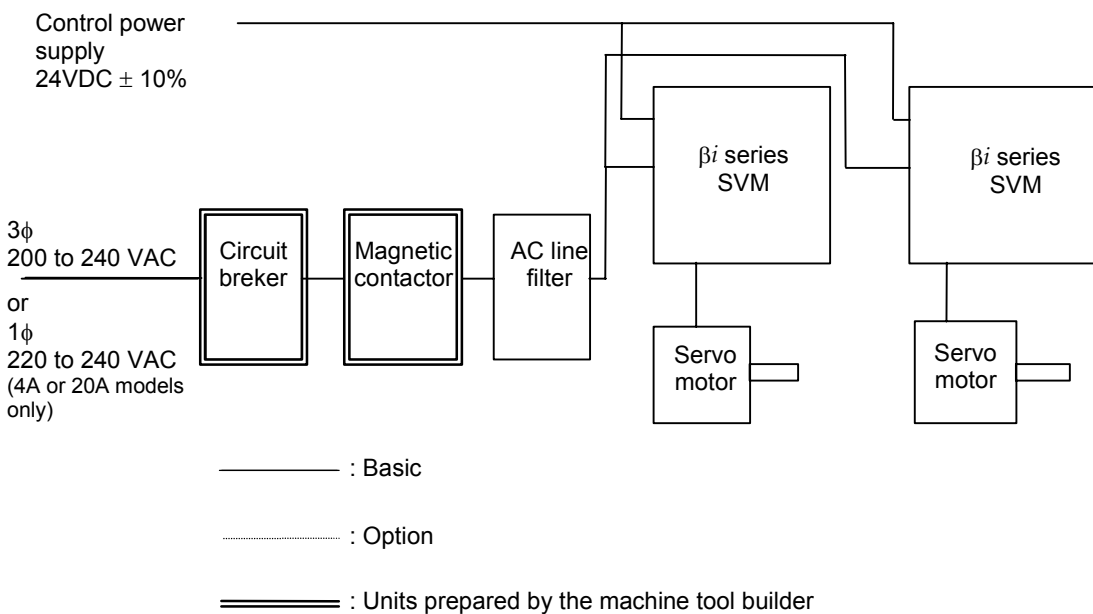

NOTE

- 1 A circuit breakers, magnetic contactor, and AC line filter are always required.
- 2 To protect the unit from surge currents caused by lightning, connect surge absorbers between lines, and between the lines and ground, at the power inlet of the power magnetics cabinet.
- 3 The AC line filter is different from the AC reactor, which is designed for another purpose. Substituting one for the other or using one as both the filter and reactor is not allowed.

2.2 MAJOR COMPONENTS

2.2.1 Servo Amplifier Modules

(1) Servo amplifier module (SVM1)

Model	Order specification	Unit specification	Wiring board specification	Printed circuit board specification
SVM1-4 <i>i</i>	A06B-6132-H001	A06B-6132-C001	A20B-2101-0090	A20B-8101-0200
SVM1-20 <i>i</i>	A06B-6132-H002	A06B-6132-C002	A20B-2101-0091	
SVM1-40 <i>i</i>	A06B-6132-H003	A06B-6132-C003	A16B-3200-0512	
SVM1-80 <i>i</i>	A06B-6132-H004	A06B-6132-C004	A16B-3200-0513	

3

START-UP PROCEDURE

3.1 START-UP PROCEDURE (OVERVIEW)

Make sure that the specifications of the CNC, servo motors, servo amplifiers, and other units you received are exactly what you ordered, and these units are connected correctly. Then, turn on the power.

(1) Before turning on the circuit breaker, check the power supply voltage connected.
Make sure that the protective ground is connected. Also make sure that the selected ground fault interrupter is appropriate for the leakage current that is anticipated.
→ See Section 3.2.



(2) Before the system can be used, some switches and dummy connectors require setting. So, check the necessary settings.
→ See Section 3.3.



(3) Start the servo amplifier module.



(4) Start the CNC.



(5) Set up parameters.

3.2 CONNECTING THE POWER

3.2.1 Checking the Voltage and Capacity of the Power

Before connecting the power, you should measure the AC power voltage.

Table 3.2.1(a) Action for the AC power (200-V input type)

Permissible voltage fluctuation width	Nominal voltage	Action
-15% +10%	3-phase 200 to 240VAC	SVM1-4i, SVM1-20i SVM1-40i, SVM1-80i Permitted. Note) If the voltage is below the rated value, the rated output may not be obtained.
-15% +10%	1-phase 220 to 240VAC	SVM1-4i, SVM1-20i Single-phase input is permitted when the power supply is 380 to 415 VAC to neutral grounding.
Other than the above		SVM1-4i, SVM1-20i SVM1-40i, SVM1-80i Not permitted. Use an insulating transformer to adjust the input voltage.

Table 3.2.1 (b) list the input power specification. Use a power source with sufficient capacity so that the system will not malfunction due to a voltage drop even at a time of peak load.

Table 3.2.1 (b) AC power voltage specifications (200-V input type)

Model	SVM1-4i	SVM1-20i	SVM1-40i	SVM1-80i
Nominal voltage rating	200 to 240VAC -15%, +10%			
Power source frequency	50/60Hz \pm 1Hz			
Power source capacity (for the main circuit) [kVA]	0.2	1.9	3.9	6.2
Power source capacity (for the control circuit) [kVA]	22			

3.2.2 Connecting a Protective Ground

Check that the protective ground line is connected correctly.

3.2.3 Selecting the Ground Fault Interrupter That Matches the Leakage Current

Check that a correct ground fault interrupter is selected.

3.3 INITIALIZING PARAMETERS (SWITCHES AND DUMMY CONNECTORS)

SVM1-4i, SVM1-20i

- When no regenerative resistor is used
Connect connector CXA20 by using a dummy connector.
See FANUC SERVO AMPLIFIER βi series DESCRIPTIONS (B-65322EN).

SVM1-40i, SVM1-80i

- Switch (SW) setting
The regenerative resistor alarm level is set. The setting condition varies depending on the regenerative resistor used (the built-in regenerative resistor or separate regenerative resistor). Perform the setting properly.

**WARNING**

Incorrect setting can damage the regenerative resistor.

See FANUC SERVO AMPLIFIER βi series DESCRIPTIONS (B-65322EN).

- When the built-in regenerative resistor is used
Connect connector CXA20 by using a dummy connector.
Connect connector CZ6 by using a dummy connector.
See FANUC SERVO AMPLIFIER βi series DESCRIPTIONS (B-65322EN).

3.4 PARAMETER INITIALIZATION

- (1) Preparation prior to servo parameter initialization
 Before servo parameter initialization, check the following:
 <1> Servo motor model (Example: $\beta 8/3000is$)
 <2> Amount of travel per motor rotation (Example: 10 mm/motor revolution)

At first, decide "detection unit", for example detection unit = 1 μ m.
 Next, calculate number of pulses per motor revolution with "detection unit" and "amount of travel per motor revolution".

$$\begin{aligned} & \text{(Number of pulses per motor revolution)} \\ & = \text{(Amount of travel per motor revolution)} / \text{(Detection unit)} \end{aligned}$$

Example)

In case detection unit = 1 μ m, amount of travel per motor revolution = 10mm
 10mm/1 μ m=10000
 Then, number of pulses per motor revolution = 10000 pulses/revolution

- (2) Procedure for servo parameter initialization
 <1> Turn on the power to the servo amplifier module.
 <2> Turn on the power to the host controller in the emergency stop state.
 <3> Perform parameter initialization from the CNC.
 Set values for the parameters listed below. (See <5> to <9>.)

	Example	Parameter number
Motor type number	258	No.125
CMR	2	No.32
Numerator for the number of pulses per revolution	10000	No.105
Denominator for the number of pulses per revolution	1	No.106
Direction of travel	111	No.31
Reference counter capacity	10000	No.180

<4> Set initialization bit DGPR to 0.

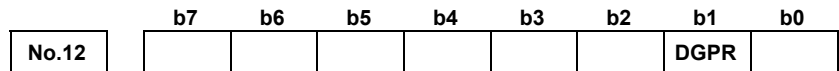

When this bit is set to 0, a power disconnection request alarm (alarm No. 0) is issued. However, 5 to 9 below can be set.

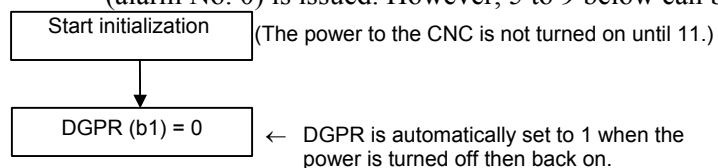

- <5> Set a motor type number.
In parameter No. 125, set the motor type number of the servo motor to be used.

SVM1-4i

Motor model	$\beta 0.2/5000is$	$\beta 0.3/5000is$
Motor specification	0111	0112
Motor type number	260	261

SVM1-20i

Motor model	$\alpha 1/5000i$	$\beta 2/4000is$	$\alpha 2/5000i$	$\beta 4/4000is$	$\beta 8/3000is$
Motor specification	0202	0061	0205	0063	0075
Motor type number	252	253	255	256	258
Motor model	$\alpha 2/5000is$	$\alpha 4/5000is$	$\alpha C4/3000i$	$\alpha C8/2000i$	$\beta 0.4/5000is$
Motor specification	0212	0215	0221	0226	0114
Motor type number	262	265	271	276	280
Motor model	$\beta 0.5/5000is$	$\beta 1/5000is$	$\alpha C12/2000i$		
Motor specification	0115	0116	0241		
Motor type number	281	282	291		

SVM1-40i

Motor model	$\beta 12/3000is$	$\alpha 4/4000i$	$\beta 22/2000is$	$\alpha 8/3000i$	$\alpha C22/2000i$
Motor specification	0078	0223	0085	0227	0246
Motor type number	272	273	274	277	296

SVM1-80i

Motor model	$\alpha 8/4000is$	$\alpha 12/4000is$	$\alpha 12/3000i$	$\alpha 22/3000i$	$\alpha C30/1500i$
Motor specification	0235	0238	0243	0247	0251
Motor type number	285	288	293	297	301

- <6> Set CMR.
In parameter No. 32, set a factor by which the amount of travel specified in the CNC is multiplied for the servo system.

CMR = Command unit/detection unit

When CMR is 1 to 48	Setting = CMR x 2
---------------------	-------------------

When CMR is 1/2 to 1/27	Setting = 1/CMR + 100
-------------------------	-----------------------

Usually, CMR = 1. So, set 2.

<7> Set the number of pulses per revolution

The number of pulses per revolution is calculated with reduction ratios or leads of the ball screws and detection unit.

(Number of pulses per motor revolution)

= (amount of travel per motor revolution) / (detection unit)

$$\frac{\text{Numerator for the number of pulses per rotation}}{\text{Denominator for the number of pulses per rotation}} = \frac{(\text{Parameter No. 105}) (\leq 32767)}{(\text{Parameter No. 106}) (\leq 32767)}$$

$$= \frac{(\text{Parameter No. 179}) (> 32767)}{(\text{Parameter No. 106}) (\leq 32767)}$$

Example of setting)

Example: 10 μ m detection in semi-closed loop

Ball screw lead	Number of pulses per rotation Numerator/denominator
10 (mm/rev)	10mm/10 μ m=1000/1
20 (mm/rev)	20mm/10 μ m=2000/1
30 (mm/rev)	30mm/10 μ m=3000/1

Example of setting)

1/100 degree detection with a deceleration ratio of 10:1 for a rotation axis

Every time the motor makes one rotation, the table rotates through 360/10 degrees. The number of pulses per motor rotation is 360/10 \div (1/100) = 3600 pulses, so set the following: Numerator = 3600, Denominator = 1

<8> Set the direction of motor travel in parameter No. 31.

111	Clockwise as viewed from the pulse coder
-111	Counterclockwise as viewed from the pulse coder

<9> Set the reference counter capacity. (Parameter No. 180)

Set the reference counter capacity when performing a reference position return operation based on the grid method. Set the number of position pulses per motor rotation, or set that number divided by an integer.

Example of setting)

α i pulse coders, semi-closed loop (1 μ m detection)

Ball screw lead	Number of pulses per motor revolution	Reference counter	Grid width
10mm/revolution	10000/1	10000	10mm
20	20000/1	20000	20mm
30	30000/1	30000	30mm

<10>Turn off/on both CNC and servo amplifier module and servo parameter initialization is finished.
This completes servo parameter initialization.

<11>If you use αi pulse coder as an absolute pulse coder, some procedures described below are needed.

- 1 Set the following parameter, then turn off / on the host CNC and servo amplifier module.

		b7	b6	b5	b4	b3	b2	b1	b0
No.11	APCX								ABSX
APCX (#7)	Absolute position detector is 0 : not used 1 : used								
ABSX (#0)	Position of machine and position of absolute pulse coder is 0 : not matched 1 : matched								

- 2 Make sure that a battery is connected to the absolute pulse coder, and turn the power to the host CNC and servo amplifier module off and on again.
- 3 A reference position return request is indicated.
- 4 Rotate the servo motor through one or more rotations by jogging and so on.
- 5 Turn the power to the host CNC and servo amplifier module off, then back on again.
- 6 CNC requires the reference position return again.
- 7 Perform reference position return. The ABSX is set to 1 after finishing the reference position return.

4

CONFIRMATION OF THE OPERATION

4.1 CHECK PROCEDURE

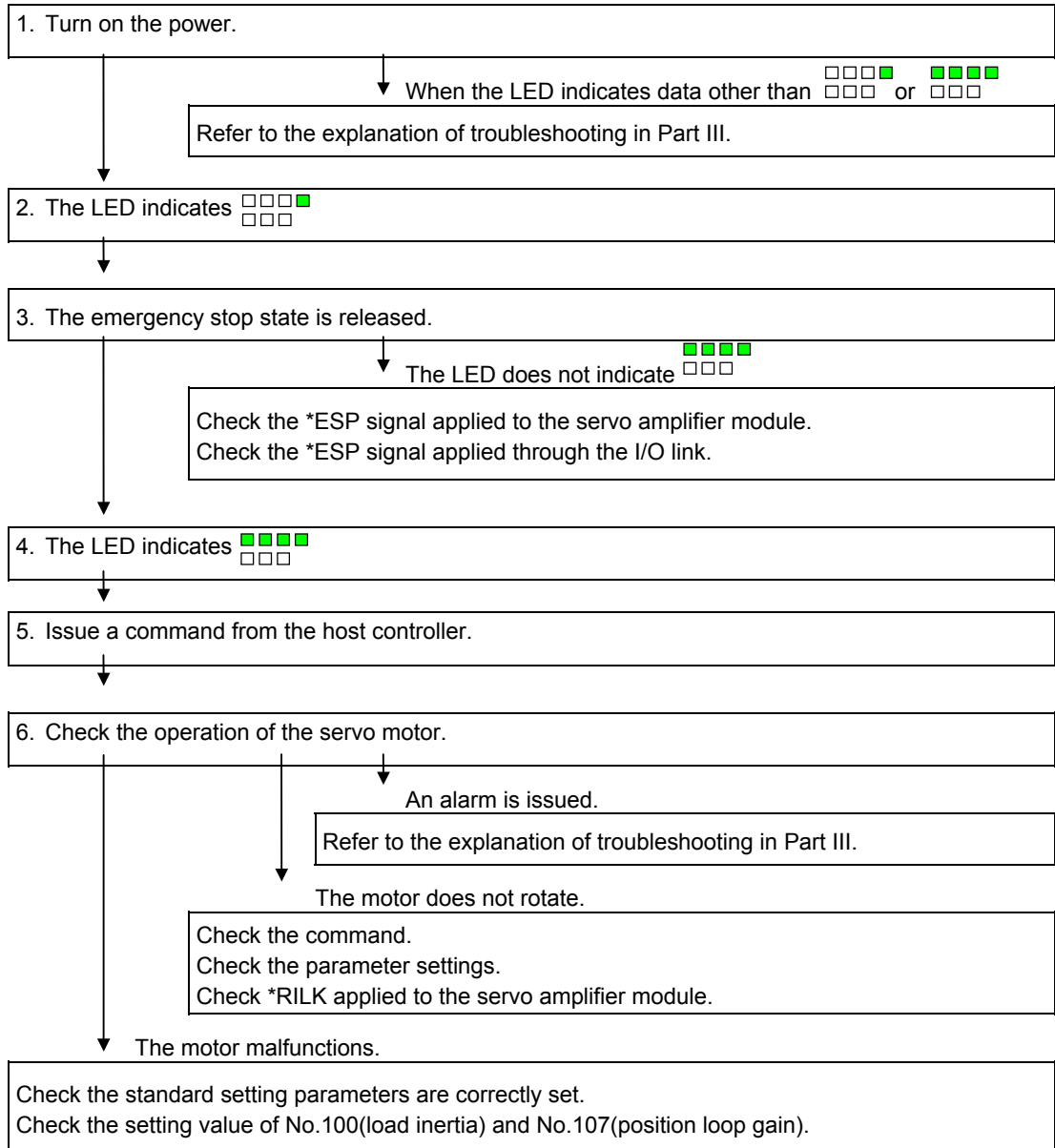
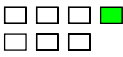
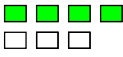
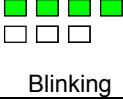
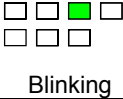
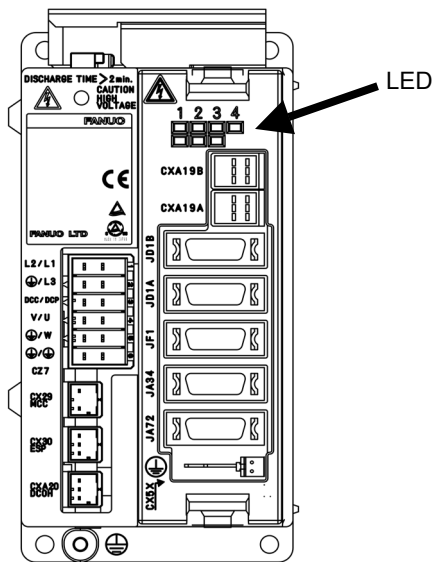
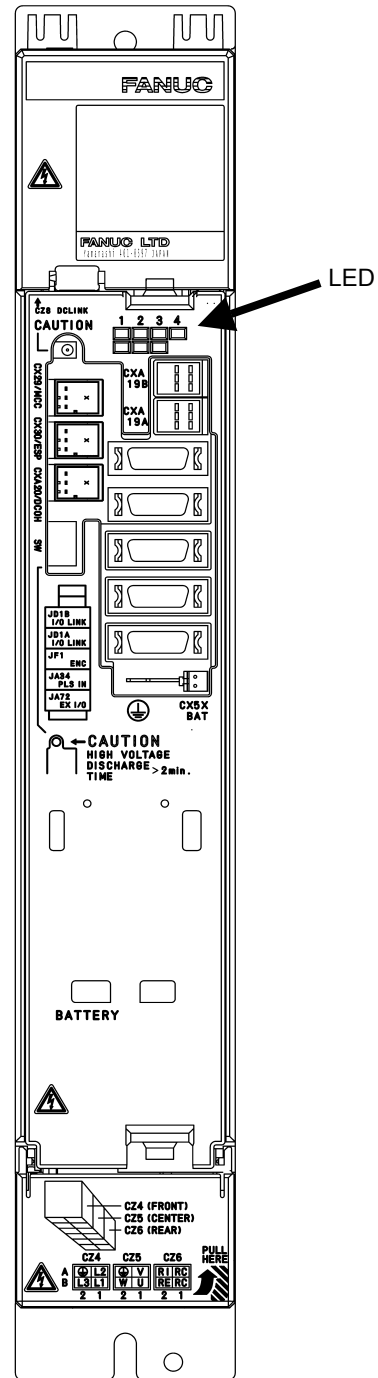

Table 4.1 LED Indications and Meanings

LED indication	State	Description
	Servo amplifier module not ready	This indicates that control power (+24 VDC) is supplied. No alarm is issued, but the motor is not activated.
	Servo amplifier module ready	This indicates that the motor is activated, and that commands can now be accepted.
	Command being executed	This indicates that an accepted command is now being executed.
	Parameters being loaded	This indicates that parameters are being loaded in a batch from the power mate CNC manager.
Indication other than the above	Alarm	An alarm is issued. For information about alarms, see the explanation of troubleshooting in Part III.



4/20A



40/80A

5

PERIODIC MAINTENANCE OF SERVO AMPLIFIER

5.1 BATTERY FOR THE ABSOLUTE PULSECODER

The battery unit for the absolute Pulsecoder can be connected using [Connection scheme 1] and [Connection scheme 2] explained below.

[Connection scheme 1]

Supplying power from one battery unit to more than one SVM

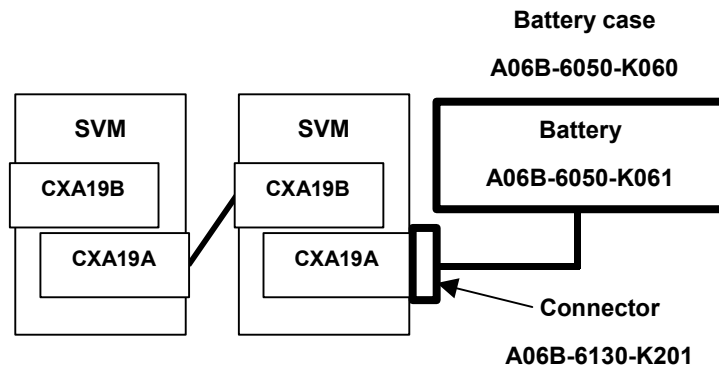

- If a low battery voltage or a battery voltage of 0 V is indicated by an APC (absolute Pulsecoder) alarm, replace the battery.
If a battery voltage of 0 V is indicated, you need to make a zero point return.
If a battery voltage of 0 V is indicated, you need to make a zero point return.
- The absolute Pulsecoder of the β is series servo motor (β 0.4/5000is to β 22/2000is) is incorporated with a backup capacitor as standard. This backup capacitor enables an absolute position detection to be continued for about 10 minutes. Therefore, no zero point return need be performed if the time during which servo amplifier power is kept off for battery replacement is within 10 minutes.
The Pulsecoder of the β series servo motors and some of the β is series servo motors (β 0.2/5000is to β 0.3/5000is) does not include a backup capacitor. Be careful when replacing the battery for this Pulsecoder. See [Caution No. 1 for battery replacement] at the end of this section for details.
- The battery service life is about two years for the β is series servo motors (β 0.4/5000is to β 22/2000is) if servo motors for six axes are connected. For the β series servo motors and some of the β is series servo motors (β 0.2/5000is to β 0.3/5000is), the battery service life is about one year.
FANUC recommends that you replace the batteries periodically according to the battery service life.
- The battery unit consists of four R20 alkaline batteries. Commercial batteries can be used in the battery unit. The optional battery offered by FANUC is A06B-6050-K061.

 **WARNING**

- 1 Do not connect more than one battery to the same BAT (B3) line. If the output voltage is different between the batteries, they may be short-circuited, resulting in the batteries becoming very hot.
- 2 Install the battery with correct polarity. If the battery is installed with incorrect polarity, it may overheat, blow out, or catch fire.

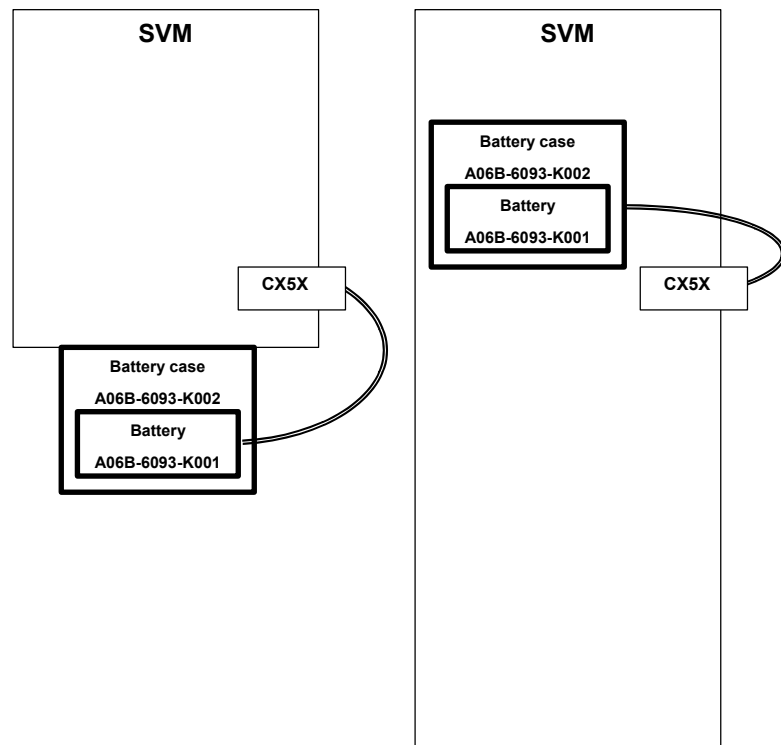
[Connection scheme 2] Incorporating each SVM with batteries

- If a low battery voltage or a battery voltage of 0 V is indicated by an APC (absolute Pulsecoder) alarm, replace the battery (A06B-6073-K001).
If a battery voltage of 0 V is indicated, you need to make a zero point return.
- The absolute Pulsecoder of the βis series servo motor ($\beta 0.4/5000is$ to $\beta 22/2000is$) is incorporated with a backup capacitor as standard. This backup capacitor enables an absolute position detection to be continued for about 10 minutes. Therefore, no zero point return need be performed if the time during which servo amplifier power is kept off for battery replacement is within 10 minutes.
The Pulsecoder of the β series servo motors and some of the βis series servo motors ($\beta 0.2/5000is$ to $\beta 0.3/5000is$) does not include a backup capacitor. Be careful when replacing the battery for this Pulsecoder. See [Caution No. 1 for battery replacement] at the end of this section for details.
- The battery service life is about two years for the βis series servo motors ($\beta 0.4/5000is$ to $\beta 22/2000is$). For the β series servo motors and some of the βis series servo motors ($\beta 0.2/5000is$ to $\beta 0.3/5000is$), the battery service life is about one year. FANUC recommends that you replace the batteries periodically according to the battery service life.
- The built-in batteries are not commercially available. They must be purchased from FANUC. So, FANUC recommends that you keep spares.

⚠ WARNING

- 1 When using the built-in batteries (A06B-6093-K001), do not connect them to the BAT (B3) of connector CXA19A/CXA19B. The output voltages from different SVM batteries may be short-circuited, resulting in the batteries becoming very hot.
- 2 Do not connect more than one battery to the same BAT (B3) line. If the output voltage is different between the batteries, they may be short-circuited, resulting in the batteries becoming very hot.

- Installation procedure for the battery

· SVM1-4*i*, SVM1-20*i*

- (1) Install the battery in the SVM.
- (2) Install the battery cover.
- (3) Attach the battery connector to CX5X of the SVM.

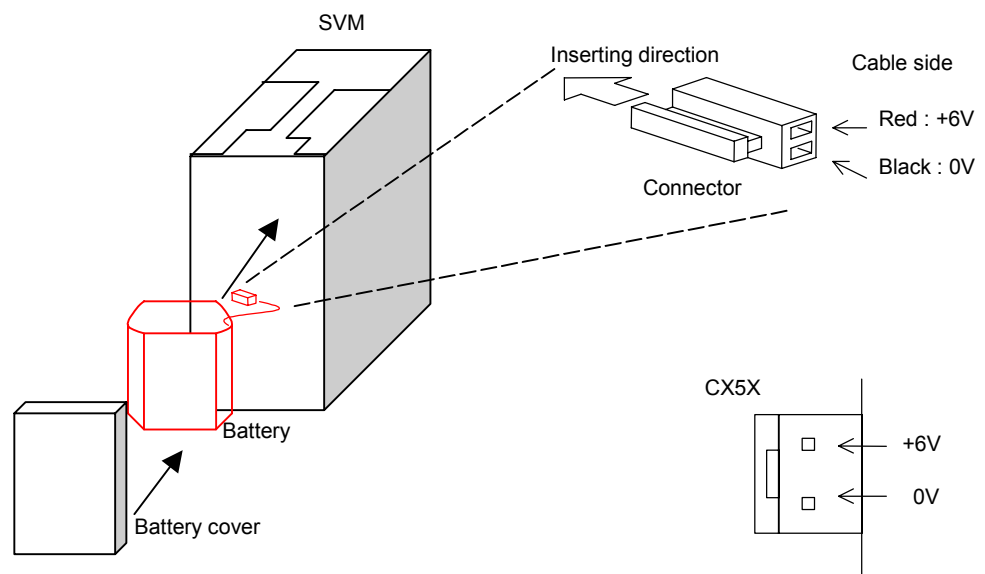

· SVM1-40i, SVM1-80i

- (1) Install the battery in the SVM.
- (2) Install the battery cover.
- (3) Attach the battery connector to CX5X of the SVM.

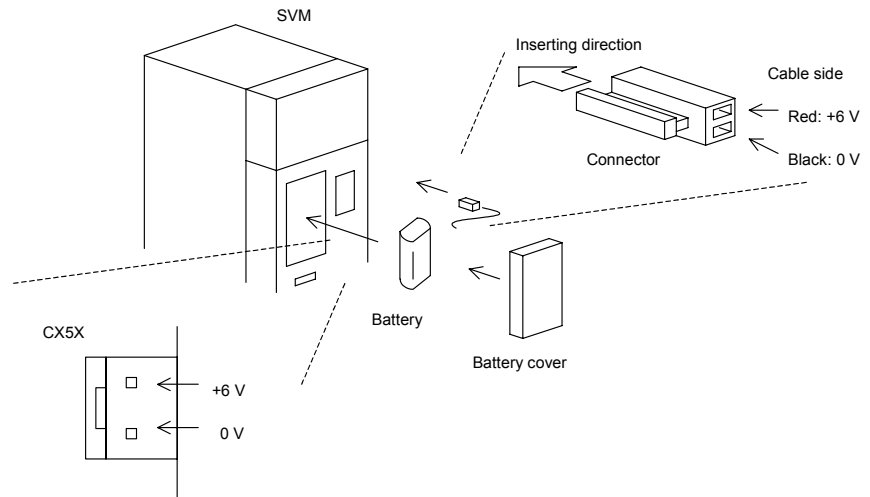
**⚠ CAUTION**

- 1 When the battery is installed in the SVM from the side from which the cable is drawn, the cable may be stretched tight, which can lead to a poor contact condition. Therefore, install the battery so that the cable is not extended tightly.
- 2 Be careful when handling the connector. See [Caution No. 2 for battery replacement] at the end of this section for details.

[Caution No. 1 for battery replacement]

The Pulsecoder of the β series servo motors and some of the β is series servo motors ($\beta 0.2/5000is$ to $\beta 0.3/5000is$) does not include a backup capacitor as standard. To keep the absolute position information in the absolute Pulsecoder, you need to keep the control power turned on during battery replacement. Follow the procedure explained below.

[Replacing procedure for the battery]

1. Make sure that the power to the SVM is on (the LED "POWER" on the front of the SVM is on).
2. Make sure that the emergency stop button of the system has been pressed.
3. Make sure that the motor is not activated.
4. Make sure that the DC link charge LED of the SVM is off.
5. Remove the old battery, and install a new battery.
6. This completes the replacement. You can turn off the power to the system.

 WARNING

- 1 When replacing the battery, be careful not to touch bare metal parts in the panel. In particular, be careful not to touch any high-voltage circuits due to the electric shock hazard.
- 2 Before replacing the battery, check that the DC link charge confirmation LED on the front of the servo amplifier is off. Neglecting this check creates an electric shock hazard.
- 3 Install the battery with correct polarity. If the battery is installed with incorrect polarity, it may overheat, blow out, or catch fire.
- 4 Avoid a short-circuit between the +6 V and 0 V lines of a battery or cable. A short-circuit may lead to a hot battery, an explosion, or fire.

[Caution No. 2 for battery replacement]

If an excessive strain is applied to a connector when it is inserted or removed, a poor contact may result. When inserting and removing the battery connector, therefore, be careful not to apply an excessive wrenching force to it; just follow the instructions given in the following table.

(1) Attaching connectors

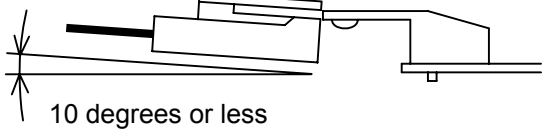
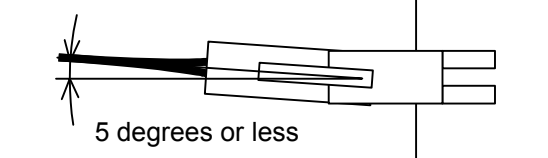
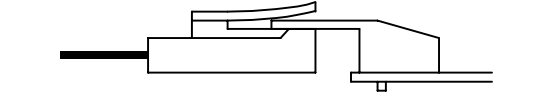
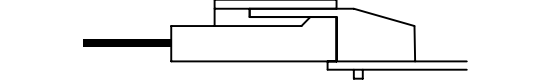
<1>		Check the attachment position.
<2>	 <p>10 degrees or less</p>	Plug the cable connector while raising it slightly.
<5>	 <p>5 degrees or less</p>	Here, the angle of the cable connector to the horizontal must be 5 degrees or less.
<3>		After passing the lock pin, insert the connector straight.
<4>		The attachment of the connector is completed.

(2) Detaching the connector

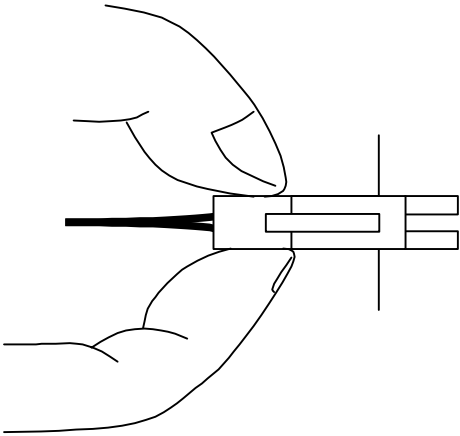
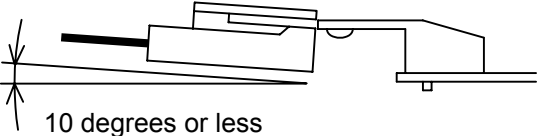
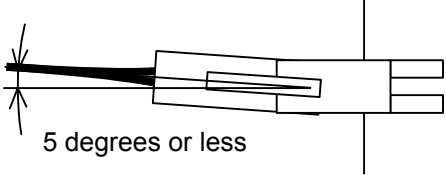
<p><1></p>		<p>Hold both the sides of the cable insulator and the cable, and pull them horizontally.</p>
<p><2></p>	 <p>10 degrees or less</p>	<p>Pull out the cable side while raising it slightly.</p>
<p><3></p>	 <p>5 degrees or less</p>	<p>Here, the angle of the cable to the horizontal must be 5 degrees or less.</p>

5.2 PERIODIC MAINTENANCE OF SERVO AMPLIFIER

To use the servo amplifier for a long time and keep its high performance and reliability, you should perform maintenance and inspection on it routinely.

Inspection target	Inspection item	Inspection cycle		Criterion	Remark
		Routine	Periodic		
Environment	Ambient temperature	O		Surroundings of the power magnetics cabinet: 0 to 45 °C Inside of power magnetics cabinet: 0 to 55 °C	
Environment	Humidity	O		90%RH or lower (no condensation allowed)	
Environment	Dust Oil mist	O		No dust or oil mist shall be on and around the servo amplifier.	
Environment	Cooling air path	O		Whether the cooling air path is free from an obstacle. Whether the cooling fan motor is working.	
Environment	Abnormal vibration and noise	O		(1) There shall be no abnormal sound or vibration that has not be experienced so far. (2) Any vibration on and around the amplifier shall not be over 0.5 G.	
Environment	Power supply voltage	O		3-phase input : Shall be within the rating (200 to 240 V). Single-phase input : Shall be within the rating (220 to 240 V).	
Amplifier	General	O		Whether the amplifier generates abnormal sound or odor.	
Amplifier	General	O		Whether there is dust or oil mist on the amplifier. Whether the amplifier generates abnormal sound or odor.	
Amplifier	Screw		O	There shall be no loose screw.	
Amplifier	Fan motor	O		(1) Whether the motor is running normally. (2) The motor shall not generate abnormal vibration or sound. (3) There shall be no dust or oil mist on the motor.	(*1)
Amplifier	Connector		O	Whether there is a loose connector.	
Amplifier	Cable		O	(1) Whether there is a sign of past heat generation. (2) Whether there is a deteriorated sheath (discolored or cracked).	
External device	Magnetic contactor		O	The magnetic contactor shall not rattle or chatter.	
External device	Ground fault interrupter		O	The interrupter shall be able to trip.	
External device	AC line filter		O	There shall be no hum.	

(*1) Generally, fan motors are periodic-replacement parts.

If a fan motor for a servo amplifier does not work, the amplifier will not get broken immediately. However, you should inspect the fan motor constantly and replace it in a preventive manner.

Specification number of fan unit**- SVM**

SVM name	Fan for circulating the inside air		Fan for cooling external heat sink fins	
	Fan unit (*1)	Fan motor	Fan unit (*1)	Fan motor
SVM1-4i SVM1-20i	-	A90L-0001-0423#50	-	-
SVM1-40i	A06B-6110-C605	A90L-0001-0510	-	-
SVM1-80i	A06B-6110-C605	A90L-0001-0510	A06B-6134-K002	-

(*1) A fan unit is a set of a fan motor and a cover for mounting it.

II. HANDLING

1

OVERVIEW

1.1 SERVO AMPLIFIER MODULE INTERFACE

The servo amplifier module is connected to a host unit such as a CNC via 128 DI and 128 DO points of the FANUC I/O Link. The ladder program on the host unit sends move commands to the servo amplifier module and monitors its status, via this interface.

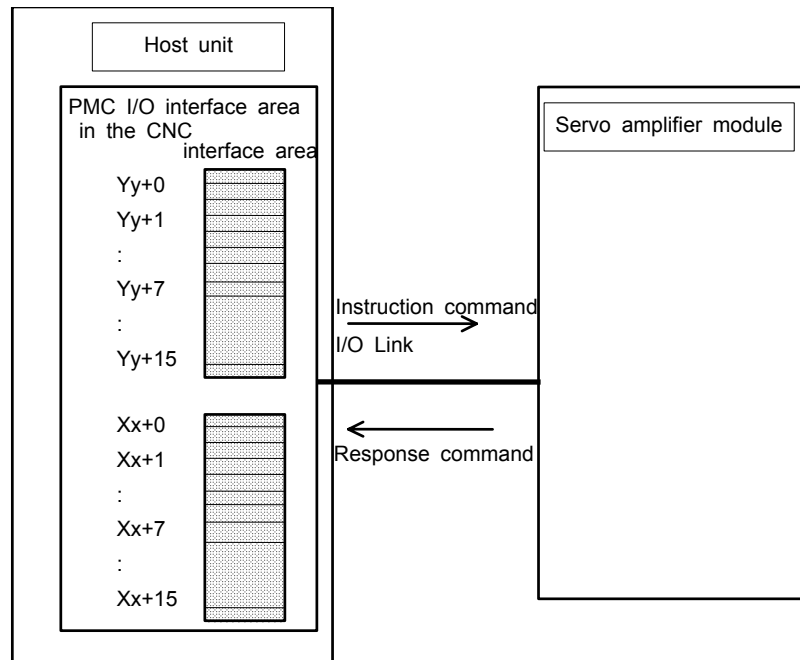

1.2 FANUC I/O Link INTERFACE AREA

The interface area used to transfer data via the FANUC I/O Link is divided into two sections: A signal area for handling reset and alarm signals, and a command code area for handling move commands and status monitor command code.

The host unit can directly read- and write-access the signal area. So it can be used to select the interface mode, start/stop operations, and monitor for alarm conditions.

The command code area can be used to issue commands to servo amplifier modules by combining function code and command data. For example, it is possible to send absolute/incremental move command and reference position return move command blocks, and receive the current position data.

1.3 INTERFACE

Interfaces are used to transfer data to and from the servo amplifier module.

Essentially, there are two operation modes: Peripheral equipment control interface and direct command interface. The mode to be used is selected by the DRC signal in the signal area.

1.3.1 Peripheral Equipment Control Interface

This interface offers a high degree of compatibility with the peripheral equipment control functions of the Power Mate-E. It is provided with commands that can be used to control the peripheral equipment of machine tools. It enables the implementation of a series of positioning operations, such as axis clamp/unclamp, with a single command. This interface is useful if a ladder program, created based on this interface, is already available.

1.3.2 Direct Command Interface

This interface is used to implement a positioning operation with a single command, unlike peripheral equipment control, in which a single command can perform multiple operations. Besides a positioning command, this interface offers commands such as wait, parameter read/write, and diagnosis data read commands, enabling a wide range of operations can be implemented.

The two interface modes can be switched during operation. Interface switching causes the meaning of signals to be changed, requiring complicated ladder program logic. So, it is recommended that the interface mode not be changed during a servo amplifier module control sequence.

1.3.3 Interface Switching

Either peripheral equipment control or direct command interface mode is available depending on the situation. Usually, interface switching is not performed while the power is on. When necessary, however, the host can switch the interface by issuing a DRC signal.

When the DRC signal is 0, the peripheral equipment control interface is selected. When it is 1, the direct command interface is selected.

When the DRCO signal is 0, response data received from the servo amplifier unit indicates the peripheral equipment control interface. When it is 1, the response data indicates the direct command interface.

DRC signal switching must be performed during a reset state. Signal switching causes the meaning of a signal in use to be changed. Be careful when a command is being issued or axis movement is occurring, as signal switching may result in unexpected behavior.

Once the DRC signal is switched, defer issuing a command until one scan after the DRCO signal is switched. If the DRC signal is inverted again before the DRCO signal is switched, it may become impossible to exchange data with the servo amplifier module normally. Before inverting the DRC signal again, wait for at least one scan after the DRCO signal is switched.

1.4 CAUTIONS ON USING THE POWER MATE CNC

When the direct command interface is selected, using a Power Mate CNC manager function at the same time causes the area for response commands (Xx+4 to Xx+15) to be shared by the PMC and the manager. For this reason, it is necessary to distinguish between the response commands for their respective instruction commands and receive only those response commands for the PMC of the host. "USR1" in a response command is used to determine whether it is for the PMC or the manager.

If "USR1" is "0", the response command is for the PMC of the host and the PMC can receive it; if "USR1" is "1", it is for the Power Mate CNC manager and the PMC must ignore it.

2

SIGNAL DESCRIPTIONS

2.1 DO/DO SIGNALS

A host unit such as a CNC is connected to the servo amplifier module via 128 DI and 128 DO points of the FANUC I/O Link.

⚠ CAUTION
I/O link interface signal assignment differs between the peripheral equipment control and direct command interfaces.

2.1.1 Peripheral Equipment Control Interface

Locations Yy+0, Yy+1, and Yy+7 are allocated as the DO signal area, while locations Xx+0, Xx+1, Xx+2, and Xx+7 are allocated as the DI signal area. To control the servo amplifier module, it is necessary to turn on or off directly those signals that are assigned to these areas of read them.

For the command code area, the function code and command data 1 are assigned to location Yy+2, and command data 2 is assigned to locations Yy+3 to Yy+6. Command issue to the servo amplifier module must be done using these locations. Also, response commands are assigned to locations Xx+3 to Xx+6; receive the response data for instruction commands.

CNC (host) → Servo amplifier module (DRC=0)								
	7	6	5	4	3	2	1	0
Yy+0	ST	UCPS2	-X	+X	DSAL	MD4	MD2	MD1
Yy+1			DRC	ABSRD	*ILK	SVFX	*ESP	ERS
Yy+2	Function code				Command data 1			
Yy+3	Command data 2							
Yy+4								
Yy+5								
Yy+6								
Yy+7	RT	DRN	ROV2/MP2	ROV1/MP1	*OV8	*OV4	*OV2	*OV1
Yy+8	Unusable (System reserved area)							
Yy+9								
Yy+10								
Yy+11								
Yy+12								
Yy+13								
Yy+14								
Yy+15								

Servo amplifier module → CNC (host) (DRC=0)

	7	6	5	4	3	2	1	0
Xx+0	OPC4	OPC3	OPC2	OPC1	INPX	SUPX	IPLX	DEN2
Xx+1	OP	SA	STL	UCPC2	OPTENB	ZRFX	DRCO	ABSWT
Xx+2	MA	AL	DSP2	DSP1	DSALO	TRQM	RST	ZPX
Xx+3	Response data							
Xx+4								
Xx+5								
Xx+6								
Xx+7	SVERX			PSG2	PSG1	MVX	APBAL	MVDX
Xx+8	Unusable (Power mate CNC manager response area)							
Xx+9								
Xx+10								
Xx+11								
Xx+12								
Xx+13								
Xx+14								
Xx+15								

See Section 2.3 for details of the signals. Section 3.3 explains the function code, command data, and response data.

⚠ CAUTION

In the past, the "V READY OFF alarm ignore signal (IGNVRY<Yy+1#6>)" existed. When the servo amplifier module is normal, however, V READY OFF alarm (No. 401) is not issued. This signal is, therefore, deleted. If this signal was used in the ladder program, delete it.

NOTE

#4 and #5 of Yy+7 are used by both the rapid traverse override signal (ROV1 and ROV2) and the incremental feed signal (MP1 and MP2). If bit 5 (MP) of parameter No. 5 is "1" and the system is in manual handle mode, they are for the incremental feed signal, and if MP is "0" or the system is not in manual handle mode, they are for the rapid traverse signal. If MP is "1", before switching from manual handle mode to another mode, the signal must be returned to such a setting that the bits are for the rapid traverse override signal.

2.1.2 Direct Command Interface

Locations Yy+0 to Yy+3 are allocated as the DO signal area, while locations Xx+0 to Xx+3 are allocated as the DI signal area. To control the servo amplifier unit, turn on or off directly those signals that are assigned to these areas or read them.

In the "instruction command area", direct commands (instruction commands) are assigned to locations Yy+4 to Yy+15, which are used to send commands to the servo amplifier module. Also, direct commands (response commands) are assigned to locations Xx+4 to Xx+15; receive the response commands for instruction commands.

CNC (host) → Servo amplifier module (DRC=1)

	7	6	5	4	3	2	1	0
Yy+0	ST		-X	+X		MD4	MD2	MD1
Yy+1			DRC	WFN	*ILK	SVFX	*ESP	ERS
Yy+2	RT	DRN	ROV2	ROV1	*OV8	*OV4	*OV2	*OV1
Yy+3	INPF							
Yy+4	EBUF	EOREND						ECNT
Yy+5	Direct command (function code)							
Yy+6	Direct command (command data 1)							
Yy+7	Direct command (command data 2)							
Yy+8	Direct command (command data 3)							
Yy+9	Direct command (command data 4)							
Yy+10	Direct command (command data 5)							
Yy+11	Direct command (command data 6)							
Yy+12	Direct command (command data 7)							
Yy+13	Direct command (command data 8)							
Yy+14	Direct command (command data 9)							
Yy+15	Direct command (command data 10)							

CAUTION

In the past, the "V READY OFF alarm ignore signal (IGNVRY<Yy+1#6>)" existed. When the servo amplifier module is normal, however, V READY OFF alarm (No. 401) is not issued. This signal is, therefore, deleted. If this signal was used in the ladder program, delete it.

Servo amplifier module → CNC (host) (DRC=1)

	7	6	5	4	3	2	1	0
Xx+0					INPX	SUPX	IPLX	DEN2
Xx+1	OP	SA	STL		OPTENB	ZRFX	DRCO	WAT
Xx+2	MA	AL				TRQM	RST	ZPX
Xx+3	INPFO	SVERX		PSG2	PSG1	MVX	APBAL	MVDX
Xx+4	EBSY	EOSTB	ECF		USR1	EOPC	DAL	ECONT
Xx+5	Direct command (function code)							
Xx+6	Reserved				Execution result			
Xx+7	Direct command (response data 1)							
Xx+8	Direct command (response data 2)							
Xx+9	Direct command (response data 3)							
Xx+10	Direct command (response data 4)							
Xx+11	Direct command (response data 5)							
Xx+12	Direct command (response data 6)							
Xx+13	Direct command (response data 7)							
Xx+14	Direct command (response data 8)							
Xx+15	Direct command (response data 9)							

See Section 2.3 for details of the signals. Section 4.4 explains the function number, command data, and response data.

2.2 SIGNALS (LISTED IN GROUPS)

- * The following lists not only signals transferred via the I/O link interface but also direct input/output signals such as *ESP, *-OT, *+OT, *RILK, *DEC, and HDI.
- * Each listed address is based on the I/O link assignment address of each slave of the host.

Function list

Group	Signal name	Symbol	Address		Reference item
			Peripheral equipment	Direct command	
1	Preparation completion signal	MA	Xx+2#7		2.3.1
	Servo preparation completion signal	SA	Xx+1#6		2.3.1
2	Emergency stop signal	*ESP	Yy+1#1		2.3.2
	External reset signal	ERS	Yy+1#0		2.3.2
	Reset in-progress signal	RST	Xx+2#1		2.3.2
3	Alarm signal	AL	Xx+2#6		2.3.3
	Absolute pulse coder battery alarm signal	APBAL	Xx+7#1	Xx+3#1	2.3.3
4	Mode selection signal	MD4,MD2,MD1	Yy+0#0 to Yy+0#2		2.3.4
5	Feed axis and direction selection signal	+X,-X	Yy+0#4,Yy+0#5		2.3.5
6	Remaining travel in-range signal	DEN2	Xx+0#0		2.3.6
	Distribution pulse signal	IPLX	Xx+0#1		2.3.6
	Acceleration/deceleration pulse signal	SUPX	Xx+0#2		2.3.6
	In-position signal	INPX	Xx+0#3		2.3.6
	Servo positional deviation monitor signal	SVERX	Xx+7#6	Xx+3#6	2.3.6
	Axis movement in-progress signal	MVX	Xx+7#2	Xx+3#2	2.3.6
	Movement direction signal	MVDX	Xx+7#0	Xx+3#0	2.3.6
	Area signal	PSG1,PSG2	Xx+7#3,Xx+7#4	Xx+3#3,Xx+3#4	2.3.6
	Speed control in-progress signal	TRQM	Xx+2#2		2.3.6
	Function enable signal	OPTENB	Xx+1#3		2.3.6
7	Feedrate override signal	*OV1 to *OV8	Yy+7#0 to Yy+7#3	Yy+2#0 to Yy+2#3	2.3.7
	Manual rapid traverse selection signal	RT	Yy+7#7	Yy+2#7	2.3.7
	Rapid traverse override signal	ROV1,ROV2	Yy+7#4,Yy+7#5	Yy+2#4,Yy+2#5	2.3.7
	Incremental feed signal	MP1, MP2	Yy+7#4,Yy+7#5	--	2.3.7
8	Interlock signal	*ILK	Yy+1#3		2.3.8
9	Reference position return completion signal	ZPX	Xx+2#0		2.3.9
	Reference position establishment signal	ZRFX	Xx+1#2		2.3.9
10	Automatic operation start signal	ST	Yy+0#7		2.3.10
	Automatic operation start in-progress signal	STL	Xx+1#5		2.3.10
	Automatic operation signal	OP	Xx+1#7		2.3.10
	Dry run signal	DRN	Yy+7#6	Yy+2#6	2.3.10

Group	Signal name	Symbol	Address		Reference item
			Peripheral equipment	Direct command	
11	Unclamp command signal	UCPC2	Xx+1#4	--	2.3.11
	Clamp/unclamp state output signal	UCPS2	Yy+0#6	--	2.3.11
12	Servo-off signal	SVFX	Yy+1#2		2.3.12
13	Operation completion signal	OPC1, OPC2, OPC3, OPC4	Xx+0#4 to Xx+0#7	--	2.3.13
	Function code	CMD CODEP	Yy+2#4 to Yy+2#7	--	2.3.13
	Command data 1	CMD DATA1	Yy+2#0 to Yy+2#3	--	2.2.13
	Command data 2	CMD DATA2	Yy+3 to Yy+6	--	2.3.13
	Response data	ANS DATAP	Xx+3 to Xx+6	--	2.3.13
	Response data check signal	DSP1, DSP2	Xx+2#4 to Xx+2#5	--	2.3.13
	Response data write completion signal	ABSWT	Xx+1#0	--	2.3.13
	Response data read completion signal	ABSRD	Yy+1#4	--	2.3.13
	Alarm output command signal	DSAL	Yy+0#3	--	2.3.13
Alarm output state check signal	DSALO	Xx+2#3	--	2.3.13	
14	Function code command strobe signal	EBUF	--	Yy+4#7	2.3.14
	Function code command read completion signal	EBSY	--	Xx+4#7	2.3.14
	Function code	CMD CODE	--	Yy+5	2.3.14
	Command data	CMD DATA	--	Yy+6 to Yy+15	2.3.14
	Response data	ANS DATA	--	Xx+7 to Xx+15	2.3.14
	Continuously output data signal	EOPC	--	Xx+4#2	2.3.14
	Response data readable signal	EOSTB	--	Xx+4#6	2.3.14
	Response data read completion signal	EOREND	--	Yy+4#6	2.3.14
	Command continuation notification signal	ECNT	--	Yy+4#0	2.3.14
	PMM data signal	USR1	--	Xx+4#3	2.3.14
	Response data continuation notification signal	ECONT	--	Xx+4#0	2.3.14
	Function code command completion notification signal	ECF	--	Xx+4#5	2.3.14
	Alarm signal	DAL	--	Xx+4#1	2.3.14
	Wait signal	WAT	--	Xx+1#0	2.3.14
	Wait completion signal	WFN	--	Yy+1#4	2.3.14
	Memory registration signal	INPF	--	Yy+3#7	2.3.14
Memory registration in-progress signal	INPFO	--	Xx+3#7	2.3.14	
Interface switch signal	DRC	--	Yy+1#5	2.3.14	
Interface status notification signal	DRCO	--	Xx+1#1	2.3.14	
15	Emergency stop signal	*ESP	Direct input		2.3.15
	Overtravel signal	*-OT, *+OT	Direct input		2.3.15
	High-speed interlock signal	*RILK	Direct input		2.3.15
	Deceleration signal for reference position return	*DEC	Direct input		2.3.15
	Skip signal	HDI	Direct input		2.3.15

2.3 SIGNAL DETAILS

2.3.1 Preparation Completion

(1) Preparation completion signal MA

- [Classification] Input signal <Xx+2#7> (common to both the peripheral equipment control and direct command interfaces)
- [Function] This signal indicates that the servo amplifier module is ready to operate.
- [Input condition] The signal becomes 1 when:
1. Self-diagnosis in the servo amplifier module completes normally when the power is switched on.
- The signal becomes 0 when:
1. The power to the servo amplifier module is switched off.
 2. A control unit error such as a CPU or memory failure is detected.

(2) Servo preparation completion signal SA

- [Classification] Input signal <Xx+1#6> (common to both the peripheral equipment control and direct command interfaces)
- [Function] This signal indicates that the servo amplifier module is ready to operate. Conversely, if this signal is not issued, the servo amplifier module is not operating.
- [Input condition] The signal becomes 1 when:
1. Self-diagnosis in the servo system completes normally when the power to the control unit is switched on.
 2. A servo alarm (if any has occurred) is reset.
 3. An emergency stop condition (if any has occurred) is reset.
- The signal becomes 0 when:
1. The power to the control unit is switched off.
 2. A servo alarm condition is detected.
 3. An emergency stop is effected.

NOTE

In the servo-off state, the SA signal remains at 1 unless a condition which resets it to 0 occurs.

2.3.2 Reset and Emergency Stop

(1) Emergency stop signal *ESP

- [Classification] Output signal <Yy+1#1> (common to both the peripheral equipment control and direct command interfaces)
- [Function] This signal brings the control unit to an emergency stop.
- [Operation] When the signal becomes 0, the control unit operates as follows:
1. The control unit stops immediately during axis movement.
 2. A reset is applied after the stop.
 3. When the emergency stop signal is 0, the servo preparation completion signal SA is also 0, because the servo system is not operating. If axis movement occurs while the servo system is not operating, the amount of movement is reflected in the current position coordinates held in the control unit (follow-up).
 4. While the emergency stop signal is 0, jog and function code commands cannot be issued.

(2) External reset signal ERS

- [Classification] Output signal <Yy+1#0> (common to both the peripheral equipment control and direct command interfaces)
- [Function] This signal resets the servo amplifier module.
- [Operation] When the signal becomes 1, the servo amplifier module operates as follows:
1. The servo amplifier module immediately decelerates axis movement to a stop.
 2. After a stop, the servo amplifier module is reset, then the following are canceled:
 - Function code commands are canceled regardless of whether they are under execution, buffered, or on input signals.
 - In an alarm state, those alarms that can be canceled are canceled.
 3. While the external reset signal is 1, jog and function code commands cannot be issued.

(3) Reset in-progress signal RST

- [Classification] Input signal <Xx+2#1> (common to both the peripheral equipment control and direct command interfaces)
- [Function] This signal indicates that the control unit is being reset.
- [Input condition] The signal becomes 0 when:
1. A reset is completed.
- The signal becomes 1 when:
1. A reset is in progress.
- That is, the external reset signal ERS ((2) in Section 2.3.2) is 1, or the emergency stop signal *ESP ((1) in Section 2.3.2) is 0.

2.3.3 Alarm

(1) Alarm signal AL

[Classification]	Input signal <Xx+2#6> (common to both the peripheral equipment control and direct command interfaces)
[Function]	This signal indicates that the servo amplifier module is in an alarm state.
[Input condition]	The signal becomes 1 when: <ol style="list-style-type: none"> The servo amplifier module enters an alarm state. The following alarms can occur in the servo amplifier module. <ol style="list-style-type: none"> P/S alarm Pulse coder alarm Servo alarm Overtravel alarm <p>The signal becomes 0 when:</p> <ol style="list-style-type: none"> The servo amplifier module is released from an alarm state by a reset. Some alarms occur again after they are reset, unless their cause is removed. So, the AL signal is issued again immediately. In this case, the AL signal may become 0 for a moment.

(2) Absolute pulse coder battery alarm signal APBAL

[Classification]	Input signal <Xx+7#1> (peripheral equipment control interface) <Xx+3#1> (direct command interface)
[Function]	This signal indicates that the batteries of the absolute pulse coder require replacement.
[Input condition]	The signal becomes 1 when: <ol style="list-style-type: none"> The absolute pulse coder battery voltage is low. <p>The signal becomes 0 when:</p> <ol style="list-style-type: none"> The batteries are replaced, and the battery voltage becomes higher than or equal to the rating. This alarm will occur again after it is reset, unless the batteries are replaced. So, the APBAL signal is immediately issued again. In this case, the APBAL signal may become 0 for a moment.

CAUTION

Use this signal to display this battery alarm on the machine operator's panel. On the host controller, this battery alarm is not displayed if the power mate CNC manager screen is not displayed.

2.3.4 Mode Selection

(1) Mode selection signal MD1, MD2, MD4

[Classification] Output signal <Yy+0#0 to #2> (common to both the peripheral equipment control and direct command interfaces)

[Function] This signal selects an operation mode.

[Operation] The signal is a code signal consisting of three bits: MD1, MD2, and MD4. The code signal selects one of three modes: automatic operation (AUTO), handle feed (HANDLE), or jog (JOG), according to the combination of these bits.

MD4	MD2	MD1	Description
0	0	1	Automatic operation (AUTO)
1	0	0	Handle feed (HANDLE)
1	0	1	Jog feed by +X and -X (JOG)

CAUTION

Do not switch the operation mode during automatic operation. Stop automatic operation before switching the operation mode.

NOTE

See Section 3.10 or Chapter 5 for details of handle feed.

2.3.5 Jog Feed

(1) Feed axis and direction selection signals +X, -X

[Classification] Output signal <Yy+0#4,#5>(common to both the peripheral equipment control and direct command interfaces)

[Function] These signals select the direction in which jog feed movement (rotation) is to be performed, and cause it to be performed in the selected direction.

[Operation] The signals are valid when jog feed (JOG) mode is selected. They indicate the direction of feed. After JOG mode is selected, changing +X or -X, whichever is desired, from 0 to 1 causes and keeps movement in the corresponding direction at a feedrate specified by the override signals *OV1 to *OV8 ((1) of Subsection 2.3.7) or the manual rapid traverse selection signal RT ((2) of Subsection 2.3.7), provided the signal is 1.

NOTE

- 1 Simultaneously setting +X and -X to 1 results in neither direction being selected (equivalent to when both are 0).
- 2 If a feed axis selection signal becomes 1 before the jog feed signal (JOG) is selected, these signals are ignored. If the JOG signal is selected, it must be reset to 0 before the feed axis selection signal is set. The servo amplifier unit begins feeding when the JOG signal rises.

2.3.6 Status Signals

(1) Remaining travel in-range signal DEN2

- [Classification] Input signal <Xx+0#0> (common to both the peripheral equipment control and direct command interfaces)
- [Function] This signal indicates that, in the servo amplifier module, the number of axis move command distribution pulses that have not been used for axis movement (residual movement amount) is smaller than a parameter-specified value.
- [Input condition] The signal becomes 1 when:
1. The number of axis move command distribution pulses that have not been used for axis movement (residual movement amount) is smaller than a parameter-specified value.
- The signal becomes 0 when:
1. The number of axis move command distribution pulses that have not been used for axis movement (residual movement amount) is larger than a parameter-specified value.
 2. When the value of a parameter for the remaining travel in-range signal is 0.

NOTE

- 1 The DEN2 signal remains 0 during jog feed (JOG).
- 2 The DEN2 signal maintains its current state until another move command is issued.

(2) Distribution pulse signal IPLX

- [Classification] Input signal <Xx+0#1> (common to both the peripheral equipment control and direct command interfaces)
- [Function] This signal indicates that the servo amplifier module has axis move command distribution pulses that have not been used for axis movement (residual movement amount).
- [Input condition] The signal becomes 1 when:
1. There are axis move command distribution pulses that have not been used for axis movement (residual movement amount).
- The signal becomes 0 when:
1. There is no axis move command distribution pulse that has not been used for axis movement (residual movement amount).

NOTE

The IPLX signal is valid while jog feed (JOG) mode is set.

(3) Acceleration/deceleration pulse signal SUPX

- [Classification] Input signal <Xx+0#2> (common to both the peripheral equipment control and direct command interfaces)
- [Function] This signal indicates that the servo amplifier module has accumulated pulses in the acceleration/deceleration control section.
- [Input condition] The signal becomes 1 when:
1. Axis movement distribution pulses are accumulated in the acceleration/deceleration control section.
- The signal becomes 0 when:
1. No axis movement distribution pulses are accumulated in the acceleration/deceleration control section.

(4) In-position signal INPX

- [Classification] Input signal <Xx+0#3> (common to both the peripheral equipment control and direct command interfaces)
- [Function] This signal indicates that the controlled axis is in position (has reached the specified value).
- [Input condition] The signal becomes 1 when:
1. There is no acceleration/deceleration delay (accumulated pulses) for the controlled axis, and the servo positional deviation is within a parameter-specified range.
- The signal becomes 0 when:
1. There is an acceleration/deceleration delay (accumulated pulses) for the controlled axis, or
 2. The servo positional deviation falls outside a parameter-specified range.

(5) Servo positional deviation monitor signal SVERX

- [Classification] Input signal <Xx+7#6> (peripheral equipment control interface)
<Xx+3#6> (direct command interface)
- [Function] This signal indicates that, in the servo amplifier module, the amount of servo positional deviation has exceeded a parameter-specified value.
- [Input condition] The signal becomes 1 when:
1. The servo positional deviation amount is larger than a parameter-specified value.
- The signal becomes 0 when:
1. A parameter-specified value for the servo positional deviation amount is 0, or
 2. The servo positional deviation amount is within a parameter-specified range.

(6) Axis movement in-progress signal MVX

- [Classification] Input signal <Xx+7#2> (peripheral equipment control interface)
<Xx+3#2> (direct command interface)
- [Function] The signal indicates that movement along the controlled axis is being performed.
- [Input condition] The signal becomes 1 when:
1. Controlled axis movement begins.
 2. Bit 7 (SVFP) of parameter No. 010 is set to 1 to perform follow-up in clamp processing or servo-off state, and the servo position deviation amount (DGN No. 032) is not zero.

The signal becomes 0 when:

1. Controlled axis movement ends, and the controlled axis enters the in-position state.
2. Bit 7 (SVFP) of parameter No. 010 is set to 1 to perform follow-up in clamp processing or servo-off state, and the servo position deviation amount (DGN No. 032) is zero.

NOTE

The MVX signal is valid while jog feed (JOG) mode is set.

(7) Movement direction signal MVDX

- [Classification] Input signal <Xx+7#0> (peripheral equipment control interface)
<Xx+3#0> (direct command interface)
- [Function] The servo amplifier module indicates the movement direction of its controlled axis.
- [Input condition] The signal becomes 1 when:
1. Controlled axis movement in the negative direction begins.
- The signal becomes 0 when:
1. Controlled axis movement in the positive direction begins.

NOTE

- 1 The MVDX signal is valid while jog feed (JOG) mode is set.
- 2 The MVDX signal maintains its current state during a stop. It does not become 0 even upon a stop after movement in the negative direction.
- 3 The servo amplifier module outputs the MVDX signal even during follow-up, provided the necessary condition is satisfied.

(8) Area signals PSG1 and PSG2

- [Classification] Input signal PSG1<Xx+7#3>, PSG2<Xx+7#4>
(peripheral equipment control interface)
PSG1<Xx+3#3>, PSG2<Xx+3#4>
(direct command interface)
- [Function] The servo amplifier module indicates that the current machine coordinates are within a parameter-specified range, using two code signal outputs.
- [Input condition] If a parameter is set up as shown below, PSG1 and PSG2 are output in the respective sections, as shown below.

(1) to (3) are parameter-set values.

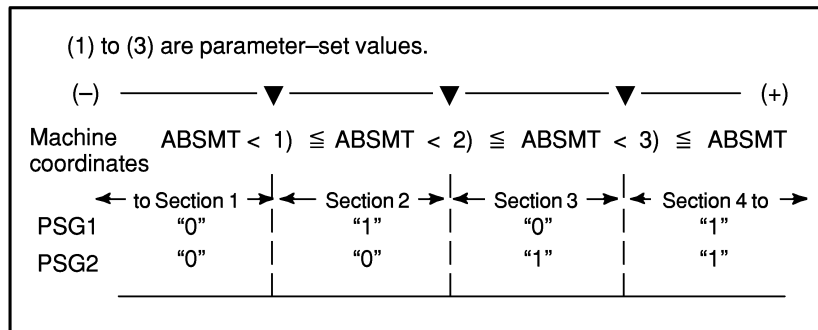
**NOTE**

- 1 The servo amplifier module outputs the PSG1 and PSG2 signals even during follow-up, provided the necessary condition is satisfied.
- 2 When bit 1 (PSSV) of parameter No. 007 is "1", input is accomplished with the position (actual motor position) with consideration given to the acceleration/deceleration, servo positional deviation, etc.

(9) Speed control mode signal TRQM

- [Classification] Input signal <Xx+2#2>
- [Function] The servo amplifier module notifies that the speed control mode is set.
- [Input condition] The signal becomes 1 when:
1. When speed control is activated, and the speed control mode is set
- The signal becomes 0 when:
1. When the speed control stop command is executed
 2. Servo alarm, overtravel alarm, reset, emergency stop, servo-off

(10) Function enable signal OPTENB

- [Classification] Input signal <Xx+1#3> (common to both the peripheral equipment control and direct command interfaces)
- [Function] The servo amplifier module notifies that the function is enabled (usable).
The function is as follows:
- Unexpected disturbance torque detection function (software option function)
- [Input condition] The signal becomes 1 when:
1. The function becomes usable.
- The signal becomes 0 when:
1. The function is under preparation, immediately after power on.
 2. The function is not ordered.

⚠ CAUTION

The Unexpected disturbance torque detection function is disabled until this signal becomes "1". Be sure to confirm that this signal is "1" before starting axis movement.

2.3.7 Feedrate

(1) Override signals *OV1 to *OV8

[Classification] Output signal <Yy+7#0 to #3> (peripheral equipment control interface)
<Yy+2#0 to #3> (direct command interface)

[Function] The host applies override to jog feed and cutting feedrates.

[Operation] Four binary code signals are provided. They correspond to the override values listed below.

*OV8	*OV4	*OV2	*OV1	Override value (%)
1	1	1	1	0
1	1	1	0	10
1	1	0	1	20
1	1	0	0	30
1	0	1	1	40
1	0	1	0	50
1	0	0	1	60
1	0	0	0	70
0	1	1	1	80
0	1	1	0	90
0	1	0	1	100
0	1	0	0	110
0	0	1	1	120
0	0	1	0	130
0	0	0	1	140
0	0	0	0	150

Actual jog feed and automatic cutting feedrates are obtained by multiplying the respective specified values by the override values.

(2) Manual rapid traverse selection signal RT

[Classification] Output signal <Yy+7#7> (peripheral equipment control interface)
<Yy+2#7> (direct command interface)

[Function] The host selects rapid traverse for jog feed.

[Operation] The RT signal is valid when jog feed mode (JOG) is selected. When the signal is 1, jog feed is performed at a rapid traverse rate. Under this condition, setting a feed axis and direction selection signal (+X or -X) to 1 starts rapid traverse in the specified direction. If jog feed is selected, a feed axis and direction selection signal (+X or -X) is 1, and an override signal is valid, setting the RT signal to 1 starts rapid traverse. Resetting the RT signal to 0 resumes normal feed.

(3) Rapid traverse override signals ROV1 and ROV2

[Classification] Output signal <Yy+7#4 to #5> (peripheral equipment control interface)
<Yy+2#4 to #5> (direct command interface)

[Function] The host specifies override for rapid traverse.

[Operation] The following table lists the override amounts.

ROV2	ROV1	Override value
0	0	100%
0	1	50%
1	0	25%
1	1	F0

NOTE

F0 is a value specified in parameter No. 061.

(4) Incremental feed signal MP1, MP2

[Classification] Output signal <Yy+7#4 to #5> (peripheral equipment control interface)

[Function] Used to select the manual handle feed magnification of the servo amplifier module.

[Operation] In manual handle mode, the servo amplifier module drives the motor for the pulses of the input manual pulse generator times the magnification selected with this signal.

MP1	MP2	Amount of travel per graduation of the manual pulse generator
0	0	1 user unit
0	1	10 user units
1	0	100 user units
1	1	(M/N) user unit (M = Parameter No. 62, N = Parameter No. 63)

NOTE

- 1 This signal is effective if bit 5 (MP) of parameter No. 5 of the servo amplifier module is 1.
- 2 This signal is effective in manual handle mode only.
- 3 This signal shares the same bits with the rapid traverse override signal. In manual handle mode, these bits are for the incremental feed signal; in modes other than manual handle mode, they are for the rapid traverse override signal. Before switching from manual handle mode to another mode, this signal must be returned to such a setting that the bits are for the rapid traverse override signal.

2.3.8 Interlock

(1) Interlock signal *ILK

[Classification]	Output signal <Yy+1#3> (common to both the peripheral equipment control and direct command interfaces)
[Function]	The host stops sending all movement commands.
[Input condition]	When the *ILK signal is 0, the host resets all movement command signals to 0 to decelerate and stop controlled axis feed. Movement commands remain valid when the *ILK signal is 0. When it becomes 1, movement is resumed immediately. No command other than a move command is affected.

NOTE

The interlock signal is valid in jog feed mode (JOG).

2.3.9 Reference Position Return

(1) Reference position return completion signal ZPX

[Classification]	Input signal <Xx+2#0> (common to both the peripheral equipment control and direct command interfaces)
[Function]	The servo amplifier module indicates that it is at the reference position.
[Input condition]	The signal becomes 1 when: <ol style="list-style-type: none"> Manual reference position return is completed, and the servo amplifier module enters the in-position state. Function code command-based reference position return is completed, and the servo amplifier module enters the in-position state. The signal becomes 0 when: <ol style="list-style-type: none"> The servo amplifier module moves out of the reference position.

(2) Reference position establishment signal ZRFX

[Classification]	Input signal <Xx+1#2> (common to both the peripheral equipment control and direct command interfaces)
[Function]	The servo amplifier module notifies the host of the reference position establishment state.
[Input condition]	The signal becomes 1 when: <ol style="list-style-type: none"> Reference position establishment is completed. The signal becomes 0 when: <ol style="list-style-type: none"> Reference position establishment is not completed.

NOTE

This signal is effective if bit 2 (ZRNO) of parameter No. 004 is "1".

2.3.10 Automatic Operation

(1) Automatic operation start signal ST

- [Classification] Output signal <Yy+0#7> (common to both the peripheral equipment control and direct command interfaces)
- [Function] The host starts function code commands, such as part of peripheral equipment control ATC operations and point positioning. Specifically, the host issues a direct command to start 32-block buffering.
- [Operation] When the ST signal is set to 1 then reset to 0 again, the servo amplifier module begins operating. Section 3.3.1 explains the function codes for which the ST signal is valid in peripheral equipment control.

NOTE

It is also possible to start operation at the rising edge (from off to on) of the ST signal as specified by the STON parameter (bit 7 of parameter No. 003).

(2) Automatic operation start in-progress signal STL

- [Classification] Input signal <Xx+1#5> (common to both the peripheral equipment control and direct command interfaces)
- [Function] This signal indicates that automatic operation has been started.
- [Input condition] The signal becomes 1 when a command to start automatic operation is issued.
It becomes 0 when automatic operation stops.

(3) Automatic operation signal OP

- [Classification] Input signal <Xx+1#7>(common to both the peripheral equipment control and direct command interfaces)
- [Function] This signal indicates that a series of automatic operations is in progress.
- [Input condition] The signal becomes 1 when a command to start automatic operation is issued. The signal remains set to 1 even after automatic operation stops. It becomes 0 upon the occurrence of a reset.

(4) Dry run signal DRN

- [Classification] Output signal <Yy+7#6>(peripheral equipment control interface)
<Yy+2#6>(direct command interface)
- [Function] Dry run is valid during automatic operation (AUTO mode). During dry run, a feedrate command issued during automatic operation is ignored, and a manual-feed feedrate determined by override signals *OV1 to *OV8 ((1) of Section 2.3.7) is used. Dry run is also valid for rapid traverse. When the RT signal ((2) of Section 2.3.7) is set to 1 during dry run, the "rapid traverse rate" and the "maximum manual-feed feedrate" are used for the rapid traverse and cutting feed blocks, respectively. When the RT signal is reset to 0, the "same rate as the manual-feed feedrate" is resumed.
- [Operation] Setting the DRN signal to 1 causes the system to enter the dry run state. Resetting it to 0 resumes the feed rate specified during automatic operation.

2.3.11 Clamp and Unclamp (for the Peripheral Equipment Control Interface Only)

NOTE

When the signal described below is used, the external pulse input function cannot be used.

(1) Unclamp command signal UCPC2

[Classification]	Input signal <Xx+1#4>
[Function]	An actual machine clamp/unclamp operation is performed by the host. The servo amplifier module outputs this signal when a function code command for peripheral equipment control is executed, thereby requesting a clamp/unclamp operation to the host.
[Input condition]	The signal becomes 1 when: The module requests an unclmap operation to the host. The signal becomes 0 when: The module requests a clamp operation to the host. The servo amplifier module sets UCPC2 to "1" when a move command with a function code starts. The module sets it to "0" at the end of the move command. For details, see the timing chart of each function code for peripheral equipment control.

NOTE

The UCPC2 signal is valid when the NCLP parameter (bit 1 of parameter No. 003) is 0.

(2) Clamp/unclamp state output signal UCPS2

[Classification]	Output signal <Yy+0#6>
[Function]	When the servo amplifier module requests clamping/unclamping of the machine, using the UCPC2 signal, the host actually clamps/unclamps the machine. Upon the completion of clamping/unclamping, it reports it to the servo amplifier unit, which then proceeds to the next processing.
[Operation]	The signal is set to 1 when the machine is unclamped. When it is clamped, the signal is reset to 0. See the timing chart for the function codes for peripheral equipment control.

NOTE

The UCPS2 signal is valid when the NCLP parameter (bit 1 of parameter No. 003) is 0.

2.3.12 Servo-off

(1) Servo-off command signal SVFX

[Classification] Output signal <Y_{y+1}#2> (common to both the peripheral equipment control and direct command interfaces)

[Function] The host turns off the servo circuit for a controlled axis, that is, shuts off the current to the servo motor of the controlled axis. This disables positioning control. Position detection continues, however. So, the current position will not be lost.

[Operation] The servo motor remains off while the signal is 1. If the machine is moved by the application of external force, its coordinates are shifted, because positioning control does not work during the servo-off state. How the shifted machine coordinates are handled can be selected by a parameter, as follows:

1. The machine coordinate shift is recorded in an error counter.
When the servo-off signal becomes 0, the machine moves to cancel out the error recorded in the error counter.
2. Follow-up is performed.
The machine coordinate shift is regarded as being the result of a command, and the control unit adjusts its current position data so that the error counter becomes 0. With this method, the machine remains in a shifted position even after the servo-off signal becomes 0. However, the machine moves to the correct position the next time an absolute command is issued, because the control unit has information about the correct position.

[Use] Generally, method 1 above is used to prevent excessive current flowing through the servo motor when it is clamped mechanically with a force stronger than the servo motor can generate. Usually, the host keeps the interlock signal at 0 while the servo-off signal is 1. Generally, method 2 is used to operate the machine by rotating the motor with a handle feed mechanism.

2.3.13 Peripheral Equipment Control Function Code and Related Information

(1) Operation completion signals OPC1, OPC2, OPC3, and OPC4

[Classification]	Input signal <Xx+0#4 to #7>
[Function]	The servo amplifier module indicates information about the completion of each function code. The host executes its sequence according to this signal.
[Input condition]	See the timing chart of each function code for the corresponding input timing. OPC1 indicates, to the host, that the servo amplifier module has received a command. The servo amplifier module issues an unclamp command signal (UCPC2 = 1) to request the host to unclamp the machine. OPC2 indicates, to the host, that the servo amplifier module has received an unclamp completed command signal (UCPS2 = 1). The servo amplifier module starts axis operation. OPC3 indicates, to the host, that an axis operation is completed and the in-position state is assumed, simultaneously as the clamp command (UCPC2 = 0). OPC4 indicates, to the host, that the servo amplifier module has received the clamp completion signal (UCPS2 = 0) and finished executing all commands. The timing at which the signal is input is set in parameter No. 166.

CAUTION

If the unclamp command signal (UCPC2) and the clamp/unclamp state output signal (UCPS2) are not used (bit 1 (NCLP) of parameter No. 003 = 1), OPC4 is output to the host even if the instruction command is interrupted due to an external reset, emergency stop, alarm, etc.

NOTE

When the unclamp command signal (UCPC2) and clamp/unclamp state output signal (UCPS2) are not used (when bit 1 (NCLP) of parameter No. 003 = 1), OPC2 and OPC3 are not output to the host. In this case, OPC4 is output to the host when an axis operation is completed and the in-position state is assumed.

(2) Function code

[Classification]	Output signal <Yy+2#4 to #7>
[Function]	The host sets the peripheral equipment control function code.
[Output condition]	See the timing chart of each function code for the corresponding output timing. See Sections 3.3 and 3.4 for details.

(3) Command data 1

[Classification]	Output signal <Yy+2#0 to #3>
[Function]	The host sets command data 1 to specify the feed rate for peripheral equipment control.
[Output condition]	See the timing chart of each function code for the corresponding output timing. See Sections 3.3 and 3.4 for details.

(4) Command data 2

[Classification]	Output signal <Yy+3 to Yy+6>
[Function]	The host sets command data 2 to specify the amount of movement for peripheral equipment control.
[Output condition]	See the timing chart of each function code for the corresponding output timing. See Sections 3.3 and 3.4 for details.

(5) Response data

[Classification]	Input signal <Xx+3 to Xx+6>
[Function]	<p>(A) The servo amplifier module outputs the current position number (point, turret, or magazine number) for point or ATC control. This response data is set up upon the completion of positioning. The servo amplifier module continues to output the previous number until the new response data is set up.</p> <p>(B) By setting parameter No. 020 appropriately, it is possible to output the following data items real-time:</p> <ul style="list-style-type: none"> • Machine coordinates • Workpiece coordinates • Motor current value • Skip measurement data • Actual feedrate • Actual rotation speed • Torque command

NOTE

Skip measurement data is output when the skip signal is input or when the end point is reached.

[Input condition]	<p>(C) When the DSAL signal [Subsection 2.3.13.(9)] is 1, the servo amplifier module outputs the number of alarms and the first alarm number.</p> <p>See the function code command list for details.</p>
-------------------	--

⚠ CAUTION

- 1 The purpose of this data, when used by the host, is limited to display on the host. This data consists of 32 bits of DI signals; the bits are not updated at a time, but are updated on a bit-by-bit basis. So, if this data is being updated when coordinates are read during movement on axes, the correct position may not be read normally. This data is prepared for position display on the host, so that this data cannot be used to make a machine area check. However, correct coordinates can be read even during movement on axes by establishing synchronization between the host and servo amplifier module. For details, see Section 3.8. This is true of all data items output real-time.
- 2 The current position number (point, turret, and magazine number) is not output until the reference position is established. If bit 2 (NZRPO) of parameter No. 007 is "1", it is output even if the reference position is not established.
- 3 The current position number (point, turret, and magazine number) is 0 when the power is turned on, and is output upon the completion of positioning due to peripheral equipment control ATC operations, point positioning, or reference position return. If, then, a move command such as JOG operation is executed, the current position number no longer matches the current position on the axes. If, after the completion of ATC operations, point positioning, or reference position return, a move command such as jog operation is started, it is no longer possible to control the current position on the axes by looking at the current position number output on the host. Besides, if, after an index command of ATC operations is started, it is interrupted due to the occurrence of a reset, alarm, etc., the current position number no longer matches the current position on the axes.
As for the turret/magazine number, however, the constraint described above is eliminated and the correct number can be constantly output because of improved specifications. For details, see Section 3.9, "Turret/Magazine Number Output Improvement".

(6) Response data check signals DSP1 and DSP2

- [Classification] Input signal <Xx+2#4 to #5>
 [Function] The servo amplifier module indicates the contents of the response data.
 [Input condition] The servo amplifier module specifies the response data using a combination of signals, as listed below.

DSP2	DSP1	Response data
0	0	Not output
1	1	Coordinates, motor current value, skip measurement data, or torque command
1	0	Current position number (ATC, point number)
0	1	Actual feedrate or actual speed

NOTE

- 1 The setting of parameter No. 20 determines which of coordinates, motor current value, skip measurement data, and torque command the response data is.
- 2 The setting of parameter No. 20 determines which of actual feedrate and actual speed the response data is.

(7) Response data write completion signal ABSWT

- [Classification] Input signal <Xx+1#0>
 [Function] After writing response data (Xx+3 to Xx+6), the servo amplifier module inverts this signal for notification to the host.
 [Operation] The servo amplifier module exclusive-ORs ABSWT with ABSRD. When the result of exclusive-OR is 0, response data (Xx+3 to Xx+6) is written, and this signal is inverted.

(8) Response data read completion signal ABSRD

- [Classification] Output signal <Yy+1#4>
 [Function] After reading response data (Xx+3 to Xx+6), the host inverts this signal for notification to the servo amplifier module.
 [Operation] The host exclusive-ORs ABSWT with ABSRD. When the result of exclusive-OR is 1, response data (Xx+3 to Xx+6) is read, and this signal is inverted.

(9) Alarm output command signal DSAL

- [Classification] Output signal <Yy+0#3>
 [Function] The host specifies that alarm information be output as response data. When DSAL is 1, the following information is output as response data.

Xx+3	Number of alarms (byte type)
Xx+4,Xx+5	Alarm number (word type)

- [Operation] When the signal is 0, a turret, magazine, point number, coordinates, or motor current value are output as response data. When the signal is 1, the number of alarms and the first alarm number are output as response data.

(10) Alarm output state check signal DSALO

[Classification]	Input signal <Xx+2#3>
[Function]	The servo amplifier module indicates the contents of the response data.
[Input condition]	When the signal is 0, a turret, magazine, point number, coordinates, or motor current value are being output as response data. When the signal is 1, the number of alarms and the first alarm number are being output as response data.

2.3.14 Direct Command Function Code and Related Information**(1) Function code command strobe signal EBUF**

[Classification]	Output signal <Yy+4#7>
[Function]	After setting the function code (Yy+5) and command data (Yy+6 to Yy+15), the host inverts the logical state of this signal to indicate to the servo amplifier module that the function code is ready for transfer.
[Operation]	The servo amplifier module exclusive-ORs EBUF with EBSY. If the result of exclusive ORing is 1, the servo amplifier module behaves as follows: <ul style="list-style-type: none"> (A) When the function code command is of a type to be buffered before execution. <ol style="list-style-type: none"> 1. If the function code command buffer of the servo amplifier module is available, the servo amplifier module receives the function code command at the function code command buffer. 2. If the function code command buffer of the servo amplifier module is unavailable, the servo amplifier module waits until it becomes available, that is, rejects reception of the current function code command. (B) If the function code command is of a type to be executed immediately without being buffered <ol style="list-style-type: none"> 1. The servo amplifier module receives the function code command at its execution buffer immediately and starts processing according to the function code command.

(2) Function code command read completion signal EBSY

[Classification]	Input signal <Xx+4#7>
[Function]	The servo amplifier module indicates that it has accepted a function code command. Because the result of exclusive-ORing EBUF and EBSY becomes 0, it becomes possible to issue another function code.
[Input condition]	The state of the signal is inverted when a function code command is received by the servo amplifier module.

(3) Function code

[Classification]	Output signal <Yy+5>
[Function]	The host specifies the function code command to be executed.
[Operation]	The servo amplifier module behaves as directed by the function code command when receiving it. See "Direct command function details" for details.

(4) Command data

[Classification]	Output signal <Yy+6 to Yy+15>
[Function]	The host provides data for a function code command.
[Operation]	The servo amplifier module behaves as directed by the function code command when receiving it. See "Direct command function details" for details.

(5) Response data

[Classification]	Input signal <Xx+7 to Xx+15>
[Function]	(A) The servo amplifier module returns the result of function code command execution. (B) The servo amplifier module returns the data requested by the function code. (C) The servo amplifier module outputs continuous-output data, such as the current position, requested by the continuous read command.
[Input condition]	(A) The servo amplifier module returns the result of function code command execution. It is possible to defer the return of the result of each function code command and return their results at the same time, if they are of a type that can be buffered. (B) The servo amplifier module outputs data, such as alarm information, requested by the function code. (C) If the host is to receive data, such as the current position, that is being monitored continuously, the servo amplifier module continues to output the requested data in response to a single request. After setting the above data or result, the servo amplifier module inverts the state of EOSTB. They can be read when the result of exclusive-ORing EOREND with EOSTB is 1. EOPC indicates that the current data is of continuous output type. When EOPC is 0, it indicates data covered in (A) or (B). When it is 1, it indicates data covered in (C).

(6) Continuously output data signal EOPC

[Classification]	Input signal <Xx+4#2>
[Function]	The servo amplifier module indicates that continuously output data requested using a function code command is being output as response data.
[Input condition]	The signal becomes 1 when: <ol style="list-style-type: none"> Continuously output data requested by a function code command is being output as response data. The signal becomes 0 when: <ol style="list-style-type: none"> Data other than continuously output data requested by a function code command is being output as response data.

(7) Response data readable signal EOSTB

- [Classification] Input signal <Xx+4#6>
 [Function] The servo amplifier module indicates that data requested using a function code command has been output as response data and is now readable.
 [Input condition] The state of the signal is inverted when:
1. The response data becomes readable.

(8) Response data read completion signal EOREND

- [Classification] Output signal <Yy+4#6>
 [Function] The host notifies the servo amplifier module that it has read response data.
 [Operation] When the state of the signal is inverted, the servo amplifier module behaves as follows:
1. The result of function code command execution is output as response data.
 2. If a function code command is a data output command, the command is executed, and the result is output as response data.

NOTE

If the result of exclusive-ORing EOSTB with EOREND is 1, it becomes impossible to output further command data. Before inverting the state of EOREND, apply appropriate countermeasures.

(9) Command continuation notification signal ECNT

- [Classification] Output signal <Yy+4#0>
 [Function] When the host has too much command data to be sent at one time, it sets the ECNT signal to 1 to inform the slave that remaining data exists.
 [Operation] When the ECNT signal becomes 1, the servo amplifier module behaves as follows:
1. After receiving command data from the buffer, the servo amplifier module inverts the state of the EBSY signal so that it matches the state of the EBUF, thereby prompting the transfer of the next data. The signal is reset to 0 at the last data of a series of commands.

(10) PMM data signal USR1

- [Classification] Input signal <Xx+4#3>
 [Function] Direct commands transfer data using the same area as the power mate CNC manager function. If USR1 is 0, it is necessary to perform special processing to read the data, because it is a response from the ladder program of the host. If USR1 is 1, the response command (Xx+4 and after) is for the power mate CNC manager and, therefore, the ladder program on the host ignores it.
 [Input condition] The signal becomes 1 when:
1. The response data is power mate CNC data.
- The signal becomes 0 when:
1. The response data is data from a ladder program.

(11) Response data continuation notification signal ECONT

- [Classification] Input signal <Xx+4#0>
- [Function] If there is too much response data to be sent at one time, the ECONT signal is set to 1. In this case, after reading the current data, the host waits for the next data. The host must continue to read data for as long as the ECONT signal is 1. The "next data" is input from Xx+5.
- [Input condition] The signal becomes 1 when:
1. Remaining response data exists.
- The signal becomes 0 when:
1. All response data has been read.

(12) Function code command completion notification signal ECF

- [Classification] Input signal <Xx+4#5>
- [Function] If function code command execution completion notification mode is entered with NMOD set to 1, the servo amplifier module sets ECF to 1 to indicate that positioning directed by this command has been completed, and waits for the next command to be executed until the host responds. The host issues the SET FIN command to cause processing to move to the next command.
- [Input condition] The signal becomes 1 when:
1. The system enters function code command execution completion notification mode with NMOD set to 1, and positioning directed by the function code is completed.
- The signal becomes 0 when:
1. The SET FIN command is executed.

(13) Alarm signal DAL

- [Classification] Input signal <Xx+4#1>
- [Function] If an alarm condition occurs in the servo amplifier module, the servo amplifier module sets the DAL signal to 1. The host issues a READ ALARM STATUS command to read details of the alarm condition, as required.
- [Input condition] The signal becomes 1 when:
1. When an alarm condition occurs in the slave.
- The signal becomes 0 when:
1. When there is no alarm condition in the slave.

(14) Wait signal WAT

- [Classification] Input signal <Xx+1#0>
- [Function] The servo amplifier module indicates, to the host, that it is in the wait state. After performing the necessary processing, the host returns a wait completion signal (WFN) to cause the servo amplifier module to continue operating. This method is used by the servo amplifier module to request the host to perform processing, when the servo amplifier module is running continuously in memory operation mode.
- [Input condition] The signal becomes 1 when:
1. The servo amplifier module executes a wait command during memory operation.
- The signal becomes 0 when:
1. The host sets the wait completion signal WFN to 1.

(15) Wait completion signal WFN

- [Classification] Output signal <Yy+1#4>
- [Function] If the servo amplifier module issues wait signal WAT to cause it to enter the wait state, the host releases the servo amplifier module from the wait state. Upon receiving the wait completion signal, the servo amplifier module executes the next command.
- [Operation] When the servo amplifier module is in the wait state, it sets the wait signal WAT to 1. If the WFN signal is set to 1 under this condition, the servo amplifier unit and host behave as follows:
1. The servo amplifier module resets the wait signal WAT to 0. Upon detecting that the WAT becomes 0, the host resets the WFN to 0. The servo amplifier module exits from the wait state and executes the next command.

(16) Memory registration signal INPF

- [Classification] Output signal <Yy+3#7>
- [Function] The host can store function code commands into the memory of the servo amplifier unit and control memory operation according to the data in the memory. If buffering type function code, such as a position command, is issued with INPF set to 1, it is registered into memory instead of being executed. Up to 32 blocks can be registered. Once a series of registration operations has been completed, the INPF is reset to 0. This command is erased when the power is switched off. It is necessary to register it in memory before memory operation is used. If the INPF is set to 1 when function code is already registered in memory, the function code is cleared from memory, allowing new function code to be registered.
- [Operation] If buffering type function code is issued with INPF set to 1, it is stored into memory instead of being executed.

(17) Memory registration in-progress signal INPFO

- [Classification] Input signal <Xx+3#7>
- [Function] The servo amplifier module indicates, to the host, that it is in memory registration mode. When the INPFO signal is 1, a buffering type function code command, such as a positioning command, is stored into memory instead of being executed.
- [Input condition] The signal becomes 1 when:
1. The host sets the INPF signal to 1 to specify memory registration mode, and the servo amplifier module enters memory registration mode.
- The signal becomes 0 when:
1. The host resets the INPF signal to 0 to release memory registration mode, and the servo amplifier module exits from memory registration mode.

(18) Interface switch signal DRC

[Classification]	Output signal <Yy+1#5>
[Function]	The host informs the servo amplifier module of the interface type (peripheral equipment control interface or direct command interface) to be used.
[Operation]	When the DRC signal is 0, the slave runs using the peripheral equipment control interface. When it is 1, the slave runs using the direct command interface. The servo amplifier module also sends the interface status notification signal DRCO ((19) of Section 2.3.14) to the host. After detecting the DRCO signal, the host issues commands. After changing the DRC signal, the host should not issue a command within one scan after the DRCO signal changes. Once the state of the DRC signal is inverted, do not invert it again before the state of the DRCO signal changes accordingly, as data communication with the servo amplifier module is hindered. Before inverting the state of the DRC signal again, wait for at least one scan after the state of the DRCO signal changes.

NOTE

Usually, the DRC signal should not be switched while the power is switched on. If necessary, it should be switched during a reset state, that is, while neither automatic nor JOG operation is in progress. Moreover, it should not be switched when the motor is not in the in-position state.

(19) Interface status notification signal DRCO

[Classification]	Input signal <Xx+1#1>
[Function]	The servo amplifier module informs the host of the current interface mode (peripheral equipment control or direct command interface). After detecting the DRCO signal, the host issues commands.
[Input condition]	The signal becomes 1 when: <ol style="list-style-type: none"> 1. The slave is in direct command interface mode. The signal becomes 0 when: <ol style="list-style-type: none"> 1. The slave is in peripheral equipment control interface mode.

2.3.15 Direct Input Signals

NOTE

The following signals are not host-to-servo amplifier module FANUC I/O Link interface signals.

(1) Emergency stop signal *ESP

[Classification]	Servo amplifier module direct input signal
[Function]	The host stops the servo amplifier module immediately.
[Operation]	When the signal becomes 0, the servo amplifier module behaves as follows: <ol style="list-style-type: none"> 1. Hosts stops servo amplifier module immediately. 2. A reset is performed after a stop. 3. The servo system cannot operate for as long as the emergency stop signal is 0. So, the servo preparation completion signal SA is held at 0. If the machine is shifted while the SA is 0, the shift is reflected in the current coordinates in the servo amplifier module; the current position will not be lost (follow-up). 4. Neither jog feed nor a function code command can be issued while the emergency stop signal is 0.

(2) Overtravel signals *-OT and *+OT

[Classification]	Servo amplifier module direct input signal
[Function]	The host indicates that the controlled axis has reached the stroke limit described below. *-OT: The stroke limit in the negative direction has been reached. *+OT: The stroke limit in the positive direction has been reached.
[Operation]	When the signal becomes 0, the servo amplifier module behaves as follows: <ol style="list-style-type: none"> 1. The controlled axis is stopped immediately by zero-speed-based deceleration, and an OT alarm for the input direction is output. A movement in the opposite direction can be made by jog feed or handle feed. The execution of function code commands and the reading of commands are stopped. 2. The direction in which the signal becomes 0 is memorized. Even after the signal is returned to 1, the controlled axis is prevented from operating in that direction until the OT alarm is reset.

(3) High-speed interlock signal *RILK

[Classification]	Servo amplifier module direct input signal
[Function]	The host stops all movement command-specified feed.
[Operation]	While the signal is 0, the servo amplifier module resets the all movement command-specified feed to 0 to stop controlled axis feed. Axis movement is decelerated to a stop. A move command remains valid even when the signal is 0. Movement can be resumed immediately when the signal is set to 1 again. This does not affect non-move commands.

(4) Deceleration signal for reference position return *DEC

- [Classification] Servo amplifier module direct input signal
- [Function] The host decelerates feed operation based on a reference position return command.
- [Operation] The servo amplifier module decelerates feed for reference position return when this signal switches from 1 to 0. After deceleration, the FL feedrate (set in parameter No. 054) is used for movement. If this signal switches from 0 to 1 during movement at the FL feedrate, the movement being made along an axis stops at the first encountered grid, and that position becomes a reference position. At this time, the reference position return completion signal (ZPX) is set to 1. For details, see Section 3.5.

NOTE

When the signal described above is used, the high-speed interlock signal (*RILK) cannot be used.

(5) Skip signal HDI

- [Classification] Servo amplifier module direct input signal
- [Function] The workpiece coordinates at the point when this signal is input are recorded.
- [Operation] If, during the execution of the peripheral equipment control command (function code 8) for positioning for the skip function, a rise ("0" to "1") or "1" to "0") of this signal is captured, axis movement is stopped immediately and command execution is terminated. Also, the workpiece coordinates (skip measurement data) at the point when this signal is input are recorded. The recorded data can be read as response data by setting parameter No. 020 to "5".
- Also, while the direct command for positioning for the skip function is being executed independently (the SKIP bit of the absolute positioning command and the incremental positioning command is set), axis movement is stopped immediately and command execution is terminated. If thirty-two-block buffering operation is in progress, the system skips the currently executed block, moving to the next block. Skip measurement data is also recorded during the execution of the direct command. The recorded data can be read on the host by executing the direct command for "reading skip measurement data".

NOTE

- 1 To perform positioning for the skip function, bit 0 (HENB) of parameter No. 017 must be set to "1" (use the skip function).
- 2 It is possible to specify, using an appropriate parameter, whether to retain the previous skip measurement data or record the specified end point coordinates if, during the execution of positioning for the skip function (peripheral equipment control/direct command), the skip signal (HDI) is not input and the end point is reached. If bit 2 (SPCO) of parameter No. 17 is "0", the previous skip measurement data is recorded; if "1", the specified end point coordinates.
- 3 If reading skip measurement data with peripheral equipment control, confirm the completion of positioning for the skip function (OPC4 = 1) beforehand.
- 4 If, during the execution of positioning for the skip function (peripheral equipment control/direct command), the execution is interrupted due to an external reset, emergency stop, alarm, etc., no skip measurement data is updated.

3

PERIPHERAL EQUIPMENT CONTROL

3.1 COMMAND FORMAT FOR PERIPHERAL EQUIPMENT CONTROL

The servo amplifier module receives a command, issued in the specified format, from the host, then executes a sequence of operations for performing peripheral equipment control. When a command for reading the current position is specified, the servo amplifier module returns the result of command execution to the host. The command and result are exchanged, in an interface area, in the formats shown below.

- General format of instruction commands (host → servo amplifier module)

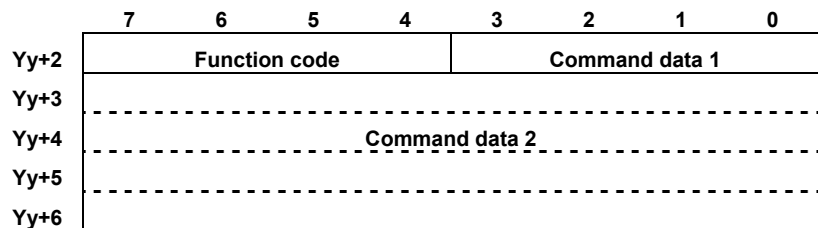

- General format of response commands (servo amplifier module → host)

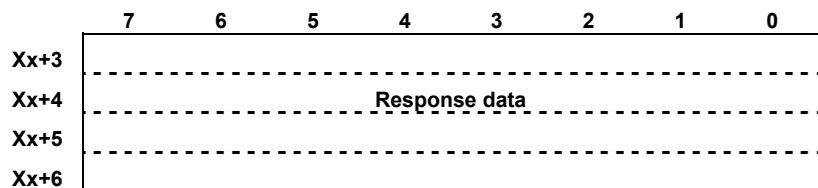

- Data types

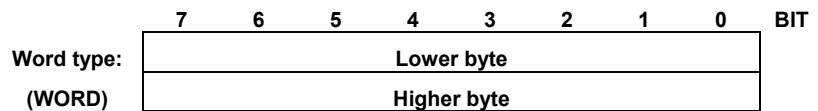
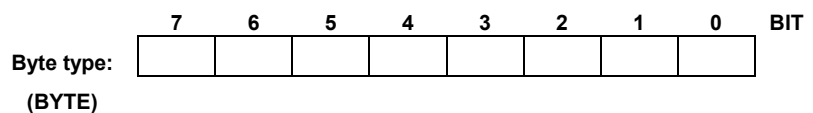

$$\text{Data} = (\text{higher byte}) * 256 + (\text{lower byte})$$

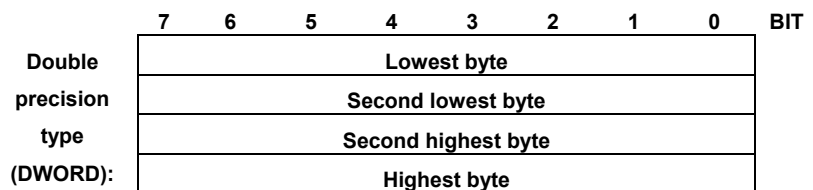

$$\begin{aligned} \text{Data} = & (\text{highest byte}) * 16777216 \\ & + (\text{second highest byte}) * 65536 \\ & + (\text{second lowest byte}) * 256 \\ & + (\text{lowest byte}) \end{aligned}$$

3.2 PERIPHERAL EQUIPMENT CONTROL PROCEDURE

3.2.1 Specifying Operation Using a Function Code

In peripheral equipment control, the host sets a function code, command data 1, and command data 2, then turns the automatic operation start signal (ST) in the interface area on then off to start the instruction command. Some instruction commands use a feed axis and direction select signal (+X or -X).

The servo amplifier module returns a operation completion signal (OPC1, OPC2, OPC3, OPC4) according to the status of command execution; the host performs the corresponding processing.

OPC1 : This signal notifies the host that a function code has been received. At the same time, the unclamp command is output.

OPC2 : This signal notifies the host that the unclamp state output signal has been received.

OPC3 : This signal notifies the host that a movement has been completed. At the same time, the clamp command is output.

OPC4 : This signal notifies the host that the clamp state output signal has been received, and that a function code has been executed. Response data, if any, is set at the same time.

Until OPC4 is received, the next instruction command must not be set.

NOTE

When the clamp/unclamp function is not used, OPC2 and OPC3 are not output from the servo amplifier module.

3.2.2 Receiving Response Data

From the response data, the host can read the current position of the axis controlled by a servo amplifier module as well as any alarm information.

To read alarm information, the host sets the alarm output command signal (DSAL) to 1. When the alarm output state check signal (DSALO) is 1, the number of alarms and alarm numbers are returned as response data.

When the alarm output command signal (DSAL) is set to 0, position information is set as response data. Position data can be selected using parameter No. 20 (PHOUT). The type of data can be checked using a response data check signal (DSP1, DSP2).

3.3 FUNCTION CODES

3.3.1 Function Codes

Function code	Command data 1 4 bits	Command data 2 4 bytes	Mode	Start signal	Remarks
0 : Jog operation			JOG	+X/-X	(Note 1)
2 : ATC operation/turret control	1: Automatic operation (shortcut rotation) 2: Automatic operation (positive direction) 3: Automatic operation (negative direction)	Turret/magazine number	AUTO	ST	Set an amount of travel per ATC rotation and the number of turrets/magazines in the parameters. (Note 3, Note 4, Note 8)
	4 : 1-pitch rotation 5 : Continuous indexing (Note 2)		JOG	+X/-X	
3 : Point positioning	Feedrate code 1 to 7 15: Rapid traverse	Point number 1 to 12	AUTO	ST	(Note 5, Note 6, Note 7, Note 8)
4 : Reference position return	Reference position number 1: First reference position 2: Second reference position 3: Third reference position		JOG	ST	
	15: Reference position setting (Note 9, Note 10)			+X/-X	
	15: Reference position external setting (Note 11)			ST	
5 : Positioning (absolute specification)	Feedrate code 1 to 7 15: Rapid traverse	Workpiece coordinates	AUTO	ST	(Note 6)
6 : Positioning (incremental specification)	Feedrate code 1 to 7 15: Rapid traverse	Travel distance	AUTO	ST	(Note 6)
7 : Speed control	0: Start-up or change-gear command 1: Stop command	Speed command value	AUTO	ST	(Note 12)
8 : Positioning (for skip function)	BIT3: 0(absolute specification) BIT0-2: Feedrate code 1 to 7	Workpiece coordinates	AUTO	ST	(Note 6, Note 13, Note 14)
	BIT3: 0(incremental specification) BIT0-2: Feedrate code 1 to 7	Travel distance			
10: Coordinate system setting	1: Coordinate system setting 2: Magazine number setting 3: Point number setting	Coordinates Magazine number Point number	AUTO	ST	The coordinates corresponding to a number represent the current position.
12 : Parameter rewriting	Parameter type 1: Byte 2: Word 3: Two-word (1st) 4: Two-word (2nd)	Parameter number and parameter value		ST	
14 : Point data external setting	Point number 1 to 12	Point data	JOG	ST	Data is entered into the parameter corresponding to a point number.
15 : Data setting by teaching		Point number 1 to 12	JOG	ST	A coordinate is entered into the parameter corresponding to a point number.

NOTE

- 1 Besides function code 0, jog operation can also be performed with 1, 10, and 15.
- 2 If the remaining distance to the next point is shorter than the required deceleration distance for stopping at that point when the feed axis and direction selection switch (+X, -X) is released, movement is made to the point immediately after the next point.
- 3 Set bit 1 (ROTX) of parameter No. 000 (for rotation axis setting) to 1, and set bit 7 (ROAX) of parameter No. 000 to 1 (for rollover).
- 4 In ATC automatic operation mode, rapid traverse (parameter No. 040) is assumed unconditionally. In jog operation mode, rapid traverse is assumed if the RT signal is ON (parameter No. 040) and jog speed is assumed if the RT signal is OFF (parameter No. 041).
- 5 As the position corresponding to each point number, workpiece coordinates are set in parameter Nos. 154 to 165.
- 6 The feedrates of feedrate codes 1 to 7 are set in parameter Nos. 044 to 050, and a rapid traverse rate is set in parameter No. 040.
- 7 In rollover setting, shortcut control is possible. In rollover setting, set a value within ± 1 rotation for the absolute positioning command.
- 8 When a half rotation command is issued with ATC or point positioning, operation is in the + direction if end point > start point and in the - direction if end point < start point.
- 9 After the power is turned on, performing reference position setting causes 1 to be output as the turret/magazine number. If performing the reference position return function without dogs, be sure to use jog operation to move the tool at a certain speed or greater and for a certain distance or greater (speed and distance enough to accumulate 128 pulses or more of servo positional deviation) in the reference position return direction set in the parameter. After reference position return, by setting bit 1 (SZRN) of parameter No. 011 appropriately, the reference position can be shifted by one grid each time +X/-X is turned ON.
- 10 When bit 2 (DZRN) of parameter No. 011 is set to 1, the reference position return function with dogs is enabled. For details, see Section 3.5, "Reference Position Return Function with Dogs".
- 11 When the absolute pulse coder is used, the current position can be set as the reference position. After positioning to the reference position, perform the reference position external setting function.
- 12 Speed control cannot use clamping/unclamping.
- 13 To perform positioning for the skip function, bit 0 (HENB) of parameter No. 017 must be set to "1" (use the skip function).
- 14 With positioning for the skip function, the command can be interrupted (skipped) during positioning at the time when the skip signal (HDI) is input. Rapid traverse cannot be specified as the positioning speed.
- 15 Never change the current mode during operation. The mode can be changed only after operation has been stopped.
- 16 Axis movement commands other than JOG operation are not executed if the alarm signal (AL) is "1".

3.4 DETAILS OF FUNCTION CODES

3.4.1 ATC/Turret Control

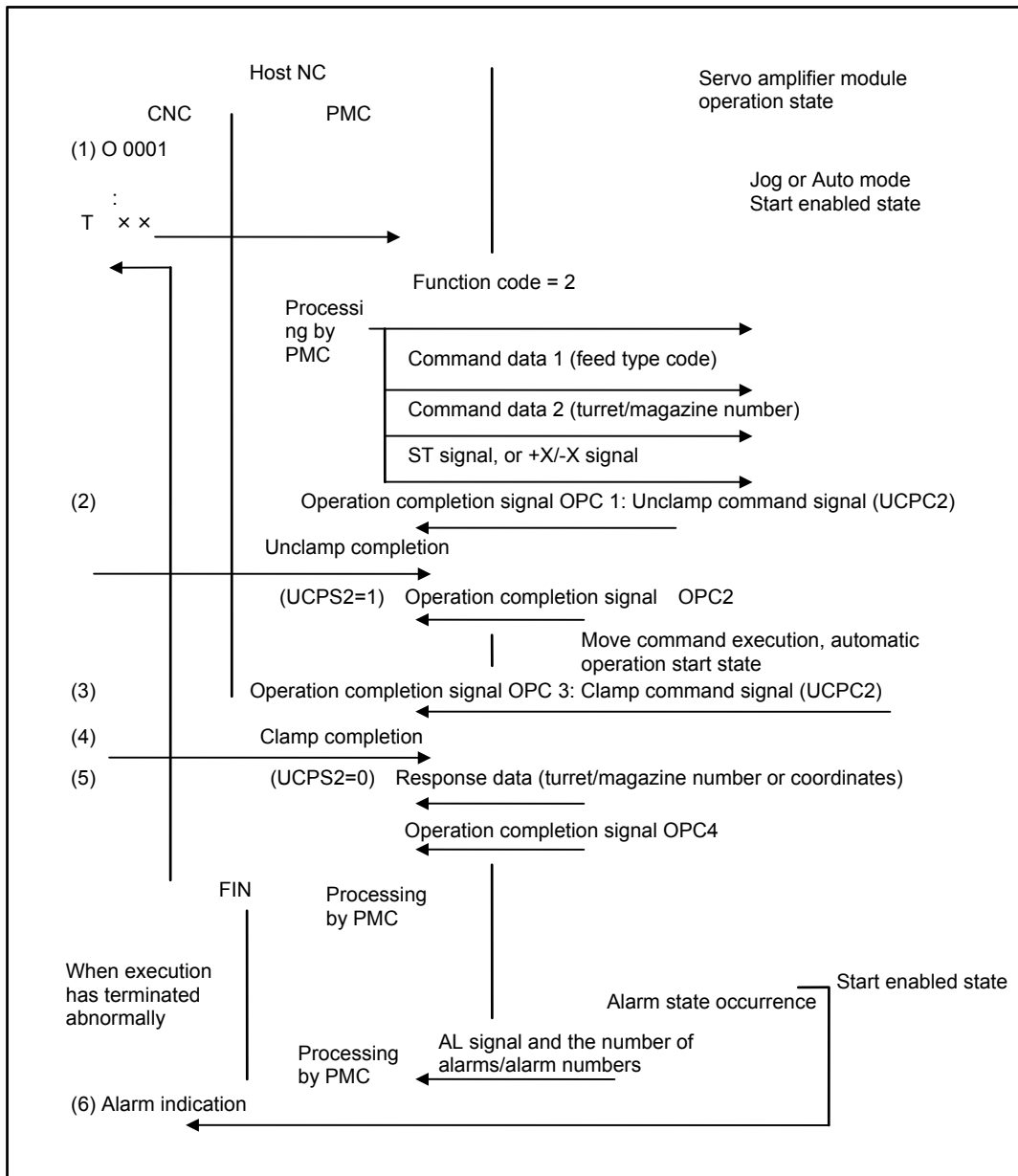

- (1) When the host NC program executes a T code command, the PMC on the host NC sets the function code, command data 1, and command data 2, then sends the ST signal or +X/-X signal to the servo amplifier module. Upon receipt of the data, the servo amplifier module returns the operation completion signal OPC 1 to the host NC, and also outputs the unclamp command signal.
- (2) When unclamp completion notification is sent from the host NC, the servo amplifier unit returns the operation completion signal OPC 2 to the host NC, then starts movement to the position corresponding to a specified turret/magazine number.

- (3) Upon completion of the movement, the servo amplifier module returns the operation completion signal OPC 3 to the host NC, and also outputs the clamp command signal.
- (4) When clamp completion notification is sent from the host NC, the servo amplifier unit returns response data (turret/magazine number or coordinates) and the operation completion signal OPC 4, and is placed in the start enabled state.
- (5) Upon receipt of the operation completion signal OPC 4, the PMC on the host NC returns the FIN signal.
- (6) If an alarm is issued while the servo amplifier module is executing an instruction, the AL signal is output. So, the PMC on the host NC is to perform processing such as alarm indication. In this case, the number of alarms and alarm numbers can be included in the response data by setting the DSAL signal [Subsection 2.3.13.(9)] to 1.

Supplementary information

- 1) The unclamp/clamp command signal and state signal are used for communication with the host.
- 2) Whether the unclamp/clamp state signal is to be checked is specified by setting bit 2 (IGCP) of parameter No. 003. When IGCP is set such that no check is to be made, the operation completion signal OPC 2 and operation completion signal OPC 3 are not output.
- 3) Use parameter No. 167 to set the period between the servo amplifier module being turned on and the output of the unclamp command signal. Use parameter No. 168 to set the period between the clamp command signal being output and the servo amplifier unit being turned off.
- 4) The ST signal can be accepted in the start enabled state only.
- 5) The start enabled state is that state in which the STL signal is off.

3.4.2 Point Positioning Control

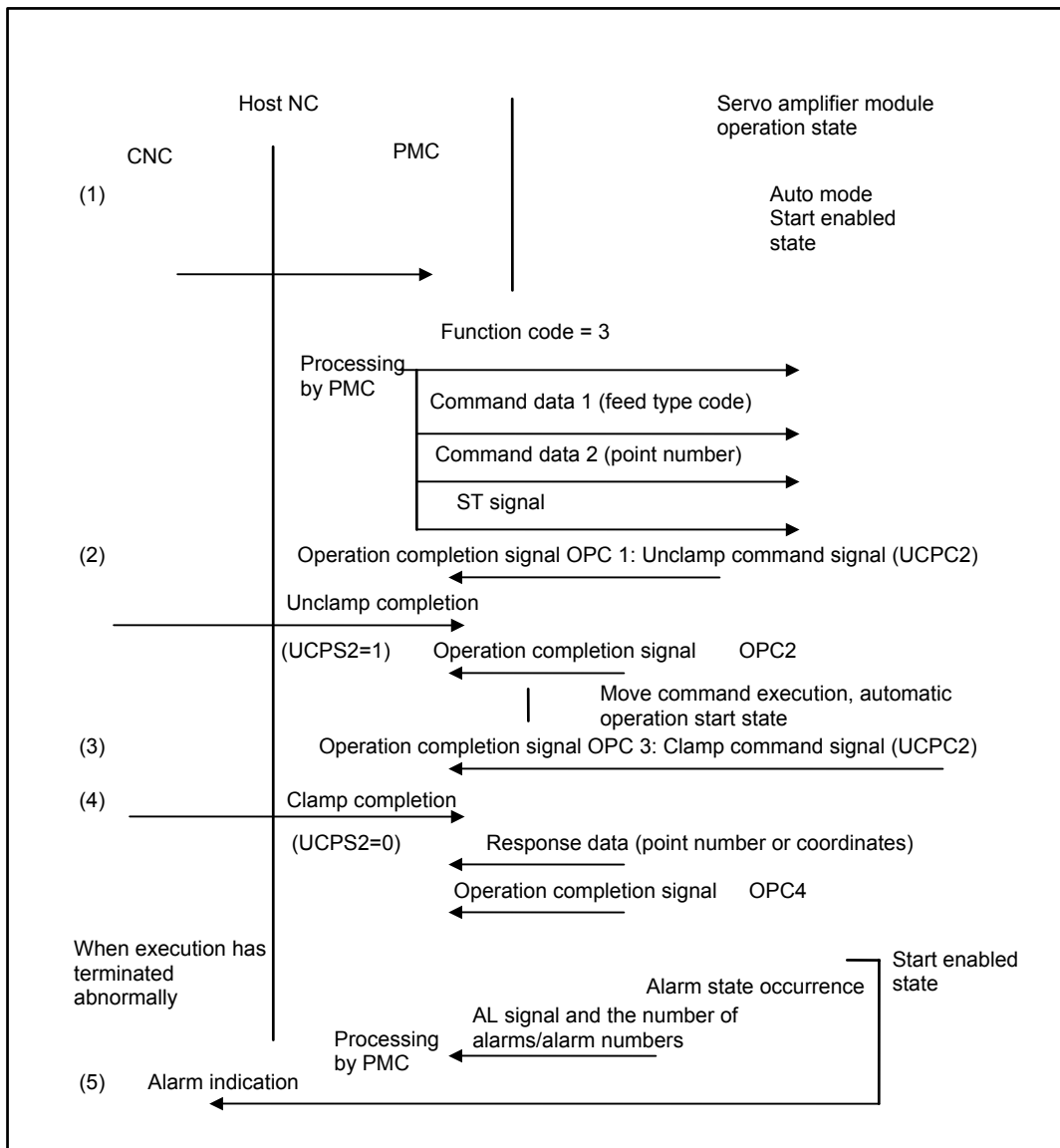

- (1) The PMC on the host NC sets the function code, command data 1, and command data 2, then sends the ST signal to the servo amplifier module. Upon receipt of the data, the servo amplifier module returns the operation completion signal OPC 1 to the host NC, and also outputs the unclamp command signal to the host NC.
- (2) When unclamp completion notification is sent from the host NC, the servo amplifier module returns the operation completion signal OPC 2 to the host NC, and starts movement to the position corresponding to a specified point number.
- (3) Upon completion of the movement, the servo amplifier module returns the operation completion signal OPC 3 to the host NC, and also outputs the clamp command signal to the host NC.

- (4) When clamp completion notification is sent from the host NC, the servo amplifier module returns response data (point number or coordinates) and the operation completion signal OPC 4, and is placed in the start enabled state.
- (5) If an alarm is issued while the servo amplifier module is executing an instruction, the AL signal is output. So, the PMC on the host NC is to perform processing such as alarm indication. In this case, the number of alarms and alarm numbers can be included in the response data by setting the DSAL signal [Subsection 2.3.13.(9)] to 1.

Supplementary information

- 1) The unclamp/clamp command signal and state signal are used for communication with the host NC.
- 2) Whether the unclamp/clamp state signal is to be checked is specified by setting bit 2 (IGCP) of parameter No. 003. When IGCP is set such that no check is performed, the operation completion signal OPC 2 and operation completion signal OPC 3 are not output.
- 3) Use parameter No. 167 to set the period between the servo amplifier module being turned on and the unclamp command signal being output. Use parameter No. 168 to set the period between the clamp command signal being output and the servo amplifier unit being turned off.
- 4) The ST signal can be accepted in the start enabled state only.
- 5) The start enabled state is that state in which the STL signal is off.

3.4.3 Reference Position Return

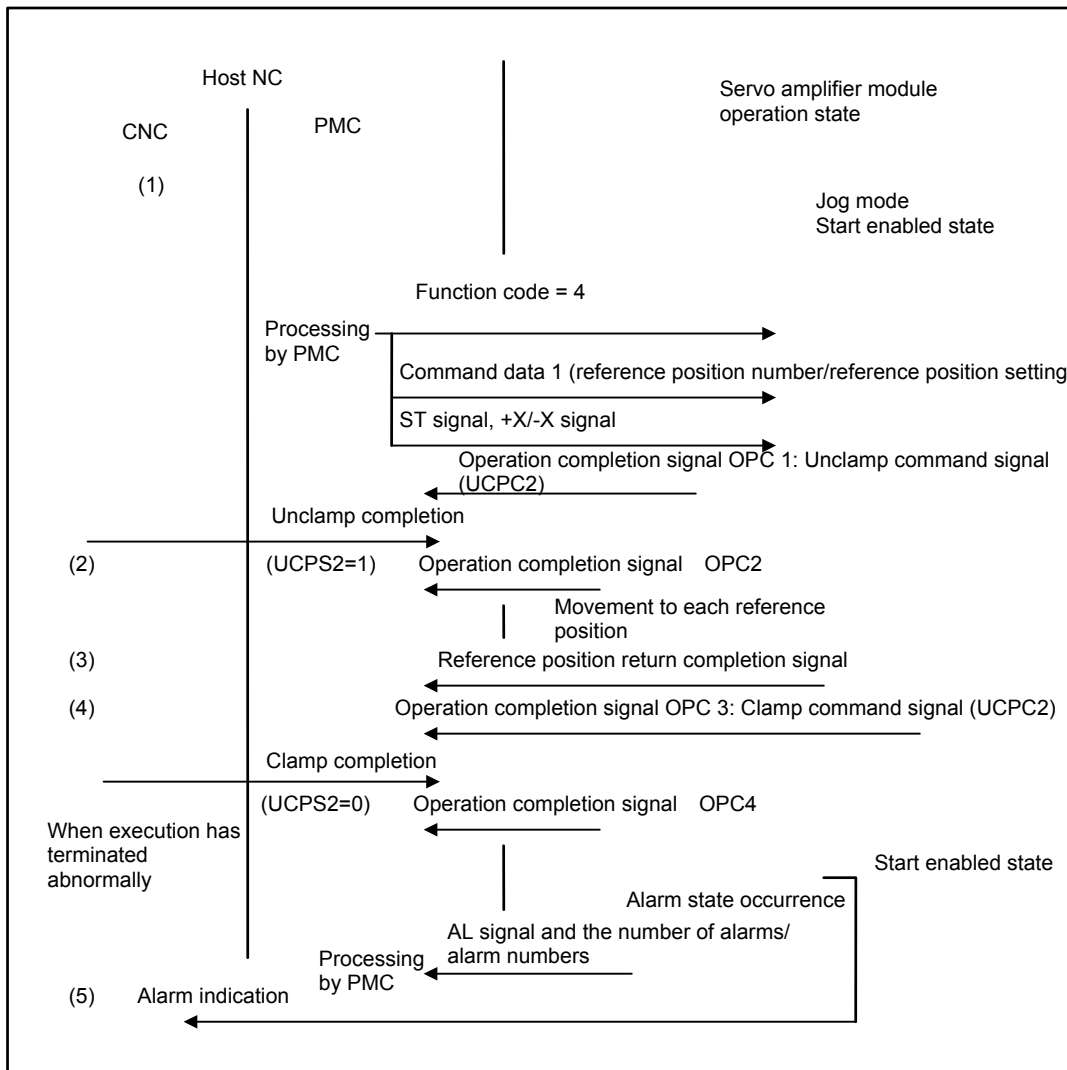

- (1) The PMC on the host NC sets the function code and command data 1, then sends the ST signal or +X/-X signal to the servo amplifier module. Upon receipt of the data, the servo amplifier module returns the operation completion signal OPC 1 to the host NC, and also outputs the unclamp command signal.
- (2) When unclamp completion notification is sent from the host NC, the servo amplifier unit returns the operation completion signal OPC 2 to the host NC, and starts movement to a specified reference position.
- (3) Upon completion of the movement, the servo amplifier module returns the reference position return completion signal and operation completion signal OPC 3 to the host NC, and also outputs the clamp command signal.
- (4) When clamp completion notification is sent from the host NC, the servo amplifier unit returns the operation completion signal OPC 4 to the host NC, enters the start enabled state, then ends the cycle.

- (5) If an alarm is issued while the servo amplifier module is executing a reference position return operation, the AL signal is output. So, the PMC on the host NC is to perform processing such as alarm indication. In this case, the number of alarms and alarm numbers can be included in the response data by setting the DSAL signal [Subsection 2.3.13.(9)] to 1.

Supplementary information

- 1) The unclamp/clamp command signal and state signal are used for communication with the host NC.
- 2) Whether the unclamp/clamp state signal is to be checked specified by setting bit 2 (IGCP) of parameter No. 003. When IGCP is set such that no check is performed, the operation completion signal OPC 2 and operation completion signal OPC 3 are not output.
- 3) Use parameter No. 167 to set the period between the servo amplifier module being turned on and the unclamp command signal being output. Use parameter No. 168 to set the period between the clamp command signal being output and the servo amplifier unit being turned off.
- 4) The ST signal can be accepted only in the start enabled state.
- 5) The start enabled state is that state in which the STL signal is off.

3.4.4 Reference Position Setting (when the Reference Position External Setting Function is Used)

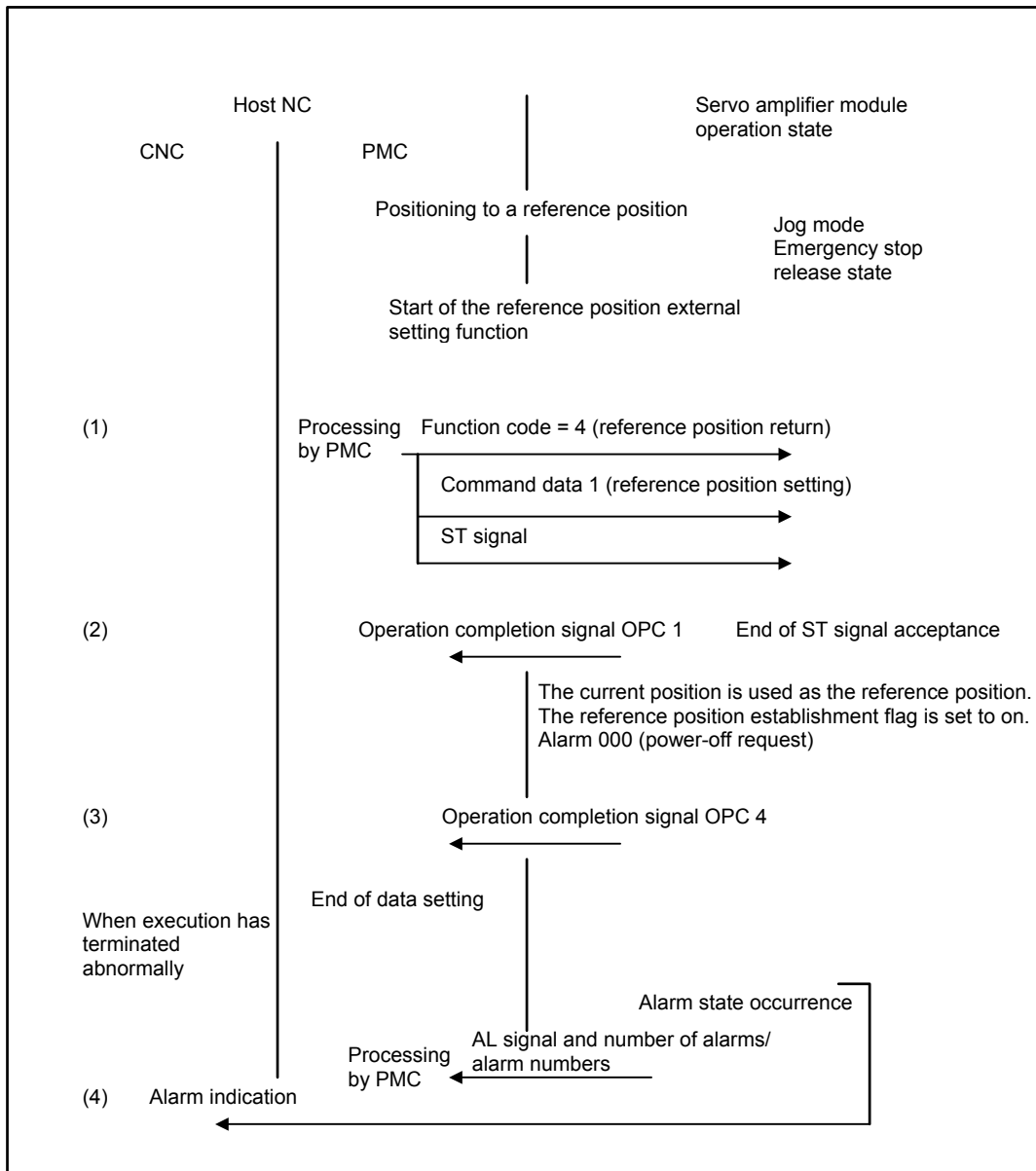

- (1) When the reference position external setting function is used, the PMC on the host NC sets the function code and command data 1, then sends the ST signal to the servo amplifier module after positioning to the reference position.
- (2) Upon receipt of the data, the servo amplifier module returns the operation completion signal OPC 1 to the host NC.
- (3) The servo amplifier module uses the current position as the reference position, sets the reference position establishment flag (bit 0 (ABSX) of parameter No. 011), outputs alarm 000 (power-off request), returns the operation completion signal OPC 4, then terminates.

- (4) If an alarm is issued while the servo amplifier module is executing reference position setting, the AL signal is output. So, the PMC on the host NC is to perform processing such as alarm indication. In this case, the number of alarms and alarm numbers can be included in the response data by setting the DSAL signal [Subsection 2.3.13.(9)] to 1.

Supplementary information

- 1) This function is enabled only when an absolute pulse coder is used.
- 2) The start enabled state is that state where the STL signal is off.

3.4.5 Positioning Control (Absolute/Incremental Specification, for Skip Function)

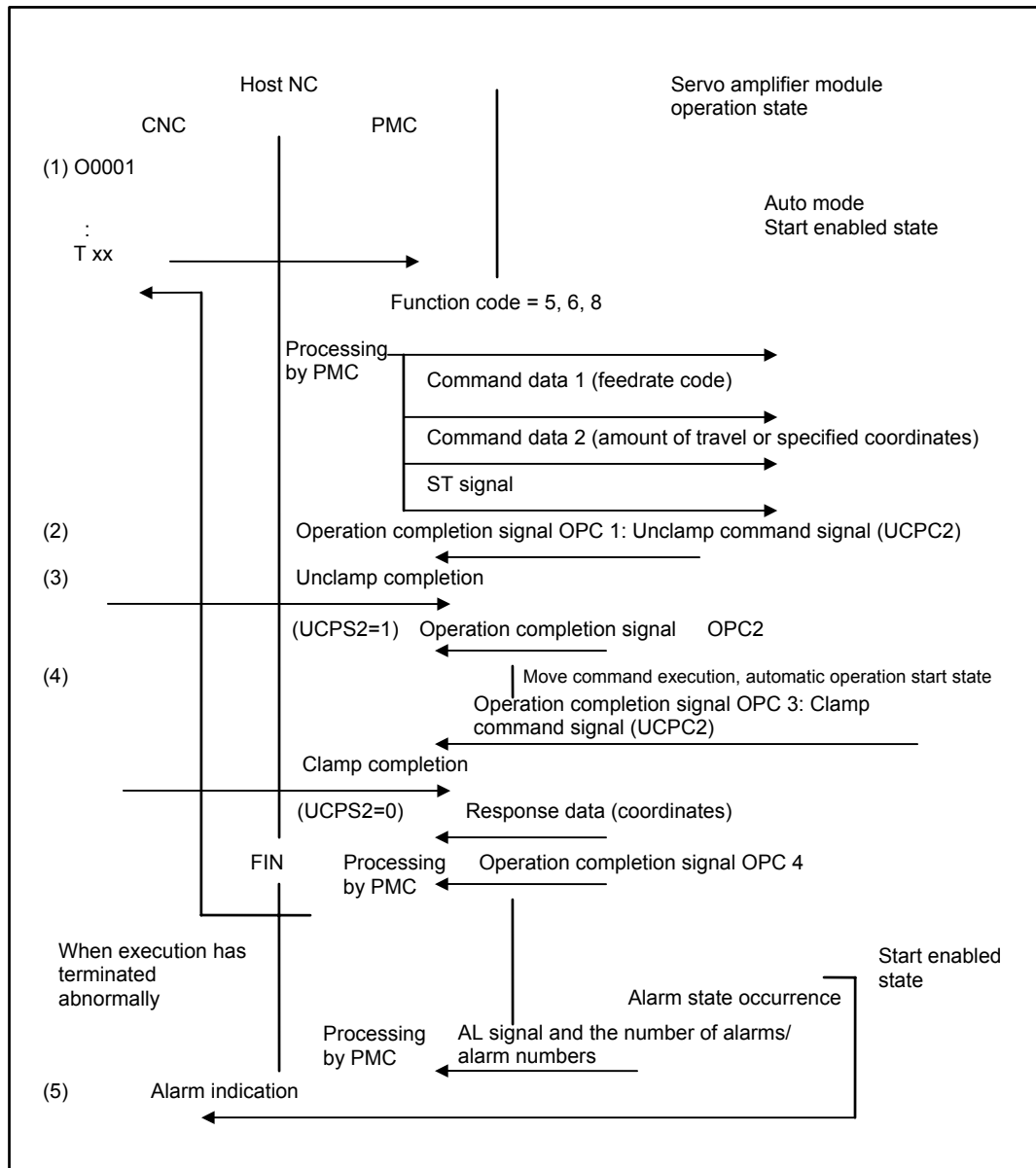

- (1) The PMC on the host NC sets a function code, command data 1, and command data 2, then sends the ST signal to the servo amplifier module. Upon receipt of the data, the servo amplifier module returns the operation completion signal OPC 1 to the host NC, and also outputs the unclamp command signal to the host NC.
- (2) When unclamp completion notification is sent from the host NC, the servo amplifier unit returns the operation completion signal OPC 2 to the host NC, then starts movement. If positioning for the skip function (function code 8) is issued, the skip function with the skip signal (HDI) is enabled. When HDI is input, axis movement is stopped immediately.

- (3) After the end of movement (for the skip function, after the input of HDI), the servo amplifier module returns the operation completion signal OPC3 to the host NC, and at the same time, outputs a clamp command signal to the host NC.
- (4) When clamp completion notification is sent from the host NC, the servo amplifier unit returns response data (coordinates) and the operation completion signal OPC 4, and is placed in the start enabled state.
- (5) If an alarm is issued while the servo amplifier module is executing an instruction, the AL signal is output. So, the PMC on the host NC is to perform processing such as alarm indication. In this case, the number of alarms and alarm numbers can be included in the response data by setting the DSAL signal [Subsection 2.3.13.(9)] to 1.

Supplementary information

- 1) The unclamp/clamp command signal and state signal are used for communication with the host.
- 2) Whether the unclamp/clamp state signal is to be checked is specified by setting bit 2 (IGCP) of parameter No. 003. When IGCP is set such that no check is performed, the operation completion signal OPC 2 and operation completion signal OPC 3 are not output.
- 3) Use parameter No. 167 to set the period between the servo amplifier module being turned on and the unclamp command signal being output. Use parameter No. 168 to set the period between the clamp command signal being output and the servo amplifier unit being turned off.
- 4) The ST signal can be accepted in the start enabled state only.
- 5) The start enabled state is that state in which the STL signal is off.
- 6) With the skip function, the workpiece coordinates at the point the skip signal (HDI) is input are internally recorded. The recorded skip measurement data (workpiece coordinates) can be read as response data by setting parameter No. 20 to "5".

NOTE

- 1 To perform the skip function, bit 0 (HENB) of parameter No. 017 must be set to "1" (use the skip function).
- 2 It is possible to specify, using an appropriate parameter, whether to retain the previous skip measurement data or record the specified end point coordinates if, during the execution of positioning for the skip function, the skip signal (HDI) is not input and the end point is reached. If bit 2 (SPCO) of parameter No. 17 is "0", the previous skip measurement data is recorded; if "1", the specified end point coordinates.
- 3 If reading skip measurement data, confirm the completion of positioning for the skip function (OPC4 = 1) beforehand.
- 4 If, during the execution of positioning for the skip function, the execution is interrupted due to an external reset, emergency stop, alarm, etc., no skip measurement data is updated.

3.4.6 Speed Control

3.4.6.1 Overview

The speed control function executes speed control by specifying a speed value as command data. Moreover, acceleration/deceleration is applied using a time constant (parameter No. 135) dedicated to speed control. Note, however, that acceleration/deceleration based on a time constant is not applied in an emergency stop operation. During speed control, follow-up is performed, thus updating the position. In addition, a change in speed can be specified during speed control. If control is switchable between speed control and position control, an override can be applied to a velocity loop gain for position control when speed control is selected (parameter No. 116).

Speed control is executed in the AUTO mode.

A speed command value can be specified in steps of 1 min^{-1} of the motor, so that the speed control function is useful in controlling the continuous feed of a tool such as a rotation tool.

If a speed deviation check finds that a parameter-set value (parameter No. 136) is exceeded in the speed control mode, an alarm can be issued. Speed control is available in types A and B. The difference is that type B allows specification of the torque limit. During speed control, the torque limit specified in parameter No. 108 has no effect. To make the torque limit take effect, use type B.

3.4.6.2 System configuration

The system configuration is shown below.

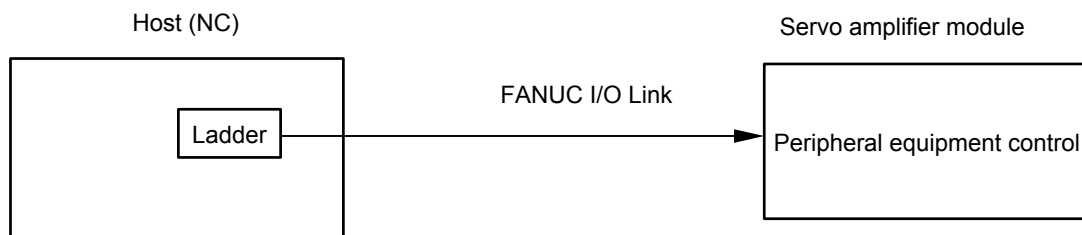

In the configuration above, the host issues a ladder-based command to peripheral equipment control via the FANUC I/O Link to control the servo amplifier module.

With the speed control function, the servo amplifier module first receives the speed command value (and for type B, the torque limit, too) and then starts operation with the ST signal (automatic operation start signal).

3.4.6.3 Peripheral equipment control command format

A speed command value is specified using the following command:
Command (host → servo amplifier module)

	7	6	5	4	3	2	1	0	BIT
Yy+2	Function code				Command data 1				
Yy+3	-----								
Yy+4	Command data 2								
Yy+5	-----								
Yy+6	-----								

Mode : AUTO

Function code : 7

Command data 1 : Specifies speed control activation, a speed change, or stop.

0 : Specifies activation or a speed change.

1 : Specifies a stop.

Command data 2 : <1> Type A

Specifies a speed command value of word type in Yy+3 and Yy+4.

Unit : [min^{-1}]

Valid data range : ± 0 to the maximum speed of the motor

Always set 0 in Yy+5 and Yy+6.

Example) For a speed command of 4000 min^{-1} .

Speed command value = $4000 (= 0FA0\text{h})\text{min}^{-1}$

Yy+3	A0
Yy+4	0F
Yy+5	00
Yy+6	00

<2> Type B

Specifies a speed command value of word type in Yy+3 and Yy+4.

Unit : [min^{-1}]

Valid data range : ± 0 to the maximum speed of the motor

Specifies the torque limit of the motor of word type in Yy+5 and Yy+6.

Valid data range : 0 to 7282

Determine the setting with the following calculation:

Setting = Torque limit [%] x 7282/100

A setting of 0 is assumed to be 100% (7282).

Example) Speed command of 1500 min^{-1} with a torque limit of 50%

Speed command value = $1500 (= 05DCh)\text{min}^{-1}$

Setting of the torque limit = $50\% \times (7282/100) = 3641 (= 0E39\text{h})$

Yy+3	DC
Yy+4	05
Yy+5	39
Yy+6	0E

NOTE

- 1 The maximum speed of the motor depends on the motor used.
- 2 For type B, even if torque limit is not performed (torque limit of 100%), specify 0 or 7282 for the torque limit.
- 3 For type B, to change only the torque limit with the speed unchanged, use the variable speed command. At this time, specify the same speed as that specified the last time.
- 4 For type B, the torque limit cannot be specified with the stop command. After the stop command, the system will return to the torque limit assumed before the start of speed control (determined with parameter No. 108 and bit 2 of parameter No. 10).
- 5 For type B, the specified torque limit is clamped with the setting of parameter No. 080 (current limit).
- 6 Clamping/unclamping cannot be used.

3.4.6.4 Command timing chart

(1) Start of speed control

<1> Type A

Speed control is activated according to the timing chart shown below after the setting of function code = 7, command data 1 = 0, command data 2 = speed command value.



<2> Type B

Speed control is activated according to the timing chart shown below after the setting of function code = 7, command data 1 = 0, command data 2 = speed command value.

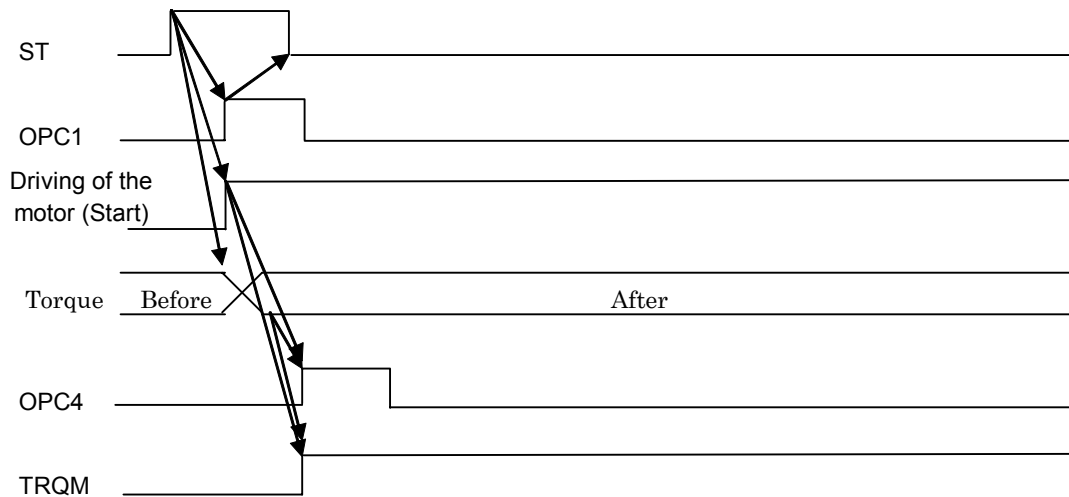

(2) Speed change with speed control

<1> Type A

A speed change based on speed control is activated according to the timing chart shown below after the setting of function code = 7, command data 1 = 0, command data 2 = new speed command value.

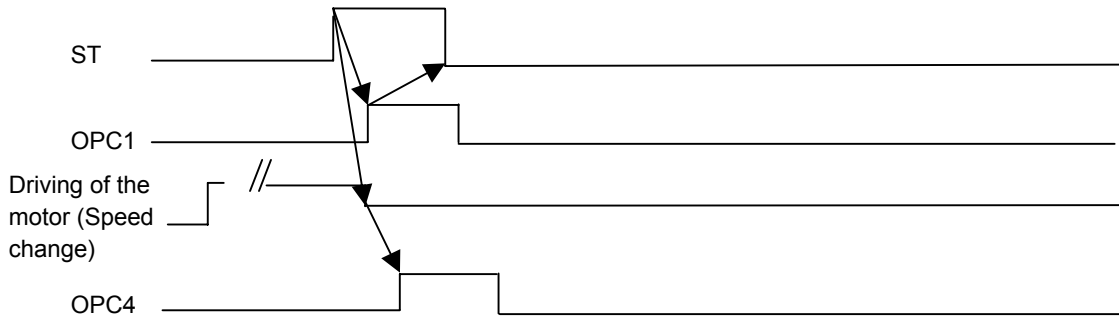

<2> Type B

A speed change based on speed control is activated according to the timing chart shown below after the setting of function code = 7, command data 1 = 0, command data 2 = new speed command value. Use this command also to change the torque limit only.

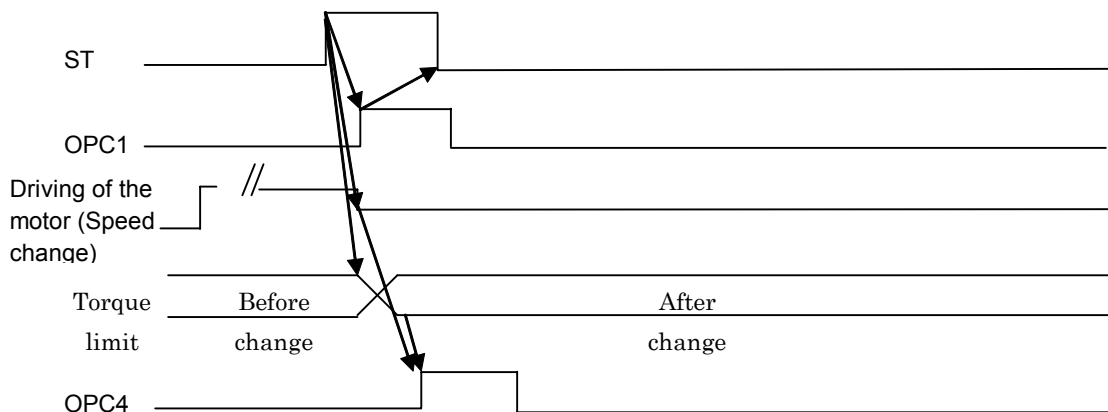

(3) Termination of speed control

<1> Type A

Speed control is terminated according to the timing chart shown below after the setting of function code = 7 and command data 1 = 1.

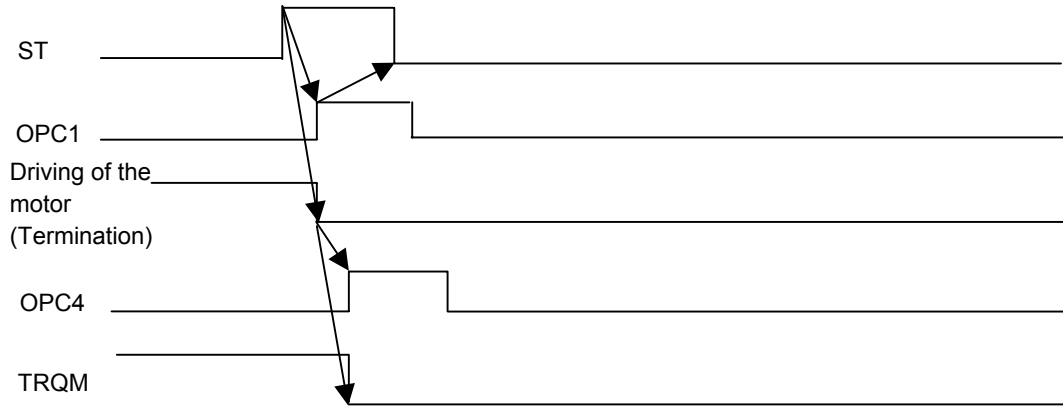

<2> Type B

Speed control is terminated according to the timing chart shown below after the setting of function code = 7 and command data 1 = 1.

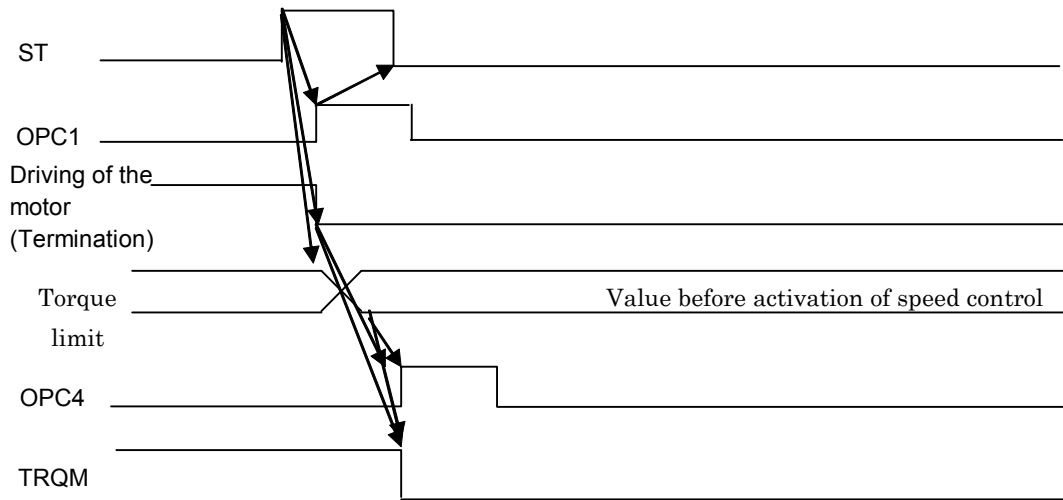

3.4.6.5 Parameter

No	#7	#6	#5	#4	#3	#2	#1	#0
000	ROAX						ROTX	

[Size] 1 byte (bit type)
 [Standard setting value] 0

ROTX Specifies whether the controlled axis is a linear or rotation axis, as follows:
 0 : Linear axis
 1 : Rotation axis
 * To perform speed control, set this bit to "1".

ROAX Specifies whether the roll-over function of the rotation axis is valid, as follows:
 0 : Invalid
 1 : Valid
 * To perform speed control, set this bit to "1".

No	#7	#6	#5	#4	#3	#2	#1	#0
003							NCLP	

[Size] 1 byte (bit type)
 [Standard setting value] 1 only for NCLP

NCLP Specifies whether to use clamping/unclamping, as follows:
 0 : Clamping/unclamping is used.
 1 : Clamping/unclamping is not used.
 * To perform speed control, set this bit to "1".

No	#7	#6	#5	#4	#3	#2	#1	#0
007				VCTLB				

[Size] 1 byte (bit type)
 [Standard setting value] 0

VCTLB The speed control type of peripheral equipment control is:
 0 : Type A (torque limit not specifiable)
 1 : Type B (torque limit specifiable)

		No	
		100	Load inertia ratio (LDINT)
	[Size]	2-byte	
	[Valid data range]	0 to 1024	
		<p>Set the ratio of the machine load inertia to the motor inertia, using a value obtained from the formula below as a guideline.</p> <p>Load inertia ratio = (machine load inertia/motor inertia) × 256</p> <p>If a value obtained by calculation exceeds 500, however, set 500. When a value is set in this parameter, the velocity loop gain is set to PK1V, and PK2V is increased by a factor of (1 + LDINT)/256.</p> <p>As a larger value is set in this parameter, the response to a velocity command improves, and servo rigidity increases. If an excessively large value is set, however, the servo system vibrates, and an unusual sound is generated during machine movement. Usually, set a value not exceeding 500. If the machine vibrates at a high frequency, the use of the torque command filter of parameter No. 102 is effective.</p>	
		No	
		116	Velocity loop gain override during speed control (%)
	[Size]	2-byte	
	[Standard value]	0 (Override processing is not performed.)	
		<p>Set this parameter when switching between position control and speed control. When the speed control mode is set, an override specified here is applied to the velocity loop gain and integration gain used for position control.</p> <p>The relationships among a velocity loop proportional gain, integration gain, load inertia ratio, and velocity loop gain override in speed control are explained below using an example. Assume the following:</p> <p>Integration gain = 100</p> <p>Proportional gain = -500</p> <p>Load inertia ratio = 128</p> <p>Velocity loop gain override in speed control = 200%</p> <p>[Gain in position control]</p> <p>Integration gain = $100 \times (1 + 128/256) = 150$</p> <p>Proportional gain = $-500 \times (1 + 128/256) = -750$</p> <p>[Gain in speed control]</p> <p>Integration gain = $100 \times (1 + 128/256) \times 200/100 = 300$</p> <p>Proportional gain = $-500 \times (1 + 128/256) \times 200/100 = -1500$</p> <p>Thus, when speed control is exercised, a gain override is applied to a gain that takes a load inertia ratio into consideration.</p>	

No
135 Linear acceleration/deceleration time constant for speed control

[Size] 2-byte
 [Unit of data] ms
 [Valid data range] 8 to 4000

Specify a time required until 4000 min⁻¹ is reached.
 Example)
 When a speed command value of 2000 min⁻¹ is specified, and the time required until 2000 min⁻¹ is reached needs to be 1000 ms, the value to be set in this parameter is calculated as follows:
 Setting = (4000/2000) × 1000 = 2000

No
136 Speed deviation check limit value in speed control

[Size] 2-byte
 [Unit of data] min⁻¹
 [Valid data range] 0 to 4000
 [Standard setting value] 0 (No speed deviation check is made.)

Set a speed deviation check limit value in the speed control mode. If the difference between a command speed and actual speed exceeds the value set in this parameter in the speed control mode, alarm No. 447 is issued.

3.4.6.6 Signal

7	6	5	4	3	2	1	0	BIT
Xx+2					TRQM			

Speed control mode signal TRQM

[Classification] Input signal <Xx+2#2>
 [Function] The servo amplifier module notifies that the speed control mode is set.
 [Input condition] The signal becomes 1 when:
 1. When speed control is activated, and the speed control mode is set
 The signal becomes 0 when:
 1. When the speed control stop command is executed
 2. Servo alarm, overtravel alarm, reset, emergency stop, servo-off

3.4.6.7 Alarm

No.	LED indication	Description	Action
254		Function code or mode is invalid.	Check the value specified as the function code of a function code command. Check the mode.
255		Activation is impossible because the activation mode is different or a block is being executed.	Check the mode. Check if a block is being executed.
447		Excessive speed deviation (speed control)	Check the actual speed. Check the setting of parameter No. 136.

3.4.6.8 Others

- (1) To exercise speed control, the parameters below usually need to be modified.

Do not modify parameters other than the parameters below.

No.000 (bit 1) : Set this bit to 1 (rotation axis specification).

No.000 (bit 7) : Set this bit to 1 (to enable rotation axis roll-over).

No.003 (bit 1) : Set this bit to 1 (not use clamping/unclamping).

No.007 (bit 4) : 0 if type A and 1 if type B.

No.100 : Load inertia ration. Set an adjusted value.

The parameters below are dedicated to speed control. So, once these parameters are set, they need not be modified each time control is switched to speed control.

No.116 : Velocity loop gain override in speed control. (Set this parameter when switching between position control and speed control.)

No.135 : Linear acceleration/deceleration time constant for speed control

No.136 : Speed deviation check limit value in speed control

- (2) In the speed control mode, the processing described below is performed based on output signals.

When the overtravel alarm is issued, a gradual stop occurs, and the speed control mode is terminated. When the external reset signal ERS (Yy+1#0) is set to 1, a gradual stop occurs, and the speed control mode is terminated. When the interlock signal *ILK (Yy+1#3) is set to 0, a gradual stop occurs. When the interlock signal is set to 1 again, acceleration is performed to restart a movement.

When the servo-off command signal SVFX (Yy+1#2) is set to 1, a gradual stop occurs, and the speed control mode is terminated.

- (3) The states of input signals in the speed control mode are described below.

Follow-up is performed for position updating, so that the axis movement in-progress signal MVX (Xx+7#2) and the distribution pulse signal IPLX (Xx+0#1) are set to 1.

During movement in one direction, the movement direction signal MVDX (Xx+7#0) is set to 1.

The automatic operation signal OP (Xx+1#7) and the automatic operation start in-progress signal STL (Xx+1#5) are set to 1.

Clamp/unclamp control is disabled in the speed control mode, so that the unclamp command signal UCPC2 (Xx+1#4) is not set to 1.

3.4.7 Coordinate System Setting

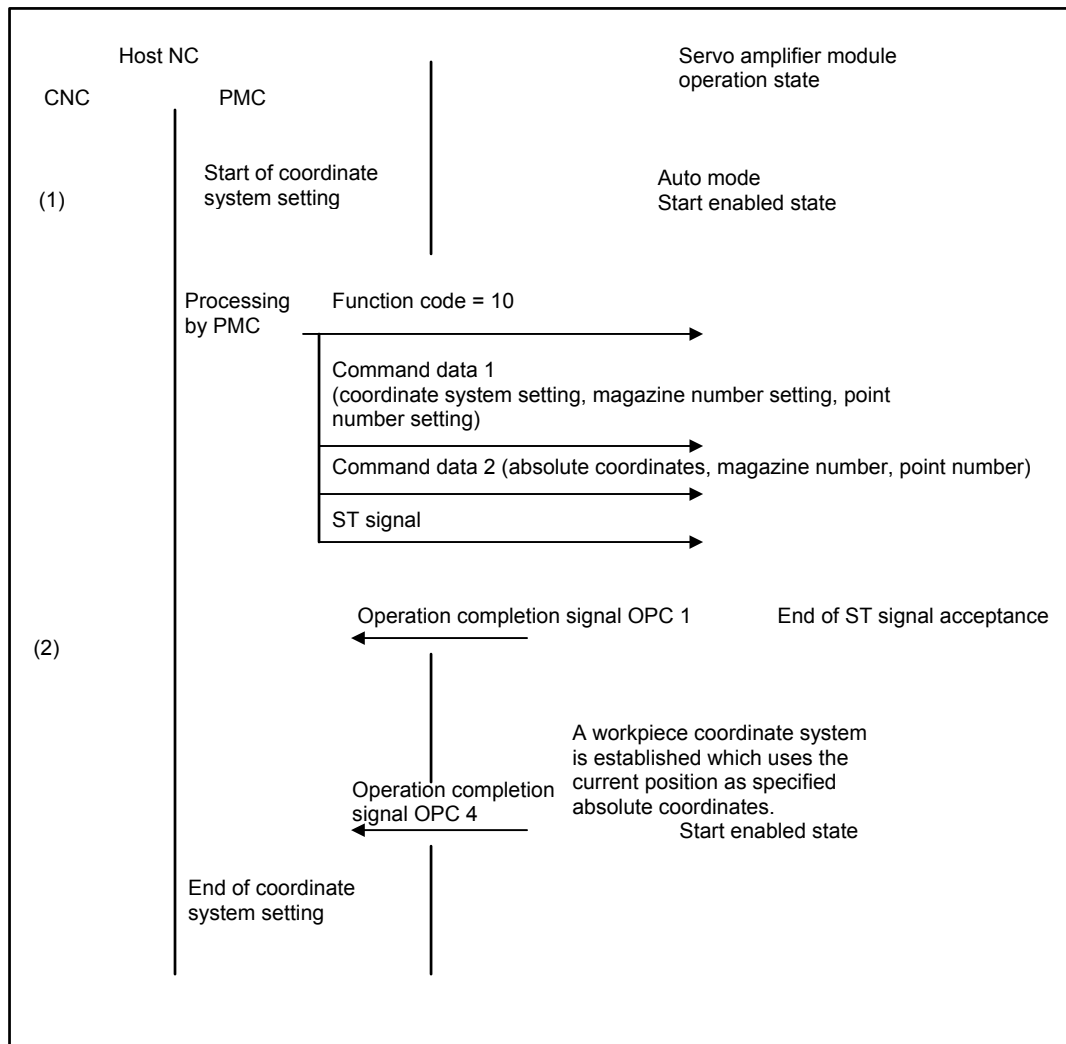

- (1) In coordinate system setting, the PMC on the host NC sets the function code, command data 1, and command data 2, then sends the ST signal to the servo amplifier module. Upon receipt of the data, the servo amplifier module returns the operation completion signal OPC 1 to the host NC.
- (2) Upon completion of coordinate system setting, the servo amplifier module returns the operation completion signal OPC 4, and is placed in the start enabled state.

Supplementary information

- 1) The start enabled state is that state in which the STL signal is off.

3.4.8 Rewriting of Parameters

3.4.8.1 Overview

When using the peripheral equipment control parameter rewrite function, specify 12 as function code, a data size as command data 1, a parameter number and parameter value as command data 2, and start operation with the ST signal. For a double-word parameter, specify a parameter value twice. Parameter rewrite operation is performed in the emergency stop state. However, if operation is not being performed, the following parameter can be rewritten in a state other than the emergency stop state:

- Parameter No. 20

⚠ CAUTION

The number of times the memory (EEPROM) for holding parameters can be rewritten to is limited (to several ten thousands times), so the memory does not allow frequent rewriting. For an application that rewrites parameters frequently, bit 3 (NEPRM) of parameter No. 0004 needs to be set to 1 to modify RAM data only without writing to the EEPROM.

3.4.8.2 System configuration

The system configuration is shown below.

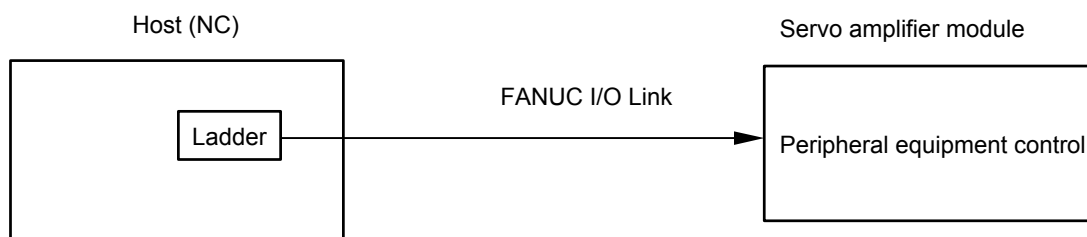

In the configuration above, the host issues a ladder-based command to peripheral equipment control via the FANUC I/O Link to control the servo amplifier module. With the parameter rewrite function, the servo amplifier module receives command data for parameter rewrite operation, then executes parameter rewrite operation with the ST signal (automatic operation start signal).

3.4.8.3 Peripheral equipment control command format

A parameter to be rewritten is specified using the following command:
Command (host → servo amplifier module)

	7	6	5	4	3	2	1	0
Yy+2	Function code				Command data 1			
Yy+3	-----							
Yy+4	Command data 2							
Yy+5	-----							
Yy+6	-----							

Function code : 12

Command data 1 :

- 1 : Rewrites a byte parameter.
- 2 : Rewrites a word parameter.
- 3 : Rewrites a double-word parameter (first time).
- B : Rewrites a double-word parameter (second time).

Command data 2 :

- Sets the number of a parameter to be rewritten in Yy+3 and Yy+4.
- Sets the value of a parameter to be rewritten in Yy+5 and Yy+6.

Data type

1) Byte type

Yy+5	
------	--

Example: Number 22, data 5

Yy+3=16 [hexadecimal], Yy+4=00

Yy+5=05 [hexadecimal], Yy+6=00

2) Word type

Yy+5	
Yy+6	

Data = higher byte × 256 + lower byte

- When rewriting a double-word parameter, divide the value of the parameter into two for two specifications.

Example: Number 140, data 500000

500000=0007A120 [hexadecimal]

First time:

Yy+3=8C [hexadecimal], Yy+4=00

Yy+5=20 [hexadecimal], Yy+6=A1 [hexadecimal]

Second time:

Yy+3=8C [hexadecimal], Yy+4=00

Yy+5=07 [hexadecimal], Yy+6=00

3.4.8.4 Command timing chart

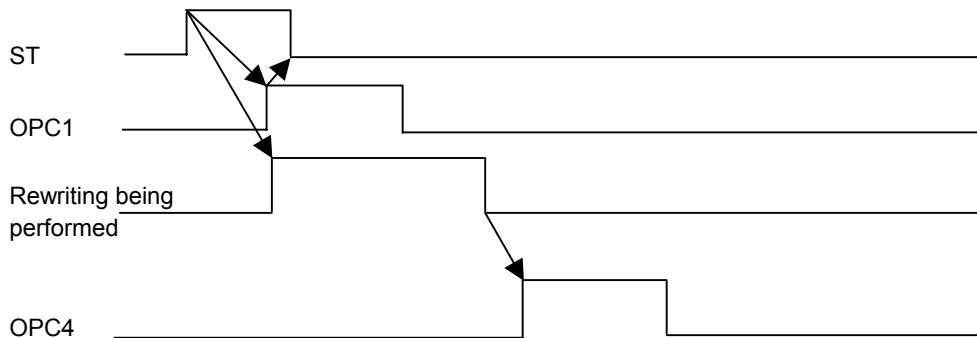

3.4.8.5 Alarm

No.	LED indication	Description	Action
250	<input type="checkbox"/> <input checked="" type="checkbox"/> <input checked="" type="checkbox"/> <input checked="" type="checkbox"/> <input checked="" type="checkbox"/> <input type="checkbox"/> <input type="checkbox"/>	Command data 1 or the instruction command is invalid.	Check the specified value of command data 1 of a function code command.
251	<input type="checkbox"/> <input checked="" type="checkbox"/> <input checked="" type="checkbox"/> <input checked="" type="checkbox"/> <input checked="" type="checkbox"/> <input type="checkbox"/> <input type="checkbox"/>	Command data 2 is invalid.	Check the specified value of command data 2 of a function code command.
254	<input type="checkbox"/> <input checked="" type="checkbox"/> <input checked="" type="checkbox"/> <input checked="" type="checkbox"/> <input checked="" type="checkbox"/> <input type="checkbox"/> <input type="checkbox"/>	Function code or mode is invalid.	Check the specified value of function code of a function code command. Check the mode.

3.4.8.6 Parameter

No	#7	#6	#5	#4	#3	#2	#1	#0
004					NEPRM			

[Size] 1 byte (bit type)
 [Standard value] 0

NEPRM When the peripheral equipment control parameter rewrite function is executed, writing to the EEPROM (memory for holding parameters) is:
 0 : Performed.
 1 : Not performed.

⚠ CAUTION

- 1 For an application that rewrites parameters frequently with the peripheral equipment control parameter rewrite function, set this parameter to 1.
- 2 The setting of this parameter is applicable to the rewriting of parameters using a direct command.

3.4.9 Control of the Point Data External Setting Function

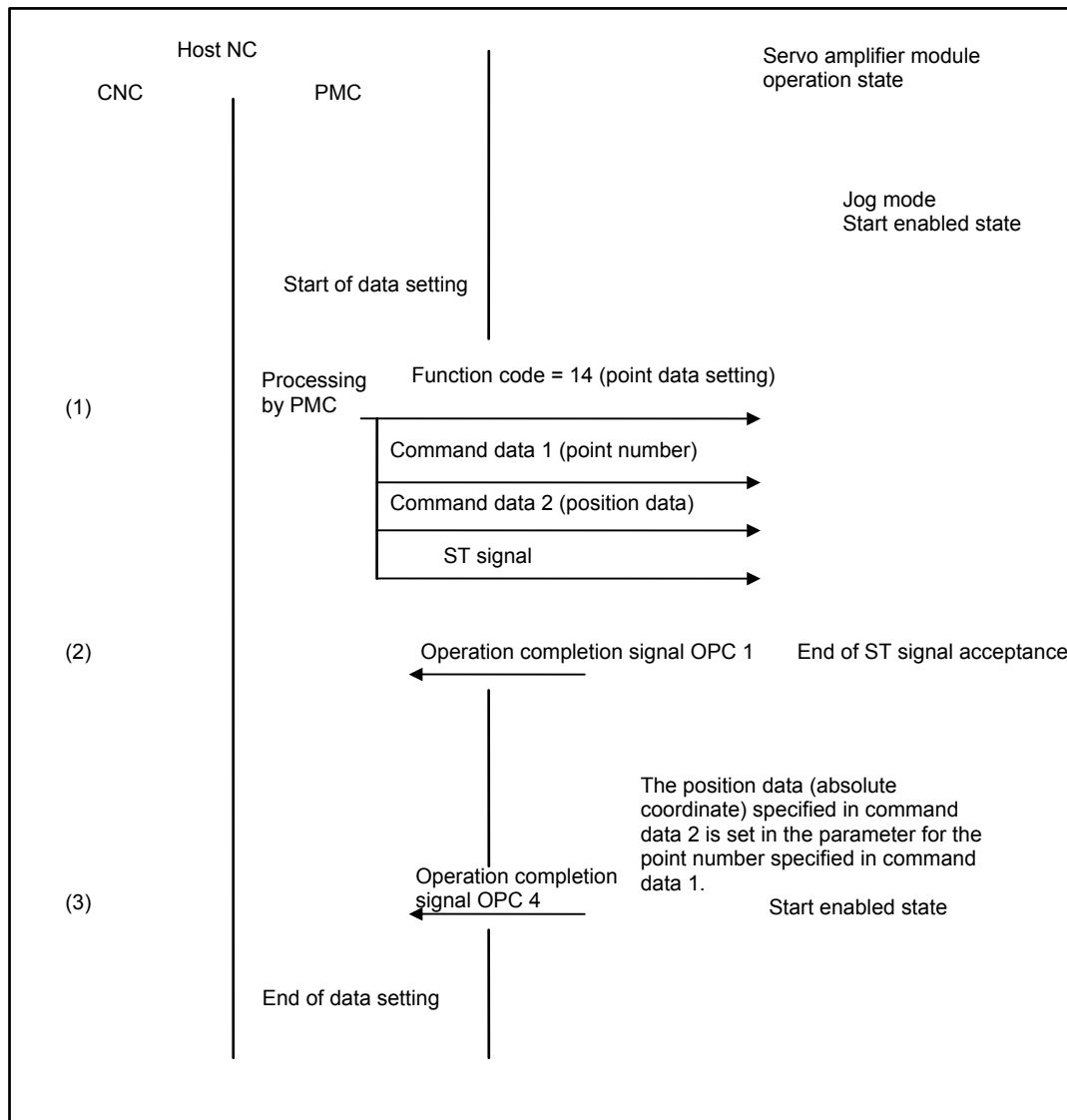

- (1) In data setting, the PMC on the host NC sets the function code, command data 1, and command data 2, then sends the ST signal to the servo amplifier module.
- (2) When the function code, command data 1, and command data 2 are received, the servo amplifier module returns the operation completion signal OPC 1 to the host NC.
- (3) Upon the completion of setting data in the parameter, the servo amplifier module returns the operation completion signal OPC 4.

Supplementary information

- 1) The start enabled state is that state in which the STL signal is off.

3.4.10 Teaching-based Data Setting Control

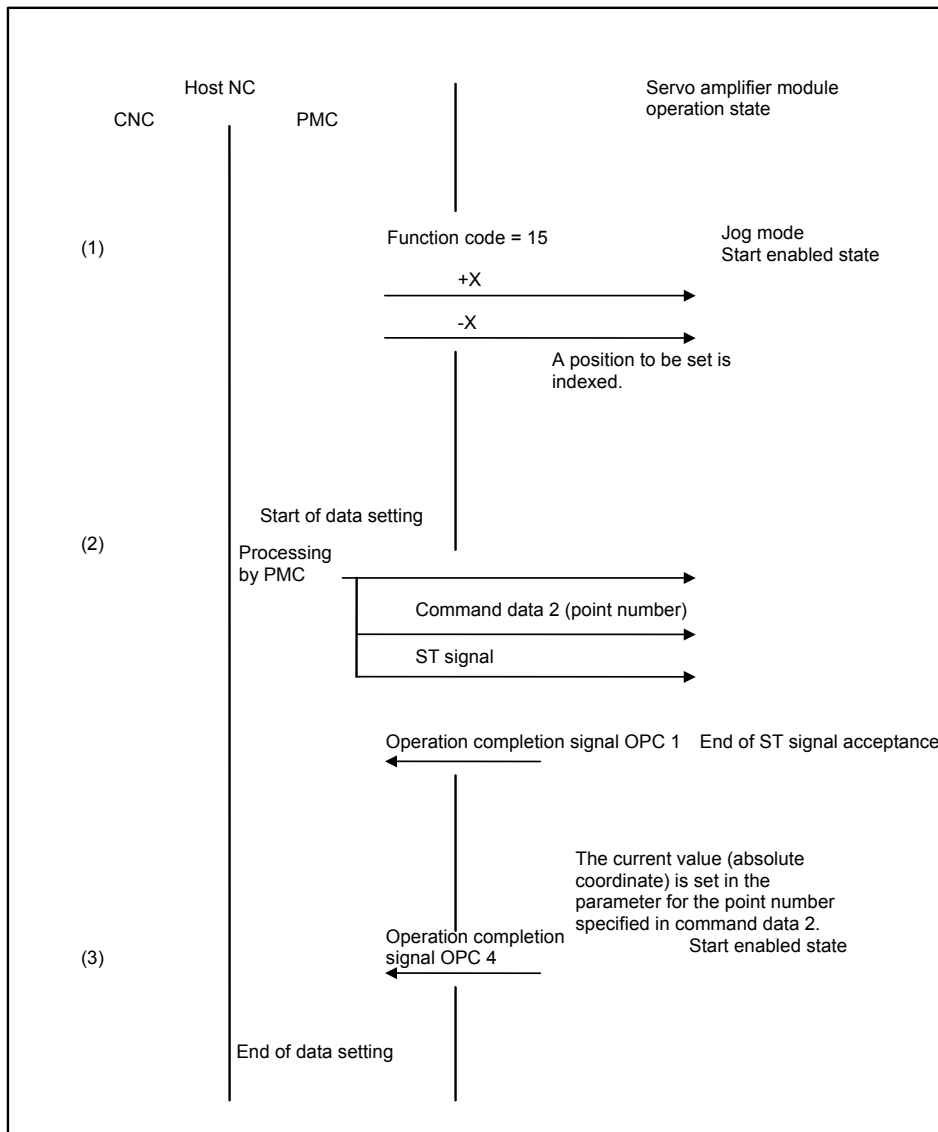

- (1) After function code setting, the host NC indexes a position according to the +X/-X signal.
- (2) In data setting, the PMC on the host NC sets the function code and command data 2, then sends the ST signal to the servo amplifier module. Upon receipt of command data 2, the servo amplifier module returns the operation completion signal OPC 1 to the host NC.
- (3) Upon the completion of setting the current value in a parameter, the servo amplifier module returns the operation completion signal OPC 4, and is placed in the start enabled state.

Supplementary information

- 1) The coordinate for a point number is set in the parameter area.
- 2) Perform teaching-based data setting while no movement is being performed along the axes.
- 3) The start enabled state is that state in which the STL signal is off.

3.5 REFERENCE POSITION RETURN FUNCTION WITH DOGS

3.5.1 Explanation of Function

This function moves the machine movable part automatically or manually in a specified direction to return to a reference position. This method of reference position return is referred to as the grid method. With this method, a reference position is determined by an electronic grid position determined by the one-rotation signal of a position detector.

The deceleration signal for reference position return (*DEC) is placed in the same position as the high-speed interlock signal (*RILK) on the built-in DI. So, when the reference position return function with dogs is used, the high-speed interlock signal (*RILK) cannot be used.

3.5.1.1 Reference position return operation (grid method)

The machine movable part moves by rapid traverse when the jog feed mode is set, 4 is set as function code, 15 is set as command data 1, and feed toward a reference position is specified using the feed axis and direction select signal (+X or -X).

If the deceleration signal for reference position return (*DEC) is set to 0 because a deceleration limit switch is pressed, the feedrate is reduced, then movement continues at a low constant feedrate.

When an electronic grid position is reached after the deceleration limit switch is released and the deceleration signal for reference position return is set to 1 again, feed operation stops. At this time, the reference position return completion signal (ZPX) is set to 1.

A reference position return direction can be set in a parameter.

The operation described above is shown in the timing chart below.

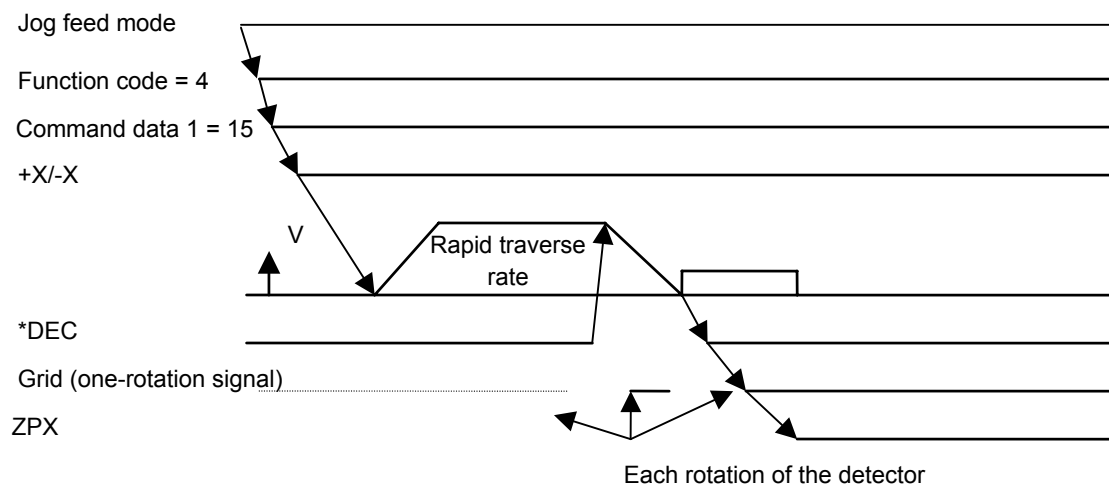

A gradual stop occurs if a mode other than the jog feed mode is selected or the feed axis direction command signal (+X or -X) is turned off during reference position return. Reference position return must start at a point sufficiently away from a deceleration area and must be performed in the direction toward the reference position. The deceleration area is as shown below.

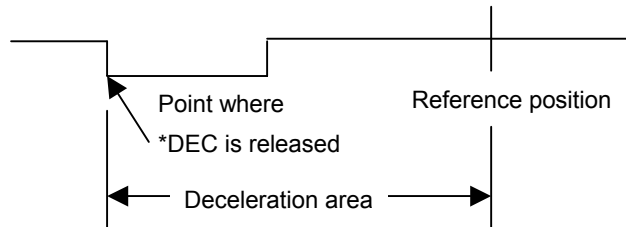

A low constant feedrate after deceleration is set using parameter No. 054.

NOTE

- 1 If the direct command interface is used, select the AUTO mode and input 60H as function code, then invert the EBUF signal. Then, the machine movable part moves by rapid traverse for reference position return operation.
- 2 If a reference position is already established, the machine is always positioned by rapid traverse at the reference position.

3.5.1.2 Deceleration limit switch installation condition

When a deceleration limit switch for reference position return is installed, the condition shown below must be satisfied.

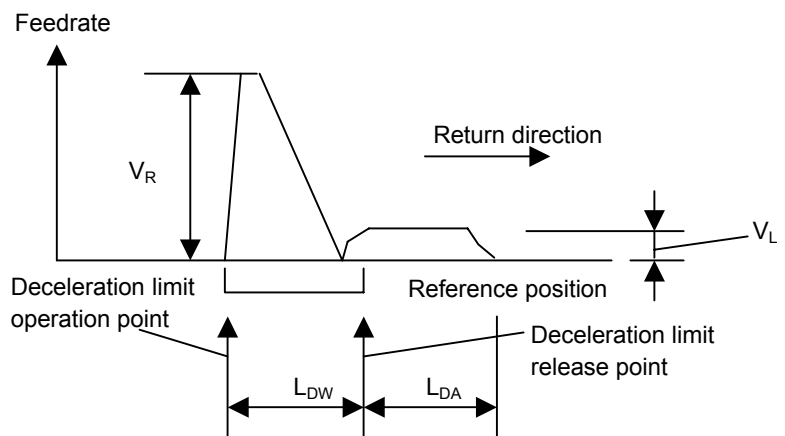

- (i) L_{DW} : Deceleration dog width (user unit)
 $L_{DW} > (V_R((T_R/2)+1+T_S)+4V_L \times T_S)/60000$
 V_R :Rapid traverse rate (user unit/min)
 T_R :Rapid traverse time constant (msec)
 T_S :Servo time constant (msec)
 V_L :Feedrate after deceleration (user unit/min)
- (ii) L_{DA} :Distance between the deceleration limit switch release point and reference position
 L_{DA} :Travel distance equivalent to a half rotation of the motor
 The condition above does not include limit switch operation variation. Consider such variation into consideration when installing a limit switch.

3.5.1.3 Tip

To perform reference position return according to the sequence mentioned here, the machine must be fed once in the reference position return direction at such a feedrate that the servo positional deviation exceeds 128, before the first reference position return operation. A servo positional deviation (E) is determined from a feedrate (F) and servo loop gain (G).

$$E=(F/G) \times (1/U)$$

E:Servo positional deviation (user unit)

F:Feedrate (user unit/sec)

U:Detection unit (user unit)

G:Servo loop gain

In general, the detector unit is one user unit.

When the machine is fed at a rapid traverse rate of 6000000 user units/min, the servo positional deviation in the steady state is as follows if the position loop gain is 30:

$$E=((6000000/60)/30) \times (1/1) =3333$$

On the contrary, such a feedrate that the servo positional deviation is 128 is as follows if the detection unit is one user unit, and the servo loop gain is 30:

$$F=128 \times 30 \times 60=230,400 \text{ (user unit/min)}$$

This means that when the servo loop gain is 30, and the detection unit is one user unit, the machine needs to be fed in the reference position return direction at a feedrate of 230400 user units/min or more before reference position return. A servo positional deviation present when the machine is actually fed can be checked using DGN No. 032.



CAUTION

When this function is used, the high-speed interlock signal is disabled.

3.5.2 Parameter

No	#7	#6	#5	#4	#3	#2	#1	#0
011						DZRN		

[Size] 1 byte (bit type)
 [Standard value] 0

DZRN The reference position return function with dogs is:
 0 : Disabled. (The reference position return function without dogs is selected.)
 1 : Enabled.

 **CAUTION**
 When DZRN = 1, the high-speed interlock signal (*RILK) is disabled.

3.6 UPGRADING OF THE ROTATION AXIS CONTROL FUNCTION

3.6.1 Function for Specifying the Direction of Rotation Axis High-speed Reference Position Return

3.6.1.1 Explanation of function

The direction of high-speed reference position return of a rotation axis after reference position establishment is set using bit 5 (ZMIX) of parameter No. 0010.

3.6.1.2 Parameter

No	#7	#6	#5	#4	#3	#2	#1	#0
005						REFDRC		
[Size]	1 byte (bit type)							
[Standard value]	0							
REFDRC	The direction of high-speed reference position return of a rotation axis is determined by: 0 : Sign of the result of subtracting the current position from the reference position 1 : Setting of bit 5 (ZMIX) of parameter No. 0010							
No	#7	#6	#5	#4	#3	#2	#1	#0
010			ZMIX					
[Size]	1 byte (bit type)							
[Standard value]	0							
ZMIX	When bit 2 (REFDRC) of parameter No. 0005 is set to 1, the direction of high-speed reference position return of a rotation axis is: 0 : Plus direction 1 : Minus direction							

NOTE

- 1 This function is enabled only when a rotation axis is set (when bit 1 (ROTX) of parameter No. 0000 = 1).
- 2 When shortcut rotation is enabled (when both bit 6 (RABX) and bit 7 (ROAX) of parameter No. 0000 are set to 1), this function is disabled.

3.6.2 Rotation Axis Rotation Direction Sign Specification Function

3.6.2.1 Explanation of function

With an absolute command for a rotation axis, a rotation direction can be specified using a sign.

3.6.2.2 Example of program

When parameter No. 0141 for specifying the travel distance of one rotation of a rotation axis is set to 360000, and the current position is 100000, specify 300000 with an absolute command to move by rotation in the plus direction to the position of 300000. At this time, the travel distance is as follows:

Travel distance: $300000 - 100000 = +200000$

To move by rotation in the minus direction to the position of 300000, specify -300000 with an absolute command. At this time, the travel distance is as follows:

Travel distance = $(300000 - 100000) - 360000 = -160000$

3.6.2.3 Parameter

No	#7	#6	#5	#4	#3	#2	#1	#0
000						RAB2X		

[Size] 1 byte (bit type)
 [Standard value] 0

RAB2X The specification of the rotation direction sign of a rotation axis with an absolute command is:
 0 : Disabled.
 1 : Enabled.

NOTE

- 1 This function is enabled only when roll-over is set (when both bit 1 (ROTX) and bit 7 (ROAX) of parameter No. 0000 are set to 1).
- 2 When shortcut rotation is enabled (when both bit 6 (RABX) and bit 7 (ROAX) of parameter No. 0000 are set to 1), this function is disabled.
- 3 When this function is used to specify an absolute value of 0 based on rotation in the minus direction, specify a travel distance of one rotation. For example, when the travel distance of one rotation is 360000, and an absolute value of 0 is to be specified based on rotation in the minus direction, specify -360000.

3.7 UPGRADING OF THE CLAMP/UNCLAMP CONTROL FUNCTION

3.7.1 Start of the Timer Counting Until Servo-off in Clamp Processing

3.7.1.1 Explanation of function

In clamp processing, the timer (parameter No. 0168) counting until servo-off can be started when the clamp/unclamp state output signal is turned off.

3.7.1.2 Parameter

No	#7	#6	#5	#4	#3	#2	#1	#0
005							CLPSVF	

[Size] 1 byte (bit type)
[Standard value] 0

CLPSVF As a period of time from the start of clamp processing to servo-off (parameter No. 0168):
0 : Time after the unclamp command signal (UCPC2) is turned off is set.
1 : Time after the clamp/unclamp state output signal (UCPS2) is set.

3.7.2 Disabling of Clamp Processing When Jog Operation is Stopped

3.7.2.1 Explanation of function

When jog operation is stopped, clamp processing is not performed, but the unclamp state can be held.

3.7.2.2 Parameter

No	#7	#6	#5	#4	#3	#2	#1	#0
005								JNCL

[Size] 1 byte (bit type)
[Standard value] 0

JNCL When jog operation is stopped, clamp processing is:
0 : Performed.
1 : Not performed. (The unclamp state is held.)

3.8 UPGRADING OF THE RESPONSE DATA READ FUNCTION

3.8.1 Overview

At present, response data cannot be read for a purpose other than display during operation such as movement on axes.

This function allows the host to read correct response data from a servo amplifier unit even during movement on axes by establishing synchronization between the host and servo amplifier module with the response data read function of the host. Note, however, that the ATC and point numbers are not updated until the end of a command. The ATC number can be updated at all times as described in Section 3.9, "Improvement of Turret/Magazine Number Output".

3.8.2 Details of Function

For synchronization establishment, the following two bits are added onto the I/O Link:

ABSWT ($Xx+1\#0$): Response data write completion signal

ABSRD ($Yy+1\#4$): Response data read completion signal

[Details of processing]

When the logic levels of ABSWT and ABSRD are equal ($ABSWT = ABSRD = 0$ or $ABSWT = ABSRD = 1$), the servo amplifier module writes response data to $Xx+3$ to $Xx+6$, and inverts the logic level of ABSWT.

When the logic levels of ABSWT and ABSRD are not equal ($ABSWT = 0$ and $ABSRD = 1$, or $ABSWT = 1$ and $ABSRD = 0$), the host takes in response data from $Xx+3$ to $Xx+6$, and inverts the logic level of ABSRD.

[Timing chart]

H : Processing by the host

β : Processing by the servo amplifier module

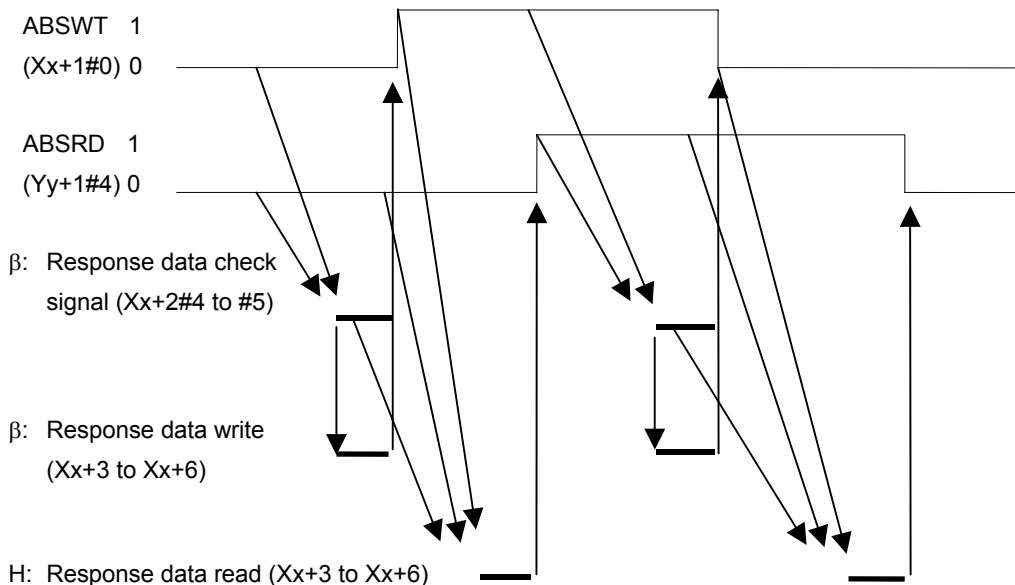

3.8.3 DI/DO Signals

The DI/DO signals are signals on the FANUC I/O Link.

	7	6	5	4	3	2	1	0
Yy+1				ABSRD				
	7	6	5	4	3	2	1	0
Xx+1								ABSWT
	7	6	5	4	3	2	1	0
Xx+2			DSP2	DSP1				

Response data write completion signal ABSWT

- [Classification] Input signal <Xx+1#0> (peripheral equipment control only)
- [Function] After writing response data (Xx+3 to Xx+6), the servo amplifier module inverts this signal for notification to the host.
- [Operation] The servo amplifier module exclusive-ORs ABSWT with ABSRD. If the result of exclusive-OR is 0, the servo amplifier module writes response data (Xx+3 to Xx+6), and inverts this signal.

Response data read completion signal ABSRD

- [Classification] Output signal <Xx+1#4> (peripheral equipment control only)
- [Function] After reading response data (Xx+3 to Xx+6), the host inverts this signal for notification to the servo amplifier module.
- [Operation] The host exclusive-ORs ABSWT with ABSRD. If the result of exclusive-OR is 1, the host reads response data (Xx+3 to Xx+6), and inverts this signal.

Response data check signals DSP1, DSP2

- [Classification] Input signal <Xx+2#4 to #5> (peripheral equipment control only)
- [Function] The servo amplifier module indicates the contents of response data.
- [Input condition] The servo amplifier module sets the contents of data being output in the response data by using a combination of signals as indicated in the table below.

DSP2	DSP1	Response data
0	0	Not output
1	1	Coordinates, motor current value, skip measurement data, or torque command
1	0	Current position number (ATC, point number)
0	1	Actual feedrate or actual rotation speed

NOTE

- 1 The setting of parameter No. 20 determines which of coordinates, motor current value, skip measurement data, and torque command the response data is.
- 2 The setting of parameter No. 20 determines which of actual feedrate and actual speed the response data is.

3.8.4 Parameter

No	#7	#6	#5	#4	#3	#2	#1	#0
005	ABSPS	LDM						

[Size] 1 byte (bit type)
 [Standard value] 0

ABSPS With the response data read function, the host and servo amplifier module are:
 0 : Not synchronized.
 1 : Synchronized. (Even during movement on axes, the host can read correct position data.)

LDM Motor current value output in response data (Xx+3 to Xx+6) is:
 0 : Disabled.
 1 : Enabled.

No	Specification of the contents of response data (PHOUT)
020	

[Size] 1 byte
 [Standard value] 3

PHOUT As response data (Xx+3 to Xx+6):
 0 : No data is output.
 1 : ATC or point number data is output.
 In the case of ATC cycle or point positioning:
 2 : Machine coordinates are output in real time.
 3 : Workpiece coordinates are output in real time.
 4 : A motor current value is output. The motor current value 6554 represents the maximum current value of the servo amplifier module.
 5 : Measurement data (workpiece coordinates) obtained when a skip signal is input is output.
 6 : An actual feedrate is output in real time.
 [Unit of data] 10^N User-specified unit/MIN (N:Parameter No. 021)
 7 : An actual speed is output in real time.
 [Unit of data] min^{-1}
 8 : A torque command is output in real time. The maximum value of a torque command is 6554.
 The least significant bit is a signal indicating whether the torque limit is reached.
 Least significant bit =
 0 : The torque limit is not reached.
 1 : The torque limit is reached.

NOTE

- 1 For output of a motor current value as response data, set bit 6 (LDM) of parameter No. 0005 to 1, and set parameter No. 0020 to 4.
- 2 When bit 5 of parameter No. 007 is 1 (a turret/magazine number is always output to response data), set this parameter to 1.
- 3 The value of an actual speed is output with a sign. While the motor is being stopped, the motor current may drift, causing the sign to be unstable.

3.8.5 Notes

- 1 This function is enabled only when bit 7 (ABSPTS) of parameter No. 0005 is set to 1.
- 2 This function can be used only with the peripheral equipment control interface. When this function is used, the direct command interface cannot be used.
- 3 When synchronous processing is being performed with this function, the setting of bit 7 (ABSPTS) of parameter No. 0005 cannot be modified.
- 4 The ATC and point numbers are not updated until the end of a command. As for the ATC number, however, it is possible to read constantly updated response data as described in Section 3.9, "Improvement of Turret/Magazine Number Output".
- 5 Information is not updated real-time and, therefore, the function cannot be used for such purposes as the position switch, which must monitor the position constantly. (Response data based on the position at the time when the logic of ABSWT (Xx+1#0) is inverted is retained, and is not updated the next time the logic of ABSWT is inverted.)
- 6 When reading response data using ABSWT (Xx+1#0) and ABSRD (Yy+1#4), note that there are variations of up to about 40 ms in the transfer between the host and the servo amplifier module. The variation maximum may be greater depending on how the ladder program is created.
- 7 If turning on the alarm output command signal DSAL (Yy+0#3) when using this function, turn it on at least 2 msec. before the response data read completion signal ABSRD is inverted. A timing chart is given below.

(Timing chart)

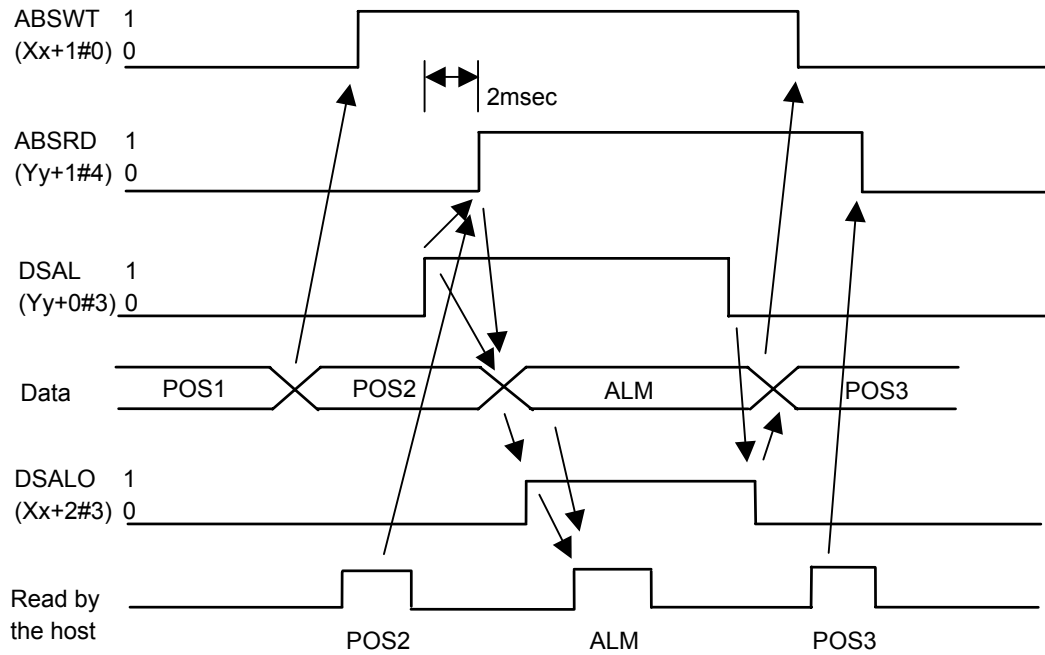

- 8 Refrain from conducting parameter rewriting frequently because there is a limit on the number of times data can be written to EEPROM (memory for retaining parameters) (several tens of thousands of times). If it is necessary to conduct parameter rewriting frequently, set bit 3 (NEPRM) of parameter No. 004 to "1". In this case, rewritten parameters will not be retained after the power is turned off.

3.9 IMPROVEMENT OF TURRET/MAGAZINE NUMBER OUTPUT

3.9.1 Overview

ATC/turret control of peripheral equipment control allows output of the turret/magazine number in response data. In the past, however, the turret/magazine number based on the current position was not output until ATC/turret control was issued after the power was turned on or if the control was interrupted.

Because of this improvement, the turret/magazine number based on the current position is constantly output including the above cases.

3.9.2 Details of Function

The turret/magazine number to be output in response data is improved as described below.

- (1) The turret/magazine number based on the current position is constantly output.
 - It is constantly output, even until ATC/turret control is issued after the power is turned on and if ATC/turret control is interrupted.
 - The nearest turret/magazine number is output even if the current position is not a magazine position. For example, if one rotation about the rotation axis is by "360°" and the number of magazine/turret numbers (parameter No. 068) is "4", the turret/magazine number is output as shown in Fig. 3.9.2 (a).

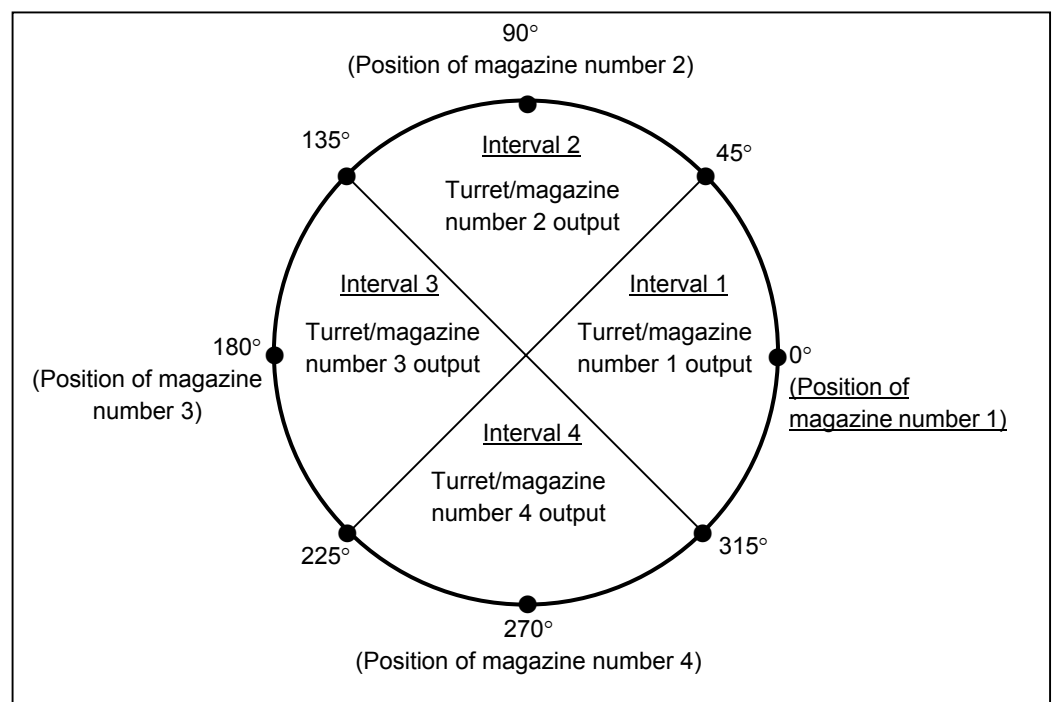

Fig. 3.9.2 (a) Turret/Magazine Number Output Example

Interval 1 ($315^\circ \leq \text{Current position} < 45^\circ$) → Turret/magazine number 1
 Interval 2 ($45^\circ \leq \text{Current position} < 135^\circ$) → Turret/magazine number 2
 Interval 3 ($135^\circ \leq \text{Current position} < 225^\circ$) → Turret/magazine number 3
 Interval 4 ($225^\circ \leq \text{Current position} < 315^\circ$) → Turret/magazine number 4

- A magazine number boundary is regarded as the midpoint between two adjacent magazines. If the current position is on a boundary, the magazine number on the + side is output.
- That the number is constantly output does not mean that response data is automatically updated; response data needs to be read in synchronization with the host. Before reading response data, use ABSWT ($X_{x+1}\#0$) and ABSRD ($Y_{y+1}\#4$) to update the response data. For details of how to do this, see Section 3.8, "Upgrading of the Response Data Read Function".

(2) A signal reports on whether the current position is in the permissible magazine position range.

<1> If the current position is in the permissible magazine position range
 → MINP signal ($X_{x+6}\#7$) output
 <2> If the current position is not in the permissible magazine position range
 → If it out of the permissible range in the + direction → +MOR signal ($X_{x+6}\#6$) output
 → If it is out of the permissible range in the direction → -MOR signal ($X_{x+6}\#5$) output

- For example, if one rotation about the rotation axis is by "360°" and the number of magazine/turret numbers (parameter No. 068) is "4", each signal is output as shown in Fig. 2.

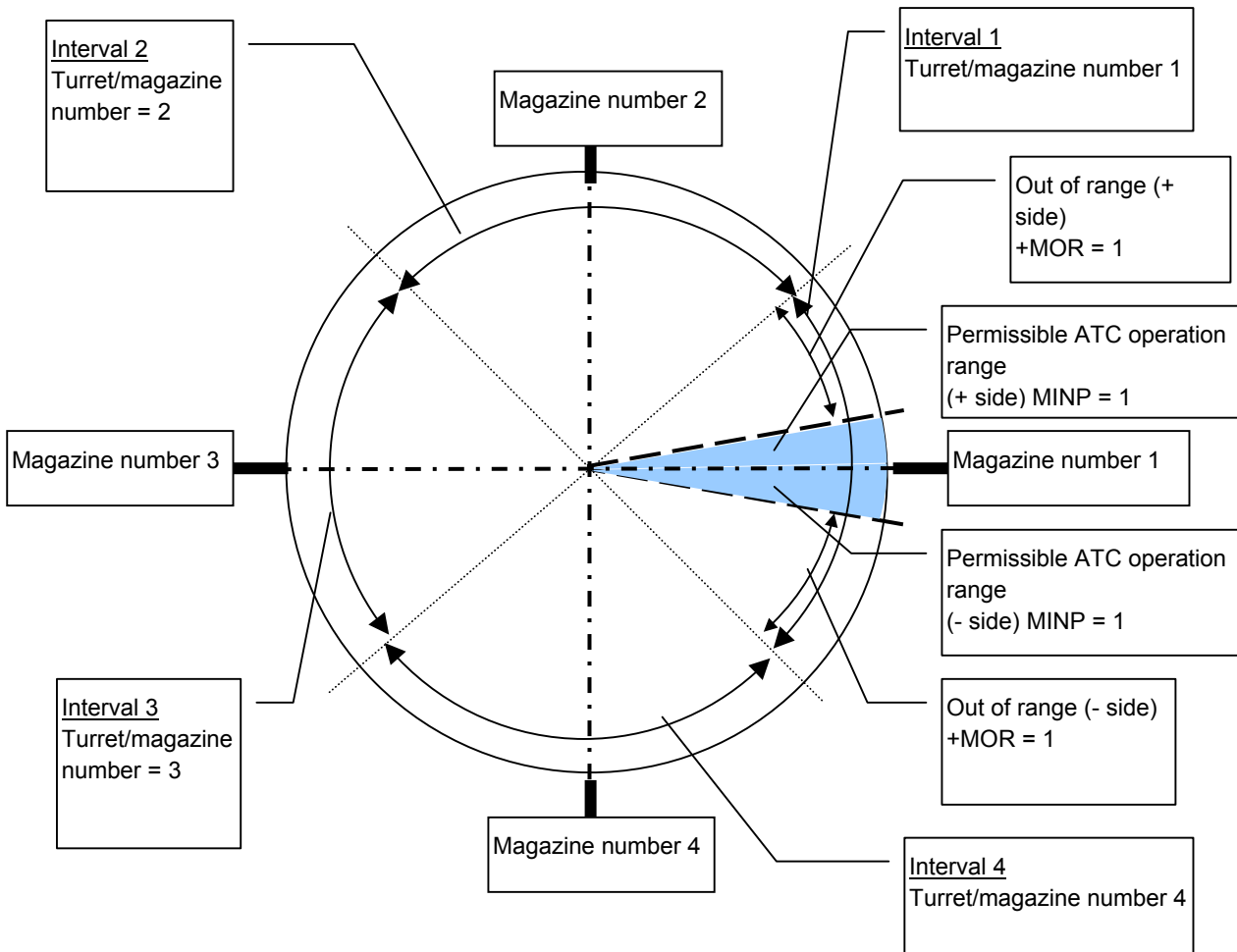

Fig. 3.9.2 (b) MINP, +MOR, and -MOR Signal Output Example

- The following explanation assumes that the current position is in interval 1.
 - When the current position is in the permissible range (the gray portion in Fig. 2) set in the permissible index point value (parameter No. 170) from the magazine position, the MINP signal ($X_{X+6\#7}$) becomes "1" as well as the turret/magazine number.
 - When it is out of the permissible magazine range in the + direction, the +MOR signal ($X_{X+6\#6}$) becomes "1" as well as the turret/magazine number. When it is out of the range in the - direction, the -MOR signal ($X_{X+6\#5}$) becomes "1".
 - Even if the current position is in another interval, the MINP, +MOR, and -MOR signal output conditions are the same; only the turret/magazine number differs.
- For the MINP, +MOR, -MOR signals, response data must be updated using ABSWT ($X_{X+1\#0}$) and ABSRD ($Y_{Y+1\#4}$) before reading the response data, as with the turret/magazine number.

⚠ CAUTION

This improvement is intended for ATC/turret control, and is not applied to point positioning with function code 3. Response data is also output if point positioning is performed, but it does not contain the point number but the turret/magazine number based on the current position. Also, the MINP, +MOR, and -MOR signals are not those corresponding to the point number but corresponding to the turret/magazine number. Also note that the response data output if another function code is issued contains the turret/magazine number and the MINP, +MOR, and -MOR signals based on the current position.

NOTE

- 1 Information is not updated real-time and, therefore, the function cannot be used for such purposes as the position switch, which must monitor the position constantly. (Response data based on the position at the time when the logic of ABSWT ($X_{x+1}\#0$) is inverted is retained, and is not updated the next time the logic of ABSWT is inverted.)
- 2 When reading response data using ABSWT ($X_{x+1}\#0$) and ABSRD ($Y_{y+1}\#4$), note that there are variations of up to 40 ms in the transfer between the host and the servo amplifier module. If, therefore, response data is read during axis movement, the response data may not match the current turret/magazine number and the MINP, +MOR, and -MOR signals because of the variations. The variation maximum may be greater depending on how the ladder program is created.
- 3 Even if, after the power is turned on, response data is read using ABSWT ($X_{x+1}\#0$) an ABSRD ($Y_{y+1}\#4$) before performing ATC/turret control, the turret/magazine number and the MINP, +MOR, -MOR signals based on the current position are output.
- 4 If the current position is near a magazine number boundary, the turret/magazine number may fluctuate if the motor fluctuates.
- 5 For compatibility with conventional types, bit 5 (ATCR2) of parameter No. 007 must be set to "1" to use this improved type.
- 6 No response data is output until the reference position is established. If bit 2 (NZRPO) of parameter No. 007 is set to "1", however, response data is output even if the reference position is not established.

3.9.3 Signal

When the setting is such that the ATC and point numbers are output in response data (parameter No. 020 = 1), the following response data is output in this improved type:

	7	6	5	4	3	2	1	0
Xx+3	Turret/magazine number							
Xx+4	Turret/magazine number							
Xx+5	Reserved							
Xx+6	MINP	+MOR	-MOR					

Response data (turret/magazine number)

- [Classification] Input signal <Xx+3, Xx+4>
 [Function] The nearest turret/magazine number is constantly output.

NOTE

- 1 Because response data must be read by accomplishing synchronization, response data based on the position at the time when the logic of ABSWT ($X_{x+1}\#0$) is inverted is retained, and is not updated the next time the logic of ABSWT is inverted.
- 2 No response data is output until the reference position is established. If bit 2 (NZRPO) of parameter No. 007 is set to "1", however, response data is output even if the reference position is not established.

MINP

- [Classification] Input signal <Xx+6#7>
 [Function] This signal notifies that the current position is in the permissible magazine range.
 [Input condition] The signal becomes 1 when:
1. The current position is in the permissible magazine range. The next ATC operation is possible.
- The signal becomes 0 when:
1. The current position is out of the permissible magazine range. The next ATC operation is not possible.

+MOR

- [Classification] Input signal <Xx+6#6>
 [Function] This signal notifies that the current position is out of the permissible magazine range in the + direction.
 [Input condition] The signal becomes 1 when:
1. The current position is out of the permissible magazine range in the + direction.

The signal becomes 0 when:

1. The current position is in the permissible magazine range. Or, it is out of the permissible range in the - direction.

-MOR

[Classification] Input signal <Xx+6#5>

[Function] This signal notifies that the current position is out of the permissible magazine range in the - direction.

[Input condition] The signal becomes 1 when:

1. The current position is out of the permissible magazine range in the - direction.

The signal becomes 0 when:

1. The current position is in the permissible magazine range. Or, it is out of the permissible range in the + direction.

3.9.4 Parameter

No	#7	#6	#5	#4	#3	#2	#1	#0
007			ATCR2					

[Size] 1 byte (bit type)
 [Standard setting value] 0

- ATCR2 Specifies when to output a turret/magazine number, as follows:
- 0 : A turret/magazine number is output when ATC/turret control is performed. (Conventional method)
 - 1 : A turret/magazine number is always output. (New method)

CAUTION

In the new method, even if a function code for other than ATC/turret control (function code 2) is specified, the turret/magazine number and MINP, +MOR, and -MOR signals corresponding to the current position are always output to response data. Note that, for example, if point positioning is performed, a point number and the MINP, +MOR, and -MOR signals corresponding to the point number are not output to response data.

NOTE

- 1 To enable the new method, the following conditions must also be satisfied.
 - Set parameters as described below to enable ATC/turret control (function code 2).
 - Select a rotation axis (bit 1 of parameter No.000 is 1).
 - Enable the roll-over function (bit 7 of parameter No.000 is 1).
 - Set the number of magazines/turrets (parameter No. 068).
 - Set an index point tolerance (parameter No. 170).
 - Set parameter No.020 to 1 (an ATC and point number are output to response data).
 - Set bit 7 of parameter No.005 to 1 (the host and a servo amplifier module are synchronized with each other in the response data read function).
- 2 In the new method, response data must be read in a synchronous manner. The response data retained is thus based on a position when the logic of ABSWT (XX+1#0) is reversed, and the data is not updated until the next time the ABSWT logic is reversed.
- 3 No response data is output until the reference position is established. If bit 2 (NZRPO) of parameter No. 007 is set to "1", however, response data is output even if the reference position is not established.

3.9.4.1 Related parameters

No	#7	#6	#5	#4	#3	#2	#1	#0
005	ABSPS							

[Size] 1 byte (bit type)

[Standard setting value] 0

ABSPS Specifies whether the host and a servo amplifier module are to be synchronized with each other in the response data read function, as follows:

0 : Not synchronized.

1 : Synchronized. (This makes it possible for the host to read the correct position even during axis movement.)

NOTE

- 1 For details, see Part II, Section 3.8, "Upgrading the Response Data Read Function."
- 2 This parameter is also valid when bit 5 of parameter No. 007 is 1 (a turret/magazine number is always output to response data).

No	#7	#6	#5	#4	#3	#2	#1	#0
007						NZRPO		

[Size] 1 byte (bit type)

[Standard setting value] 0

NZRPO Specifies whether to output a turret/magazine number or point number when ATC/turret control or point positioning control is performed, if a reference position is not established, as follows:

0 : Not output.

1 : Output.

⚠ CAUTION

When an incremental pulse coder is used with bit 2 (NZRPO) of parameter No. 007 set to 1, be sure to set a coordinate system to establish a relationship between the machine and absolute coordinates, before performing ATC operation or point positioning. If ATC operation or point positioning is performed before a coordinate system is set, positioning to correct machine positions may not occur. A turret/magazine number or point number that is then output may not be correct. This affects all types of positioning, not only ATC operation and point positioning.

NOTE

- 1 This parameter is valid when parameter No. 020 is set to 1.
- 2 This parameter is also valid when bit 5 of parameter No. 007 is 1 (a turret/magazine number is always output to response data).

No	Response data specification (PHOUT)
020	
[Size]	1 byte
[Standard setting value]	3
PHOUT	<p>Specifies whether or what to output as response data (Xx+3 to Xx+6), as follows:</p> <p>0 : Nothing is output.</p> <p>1 : An ATC and point No. are output if an ATC cycle and point positioning are involved.</p> <p>2 : Machine coordinates are output in real time.</p> <p>3 : Workpiece coordinates are output in real time.</p> <p>4 : The motor current value is output. The motor current value is 6554, which is the maximum current value for the amplifier.</p> <p>5 : Measurement data (workpiece coordinates) obtained when a skip signal is input is output.</p> <p>6 : An actual feedrate is output in real time. [Unit of data] 10^NUser-specified unit/MIN (N:Parameter No. 021)</p> <p>7 : An actual speed is output in real time. [Unit of data] min^{-1}</p> <p>8 : A torque command is output in real time. The maximum value of a torque command is 6554. The least significant bit is a signal indicating whether the torque limit is reached. Least significant bit =</p> <p>0: The torque limit is not reached.</p> <p>1: The torque limit is reached.</p>

NOTE

- 1 If the motor current value is output as response data, set LDM (bit 6 of parameter No. 005) to "1" and set "4" for parameter No. 020.
- 2 This parameter is also valid when bit 5 of parameter No. 007 is 1 (a turret/magazine number is always output to response data).
- 3 The value of an actual speed is output with a sign. While the motor is being stopped, the motor current may drift, causing the sign to be unstable.

	No	
	170	Index point tolerance
[Size]		4-byte
[Unit of data]		User-specified unit
[Valid data range]		0 to 99999999
[Standard value]		0
[Description]		<p>When the 1-pitch rotation of ATC/turret control is specified, the index point is preserved if the machine deviates from the index point during clamping/ unclamping, as long as the absolute value for the movement amount is equal to or less than this value. For example, when the machine is to move from index point 1 to 2, it can move to the position of point 2 even if it has deviated from the position of point 1 in the direction opposite from the direction of movement, as long as the movement amount is within the value specified in this parameter.</p> <p>In ATC/turret control, this parameter is also used to specify a tolerable magazine range when a turret/magazine number is always output to response data.</p>

NOTE

When bit 5 of parameter No.007 is 1 (a turret/magazine number is always output to response data), set a tolerable magazine range in this parameter.

3.10 MANUAL HANDLE INTERFACE

3.10.1 Overview

This function enables the manual handle feed of a servo amplifier module using the manual pulse generator on the host. The pulses of the manual pulse generator are reported from the host to the servo amplifier module via the I/O Link. Through appropriate parameter switching, it is possible to multiply the pulse output signal of the manual pulse generator. This function can be used in the peripheral equipment control interface only.

This function is an option function on the host.

3.10.2 Details of Function

The host, after selecting the manual handle mode of the servo amplifier module ($MD1(Yy+0\#0)=0$, $MD2(Yy+0\#1)=0$, $MD4(Yy+0\#2)=1$), reports the magnification for the manual pulse generator ($MP1(Yy+7\#4)$, $MP2(Yy+7\#5)$) to the servo amplifier module, to change the manual handle counter.

The servo amplifier module drives the motor by reading only changes in the manual handle counter.

[Timing chart]

(H: Processing on the host

β i: Processing on the servo amplifier module)

H: Manual handle mode

$MD1/2 = 0$

$MD4 = 1$

H: Manual handle magnification
($MP1/2$)

Manual handle counter

β i: Motor drive

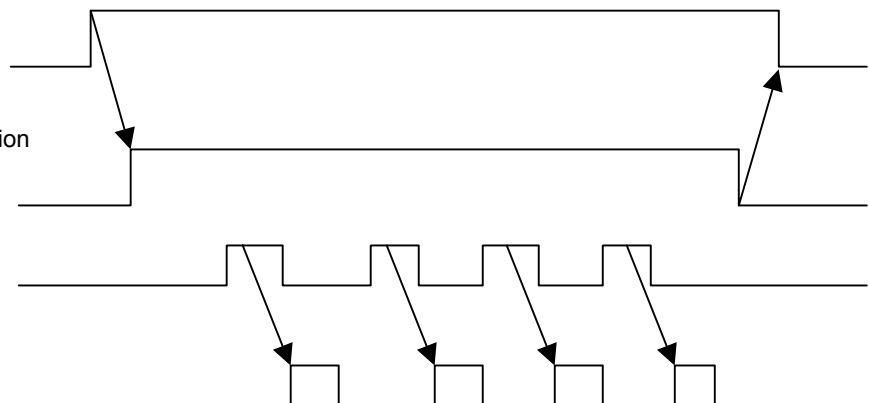

3.10.3 Signal

3.10.3.1 Signal on the servo amplifier module

	7	6	5	4	3	2	1	0
Yy+0						MD4	MD2	MD1
Yy+7			MP2	MP1				

Mode select signals MD1, MD2, and MD4

- [Classification] Output signal <Yy+0#0 to #2>
 [Function] These signals are used to select an operation mode.
 [Operation] These signals are used to select the manual handle feed of the servo amplifier module.

MD1	MD2	MD4	Remarks
0	0	1	Manual handle feed (HANDLE)

NOTE

- 1 Enter manual handle mode before rotating the manual pulse generator.
- 2 Do not switch modes during the manual handle operation of the servo amplifier module.

Incremental feed signal MP1 and MP2

- [Classification] Output signal <Yy+7#4,#5>
 [Function] These signals are used to select a magnification for the manual handle feed of the servo amplifier module.
 [Operation] In manual handle mode, the servo amplifier module drives the motor for the input pulses of the manual pulse generator times the magnification selected with these signals.

MP1	MP2	Amount of travel per graduation of the manual pulse generator
0	0	1 user unit
0	1	10 user units
1	0	100 user units
1	1	(M/N) user units (M = Parameter No. 62, N = Parameter No. 63)

NOTE

- 1 This signal is effective if bit 5 (MP) of parameter No. 5 of the servo amplifier module is 1.
- 2 This signal is effective in manual handle mode only.
- 3 This signal shares the same bits with the rapid traverse override signal. In manual handle mode, these bits are for the incremental feed signal; in modes other than manual handle mode, they are for the rapid traverse override signal. Before switching from manual handle mode to another mode, this signal must be returned to such a setting that the bits are for the rapid traverse override signal.

3.10.3.2 Signal on the CNC (host)

	7	6	5	4	3	2	1	0
G199							IOLBH3	IOLBH2

Manual handle feed generator select signals IOLBH2 and IOLBH3

- [Classification] Input signal <G199#0,#1>
- [Function] These signals are used to select the manual pulse generator used to feed the servo amplifier module.
- [Operation] These signals are used to select the manual pulse generator used to feed the servo amplifier module.

IOLBH3	IOLBH2	Manual pulse generator used to feed the servo amplifier module
0	0	1st
0	1	2nd
1	0	3rd
1	1	Not for use

NOTE

- 1 Do not switch manual pulse generators in manual handle mode.
- 2 Up to two generators can be selected if the manual pulse generator interface is the connector (JA47) on the base PCB on Power Mate *i*-D/H.

3.10.4 Parameter

3.10.4.1 Parameter on the servo amplifier module

No	#7	#6	#5	#4	#3	#2	#1	#0
005			MP	IOH				

[Size] 1 byte (bit type)
 [Standard setting value] 0

IOH Specifies whether to enable manual handle feed over the I/O Link, as follows:
 0 : Disabled.
 1 : Enabled.

NOTE

When this parameter is set to 1, bit 6 (EXPLS) of parameter No. 003 must be set to 0.

MP Specifies whether to enable setting of a magnification in 4 steps with the MP1/MP2 signal for input manual handle pulses for manual handle feed, as follows:
 0 : Disabled.
 1 : Enabled.

3.10.4.2 Parameter on the CNC (host)

No	#7	#6	#5	#4	#3	#2	#1	#0
7103				IOLBH				

[Size] 1 byte (bit type)

IOLBH The manual handle feed to the servo amplifier module, using the I/O Link manual pulse generator is:
 0 : Disabled.
 1 : Enabled.

NOTE

On Power Mate *i*-D/H, the following two types of manual pulse generator interface can be selected with the setting of bit 0 (IOL) of parameter No. 7101:
 IOL = 0: Connector (JA47) on the base PCB
 IOL = 1: I/O link

4

DIRECT COMMANDS

4.1 DIRECT COMMAND FORMAT

The servo amplifier module receives a command issued in the specified format from the host, then executes the command. After command execution, the servo amplifier module returns the result of command execution to the host. Such commands are called direct commands. These commands are set in an interface area in the formats shown below.

- General format of instruction commands (host → servo amplifier module)

	7	6	5	4	3	2	1	0
Yy+4	Control flag 1							
Yy+5	Function code							
Yy+6	Command data 1							
Yy+7	Command data 2							
Yy+8	Command data 3							
:	:							
:	:							
Yy+15	Command data 10							

- General format of response commands (servo amplifier module → host)

	7	6	5	4	3	2	1	0
Xx+4	Control flag 2							
Xx+5	Function code (same as that in the instruction command)							
Xx+6	Reserved				Execution result			
Xx+7	Response data 1							
Xx+8	Response data 2							
Xx+9	Response data 3							
:	:							
:	:							
Xx+15	Response data 9							
Xx+6								

- Data types

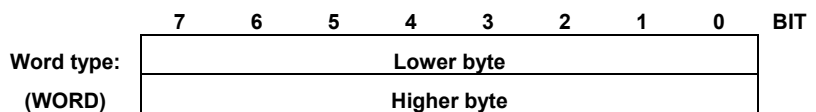
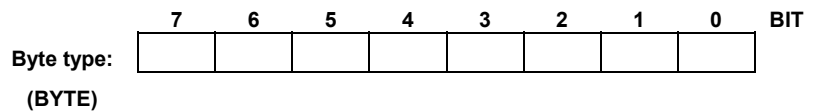

Data = (higher byte)*256 + (lower byte)

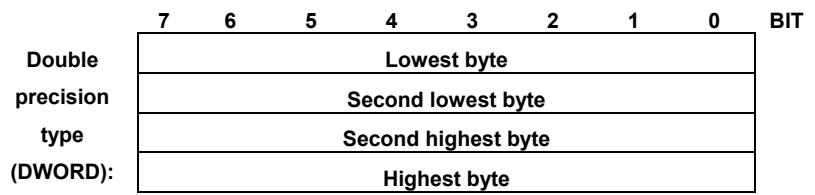

$$\begin{aligned} \text{Data} &= (\text{highest byte}) * 16777216 \\ &+ (\text{second highest byte}) * 65536 \\ &+ (\text{second lowest byte}) * 256 \\ &+ (\text{lowest byte}) \end{aligned}$$

4.2 DIRECT COMMAND CONTROL PROCEDURE

4.2.1 Direct Command Control Procedure

Direct commands are classified into two types: instruction commands which are sent from the host to a servo amplifier module, and response commands which are returned from a servo amplifier module to the host. Such command transfer is controlled using two flags, control flag 1 and control flag 2. Control flag 1 is sent from the host to a servo amplifier module. Control flag 2 is returned from a servo amplifier module to the host.

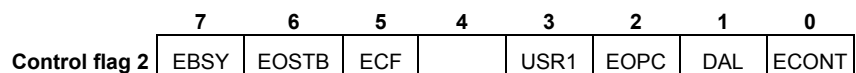
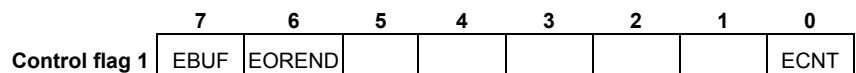

CAUTION

When the power mate CNC manager function is used, control flag 2 transfers data using the same area as that used by the power mate CNC manager function, simultaneously as the function. If the USR1 signal is 0, control flag 2 is for the ladder. If the USR1 signal is 1, control flag 2 is for the power mate CNC manager and, therefore, must be ignored.

NOTE

- 1 Clamping/unclamping of peripheral equipment control cannot be used. Be sure to set bit 1 (NCLP) of parameter No. 003 to "1".
- 2 To perform jog operation, select jog (JOG) mode and start it with a feed axis direction select signal (+X or -X). The override signals (*OV1 to *OV8) and the manual rapid traverse select signal (RT) can also be used.

4.2.2 Instruction Command Control (EBUF, EBSY, and ECNT)

Instruction commands sent from the host to a servo amplifier module are controlled with EBUF and EBSY.

When the EBUF and EBSY states (values) match, the host can write a command into the interface area. After writing the command, the host inverts EBUF.

If the EBUF and EBSY states differ, the servo amplifier module assumes that a new command has been specified.

Therefore, control flag 1 must be written last after a function number and command data are written. After the servo amplifier module reads the command, it inverts the EBSY state.

EBUF is initially set to 0.

Since the instruction command data area is limited, instruction command data sometimes cannot be sent if the amount of data is excessive. In such a case, more than one instruction command must be issued to send all the data. If there is an additional instruction command to be sent, ECNT is set to 1 to indicate that another command follows.

NOTE

When the power mate CNC manager function is used, the inverted EBSY state is posted to the host for 40 ms. This duration can be changed by parameter setting (parameter No. 0022).

4.2.3 Response Command Control (EOREND, EOSTB, EOPC, USR1, and ECONT)

Response commands returned from the servo amplifier module are controlled with EOREND, EOSTB, and EOPC. EOPC indicates that the response command is in continuous read mode.

The host reads response data according to the following control procedure:

When the EOREND state and EOSTB state do not match, the host can read response data. After reading the data, the host inverts EOREND such that the EOREND state matches the EOSTB state. As EOREND is inverted, the servo amplifier module regards the data read operation as having been completed.

When the amount of data in a response command is too great to enable the sending of all the data at one time, ECONT indicates 1. In this case, after reading the current data, the host inverts EOREND such that it matches the EOSTB state, then waits for the next data. The host must read the data repeatedly until ECONT becomes 0. Note that the next data (continuous data) is output from Xx+5 (function code address).

 **CAUTION**

When the power mate CNC manager function is used, the area used by the power mate CNC manager function is also used simultaneously by the direct commands of the PMC ladder program to exchange the data. USR1 being set to 0 indicates that the data in the area is a response to the ladder program, so read processing must be performed. USR1 being set to 1 indicates that data in the area is a response to the power mate CNC manager and is to be ignored.

4.2.4 Command Completion Notification (ECF)

When NMOD is set to 1 for an instruction command, the command is executed in completion notification mode. This means that the servo amplifier module notifies the host that execution of the instruction command has been completed, and the servo amplifier module does not execute the next command until the servo amplifier unit receives a response from the host.

- (1) Upon the completion of command execution, the servo amplifier module sets ECF to 1.
- (2) The host issues the FIN instruction command to notify the servo amplifier module that the host has received completion notification.

NOTE

When the power mate CNC manager function is used, ECF being set to 1 is posted to the host for 40 ms. This duration can be changed by parameter setting (parameter No. 0022).

4.2.5 Alarm (DAL)

If an alarm is issued in the servo amplifier module, DAL is set to 1. When detailed information about the alarm is required, the host specifies the READ ALARM STATUS command.

4.2.6 Direct Command Execution Result

The servo amplifier module returns the result of execution using the following code. Upon the reception of an execution result, the host performs appropriate processing such as error display and retry operation.

Completion code	Meaning	Description (action)
0	Normal termination	
1	Execution error	Execution was attempted with no program. Start of execution was attempted during execution.
2	Data length error	Direct command has an illegal command format.
3	Incorrect number of data items	Direct command has an illegal command format.
4	Data attribute error	Direct command has an illegal command format.
7	Write protect error	
8	Memory overflow	
9	Parameter error	An illegal parameter is set.
10	Buffer control error	
12	Mode select error	
14	Reset or halted	
15	Execution in progress	

4.3 LIST OF DIRECT COMMANDS

Function	Function code	Reference item
1. Signal operation commands		
(1) Setting and releasing the torque limit enable signal	0x0C	4.4.1 (1)
(2) Specifying the torque limit value	0x91	4.4.1 (2)
2. Parameters		
(1) Reading parameters	0x20	4.4.2 (1)
(2) Writing parameters	0x21	4.4.2 (2)
3. Status read		
(1) Reading the absolute position	0x30	4.4.3 (1)
(2) Reading the machine position	0x31	4.4.3 (2)
(3) Reading skip measurement data	0x32	4.4.3 (3)
(4) Reading the servo positional deviation	0x33	4.4.3 (4)
(5) Reading the acceleration/deceleration delay	0x34	4.4.3 (5)
(6) Reading the actual feedrate	0x36	4.4.3 (6)
(7) Reading the status	0x37	4.4.3 (7)
(8) Reading alarm information	0x38	4.4.3 (8)
(9) Reading the series and edition of system software	0x3F	4.4.3 (9)
(10) Reading data continuously	0x41	4.4.3 (10)
(11) Reading the motor current value	0x95	4.4.3 (11)
(12) Reading the torque command	0x96	4.4.3 (12)
(13) Reading the actual speed	0x97	4.4.3 (13)
4. Axis movement commands		
(1) Reference position return	0x60	4.4.4 (1)
(2) Absolute positioning	0x61	4.4.4 (2)
(3) Incremental positioning	0x62	4.4.4 (3)
(4) Dwell	0x63	4.4.4 (4)
(5) Coordinate system setting	0x64	4.4.4 (5)
(6) Acquiring the FIN state	0x66	4.4.4 (6)
(7) FIN command	0x67	4.4.4 (7)
(8) Speed control	0x6F	4.4.4 (8)
(9) Wait command	0x90	4.4.4 (9)

4.4 DETAILS OF DIRECT COMMAND FUNCTIONS

4.4.1 Signal Operation Commands

- (1) Setting and releasing the torque limit enable signal
The host specifies the setting and release of the torque limit enable signal.

- Instruction command format

	#7	#6	#5	#4	#3	#2	#1	#0	
Yy+4	Control flag 1								
Yy+5	0	0	0	0	1	1	0	0	(0x0C)
Yy+6	0	0	0	1	0	0	0	SET	

SET = 0 : Releases the torque limit enable signal.

SET = 1 : Sets the torque limit enable signal.

- Response command format
This command has no response data.
It only inverts EBSY.

- (2) Specifying the torque limit value
The host specifies the torque limit value when the torque limit is enabled.

- Instruction command format

	#7	#6	#5	#4	#3	#2	#1	#0	
Yy+4	Control flag 1								
Yy+5	1	0	0	1	0	0	0	1	(0x91)
Yy+6	0	0	0	1	0	0	0	0	
Yy+7	Torque limit value								
Yy+8	Torque limit value								

Torque limit value : 0 to 7282

Setting value = Torque limit value [%] × (7282/100)

- Response command format
This command has no response data.
It only inverts EBSY.

NOTE

- 1 Set bit 2 (IEBL) of parameter No. 0010 to "1" to enable the torque limit function.
- 2 After the release command, the system returns to the torque limit value set in parameter No. 108.
- 3 A torque limit value of 0 means 100% (disabled).

4.4.2 Parameter

(1) Reading parameters

The host can read parameters for the servo amplifier module.

- Instruction command format

	#7	#6	#5	#4	#3	#2	#1	#0	
Yy+4	Control flag 1								(0x20)
Yy+5	0	0	1	0	0	0	0	0	
Yy+6	Parameter No. (Word type)								
Yy+7									

- Response command format

Byte type

	#7	#6	#5	#4	#3	#2	#1	#0	
Xx+4	Control flag 2								(0x20)
Xx+5	0	0	1	0	0	0	0	0	
Xx+6	Reserved				Execution result				
Xx+7	Data length (Byte type) = 1								
Xx+8	Parameter (Byte type)								

Word type

	#7	#6	#5	#4	#3	#2	#1	#0	
Xx+4	Control flag 2								(0x20)
Xx+5	0	0	1	0	0	0	0	0	
Xx+6	Reserved				Execution result				
Xx+7	Data length (Byte type) = 2								
Xx+8	Parameter (Word type)								
Xx+9									

DWORD type

	#7	#6	#5	#4	#3	#2	#1	#0	
Xx+4	Control flag 2								(0x20)
Xx+5	0	0	1	0	0	0	0	0	
Xx+6	Reserved				Execution result				
Xx+7	Data length (Byte type) = 4								
Xx+8	Parameter (DWORD type)								
Xx+9									
Xx+10									
Xx+11									

(2) Writing parameters

The host can write parameters for the servo amplifier module.

⚠ CAUTION

- 1 Writing parameters from the host is prohibited while the servo amplifier unit is operating.
- 2 There is a limit to the number of writes to the memory (EEPROM) in the β amplifier that is used to store parameter settings (tens of thousands of writes).

For this reason, the direct command, parameter rewrite instruction, cannot be used for applications that frequently change parameters. It is, however, possible to frequently change parameters if the parameter setting is such that only the data on the RAM is changed without writes to the EEPROM (NEPRM (bit 3 of parameter No. 004) = 1). If the number of parameter rewrites exceed the limit, any subsequent writes to the memory are prohibited, possibly causing an alarm (LED display: "8").

- Instruction command format

Byte type

	#7	#6	#5	#4	#3	#2	#1	#0	
Yy+4	Control flag 1								
Yy+5	0	0	1	0	0	0	0	1	(0x21)
Yy+6	Parameter No. (Word type)								
Yy+7	Parameter No. (Word type)								
Yy+8	0	0	0	0	0	0	0	1	
Yy+9	Data length (Byte type) = 1								
Yy+10	Parameter (Byte type)								

Word type

	#7	#6	#5	#4	#3	#2	#1	#0	
Yy+4	Control flag 1								
Yy+5	0	0	1	0	0	0	0	1	(0x21)
Yy+6	Parameter No. (Word type)								
Yy+7	Parameter No. (Word type)								
Yy+8	0	0	0	0	0	0	0	1	
Yy+9	Data length (Byte type) = 2								
Yy+10	Parameter (Word type)								
Yy+11	Parameter (Word type)								

DWORD type

	#7	#6	#5	#4	#3	#2	#1	#0	
Yy+4	Control flag 1								(0x21)
Yy+5	0	0	1	0	0	0	0	1	
Yy+6	Parameter No. (Word type)								
Yy+7	Parameter No. (Word type)								
Yy+8	0	0	0	0	0	0	0	1	
Yy+9	Data length (Byte type) = 4								
Yy+10	Parameter (DWORD type)								
Yy+11	Parameter (DWORD type)								
Yy+12	Parameter (DWORD type)								
Yy+13	Parameter (DWORD type)								

- Response command format

	#7	#6	#5	#4	#3	#2	#1	#0	
Xx+4	Control flag 2								(0x21)
Xx+5	0	0	1	0	0	0	0	1	
Xx+6	Reserved				Execution result				

4.4.3 Status Read

- (1) Reading the absolute position
 The host can read the absolute position of the servo amplifier module.

● Instruction command format

	#7	#6	#5	#4	#3	#2	#1	#0	
Yy+4	Control flag 1								(0x30)
Yy+5	0	0	1	1	0	0	0	0	
Yy+6	0	0	0	0	0	0	0	1	

● Response command format

	#7	#6	#5	#4	#3	#2	#1	#0	
Xx+4	Control flag 2								(0x30)
Xx+5	0	0	1	1	0	0	0	0	
Xx+6	Reserved				Execution result				
Xx+7	Absolute position data (DWORD type)								(0x31)
Xx+8									
Xx+9									
Xx+10									

- (2) Reading the machine position
 The host can read the machine position of the servo amplifier module.

● Instruction command format

	#7	#6	#5	#4	#3	#2	#1	#0	
Yy+4	Control flag 1								(0x31)
Yy+5	0	0	1	1	0	0	0	1	
Yy+6	0	0	0	0	0	0	0	1	

● Response command format

	#7	#6	#5	#4	#3	#2	#1	#0	
Xx+4	Control flag 2								(0x31)
Xx+5	0	0	1	1	0	0	0	1	
Xx+6	Reserved				Execution result				
Xx+7	Machine position data (DWORD type)								(0x31)
Xx+8									
Xx+9									
Xx+10									

(3) Reading skip measurement data

This function reads from the host the workpiece coordinates at the time of skip signal input. (This function can be used only when the skip function is enabled (bit 0 (HENB) of parameter No. 017 is 1).

● Instruction command format

	#7	#6	#5	#4	#3	#2	#1	#0	
Yy+4	Control flag 1								
Yy+5	0	0	1	1	0	0	1	0	(0x32)
Yy+6	0	0	0	0	0	0	0	1	

● Response command format

	#7	#6	#5	#4	#3	#2	#1	#0	
Xx+4	Control flag 2								
Xx+5	0	0	1	1	0	0	1	0	(0x32)
Xx+6	Reserved				Execution result				
Xx+7	Skip measurement data (DWORD type)								
Xx+8									
Xx+9									
Xx+10									

(4) Reading the servo positional deviation

This function reads the servo positional deviation of the servo amplifier module from the host.

● Instruction command format

	#7	#6	#5	#4	#3	#2	#1	#0	
Yy+4	Control flag 1								
Yy+5	0	0	1	1	0	0	1	1	(0x33)
Yy+6	0	0	0	0	0	0	0	1	

● Response command format

	#7	#6	#5	#4	#3	#2	#1	#0	
Xx+4	Control flag 2								
Xx+5	0	0	1	1	0	0	1	1	(0x33)
Xx+6	Reserved				Execution result				
Xx+7	Servo positional deviation data (DWORD type)								
Xx+8									
Xx+9									
Xx+10									

- (5) Reading the acceleration/deceleration delay
 The host can read the acceleration/deceleration delay in the servo amplifier module.

● Instruction command format

	#7	#6	#5	#4	#3	#2	#1	#0	
Yy+4	Control flag 1								(0x34)
Yy+5	0	0	1	1	0	1	0	0	
Yy+6	0	0	0	0	0	0	0	1	

● Response command format

	#7	#6	#5	#4	#3	#2	#1	#0	
Xx+4	Control flag 2								(0x34)
Xx+5	0	0	1	1	0	1	0	0	
Xx+6	Reserved				Execution result				
Xx+7	Acceleration/deceleration delay data (DWORD type)								
Xx+8									
Xx+9									
Xx+10									

- (6) Reading the actual feedrate
 The host can read the actual feedrate of the servo amplifier module.

● Instruction command format

	#7	#6	#5	#4	#3	#2	#1	#0	
Yy+4	Control flag 1								(0x36)
Yy+5	0	0	1	1	0	1	1	0	

● Response command format

	#7	#6	#5	#4	#3	#2	#1	#0	
Xx+4	Control flag 2								(0x36)
Xx+5	0	0	1	1	0	1	1	0	
Xx+6	Reserved				Execution result				
Xx+7	Actual feedrate data (DWORD type)								
Xx+8									
Xx+9									
Xx+10									

(7) Reading the status

The host can read the execution status of the servo amplifier module (such as the mode being selected and the alarm state).

● Instruction command format

	#7	#6	#5	#4	#3	#2	#1	#0	
Yy+4	Control flag 1								
Yy+5	0	0	1	1	0	1	1	1	(0x37)

● Response command format

	#7	#6	#5	#4	#3	#2	#1	#0	
Xx+4	Control flag 2								
Xx+5	0	0	1	1	0	1	1	1	(0x37)
Xx+6	Reserved				Execution result				
Xx+7	Operation state				Mode state				
Xx+8	Alarm state				Emergency stop state				
Xx+9	Alarm state				Emergency stop state				

Mode state: 1:AUTO, 4:HANDLE, 5:JOG

Operation state: 0:(reset), 1: STOP, 3:START

Action state: 0:***, 2: Dwelling, 1: Operating

Emergency stop state:
0:***, 2: Reset state, 1: Emergency stop state

Alarm state: 0:***, 2: Battery alarm issued, 1: Alarm issued

(8) Reading alarm information

When an alarm is issued in the servo amplifier module, the host can read the alarm number of the alarm.

Among issued alarm numbers, up to three alarm numbers can be read in ascending order.

● Instruction command format

	#7	#6	#5	#4	#3	#2	#1	#0	
Yy+4	Control flag 1								
Yy+5	0	0	1	1	1	0	0	0	(0x38)
Yy+6	Data size (*1)								

(*1) In "data size", specify the number of alarm numbers to be read x 3. Because up to three numbers can be read, the maximum for "data size" is 9.

● Response command format

	#7	#6	#5	#4	#3	#2	#1	#0	
Xx+4	Control flag 2								
Xx+5	0	0	1	1	1	0	0	0	(0x38)
Xx+6	Reserved				Execution result				
Xx+7	0	0	0	0	0	0	0	0	
Xx+8	Alarm number 1 (Word type)								Not larger than the data size
Xx+9	0								
Xx+10	0	0	0	0	0	0	0	0	
Xx+11	Alarm number 2 (Word type)								Not larger than the data size
Xx+12	0								
								
	1	1	1	1	1	1	1	1	(*2)

(*2) As final data, 0xFF is output.

NOTE

- 1 The data length depends on the data size.
- 2 If ECONT is "1", this indicates that there is remaining response command(s). After the current response command is read, inverting EOREND causes the remaining command to be output from Xx+5. Repeat this operation until ECONT becomes "0".

- (9) Reading the series and edition of system software
The host can read the series and edition of system software.

● Instruction command format

	#7	#6	#5	#4	#3	#2	#1	#0	
Yy+4	Control flag 1								
Yy+5	0	0	1	1	1	1	1	1	(0x3F)

● Response command format

	#7	#6	#5	#4	#3	#2	#1	#0	
Xx+4	Control flag 2								
Xx+5	0	0	1	1	1	1	1	1	(0x3F)
Xx+6	Reserved				Execution result				
Xx+7	Series								
Xx+8									
Xx+9									
Xx+10									
Xx+11	Edition								
Xx+12									
Xx+13									
Xx+14									
Xx+15	Edition								
Xx+16									
Xx+17									
Xx+18									
Xx+19	Edition								
Xx+20									

The edition is output as ASCII codes. The high-order two bytes of the edition is always "0" (ASCII code 0x30). The low-order two bytes is the edition information. For example, if the edition is 08, the following is output:

	#7	#6	#5	#4	#3	#2	#1	#0	
Xx+15	0	0	1	1	0	0	0	0	(0x30)
Xx+16	0	0	1	1	0	0	0	0	(0x30)
Xx+17	0	0	1	1	0	0	0	0	(0x30)
Xx+18	0	0	1	1	1	0	0	0	(0x38)

Two separate response commands are output. The output data of the first response command and that of the second are as follows:

<First response command>

	#7	#6	#5	#4	#3	#2	#1	#0	
Xx+4	Control flag 2								(0x3F)
Xx+5	0	0	1	1	1	1	1	1	
Xx+6	Reserved				Execution result				
Xx+7									
Xx+8									
Xx+9									
Xx+10	Series								
Xx+11									
Xx+12									
Xx+13									
Xx+14	Edition								
Xx+15									

<Second response command>

	#7	#6	#5	#4	#3	#2	#1	#0
Xx+4	Control flag 2							
Xx+5								
Xx+6								
Xx+7								
Xx+8	Edition							
Xx+9								

Thus, the edition is output by a combination of Xx+15 of the first response command and Xx+5 to Xx+7 of the second response command.

(10) Reading data continuously

This function reads from the host the absolute position, machine position, servo positional deviation, etc. of the servo amplifier module continuously.

● Instruction command format

	#7	#6	#5	#4	#3	#2	#1	#0	
Yy+4	Control flag 1								
Yy+5	0	1	0	0	0	0	0	1	(0x41)
Yy+6	Number of data items to be read (*1)								
	Read data specification 1								
	//								
	Read data specification n								

(*1) Up to four data items can be specified for reading. When continuous read operation is canceled, the host sets 0 as the number of data items.

● Response command format

	#7	#6	#5	#4	#3	#2	#1	#0	
Xx+4	Control flag 2								
Xx+5	0	1	0	0	0	0	0	1	(0x41)
Xx+6	Reserved				Execution result				
	Continuously read data 1								
	//								
	Continuously read data n								

NOTE

- 1 The data length varies according to the specified data.
- 2 If a stop command (number of items: 0) is issued, "0x80" is output as a completion code to Xx+6. When this response command is read and EOREND is inverted, continuous data reading ends.
- 3 If ECONT is "1", this indicates that there is remaining response command(s). After the current response command is read, inverting EOREND causes the remaining command to be output from Xx+5. Repeat this operation until ECONT becomes "0".

The types of data to be read continuously are specified using the following codes. The read data format for each code is also shown below.

- (a) Reading the absolute position 0x01
- (b) Reading the machine position 0x02
- (c) Reading the servo positional deviation 0x03
- (d) Reading the acceleration/deceleration delay 0x04
- (e) Reading the actual feedrate 0x05
- (f) Reading the status 0x06
- (g) Reading the motor current value 0x0D
- (h) Reading the torque command 0x0E
- (i) Reading the actual speed 0x0F

- (a) Reading the absolute position 0x01

● Data specification code for continuous read

	#7	#6	#5	#4	#3	#2	#1	#0	
0	0	0	0	0	0	0	0	1	(0x01)
1	0	0	0	0	0	0	0	1	

● Continuous read data format

	#7	#6	#5	#4	#3	#2	#1	#0	
0	0	0	0	0	0	0	0	1	(0x01)
1	Reserved				Execution result				
2	Absolute position data (DWORD type)								
3									
4									
5									

- (b) Reading the machine position 0x02

● Data specification code for continuous read

	#7	#6	#5	#4	#3	#2	#1	#0	
0	0	0	0	0	0	0	1	0	(0x02)
1	0	0	0	0	0	0	0	1	

● Continuous read data format

	#7	#6	#5	#4	#3	#2	#1	#0	
0	0	0	0	0	0	0	1	0	(0x02)
1	Reserved				Execution result				
2	Machine position data (DWORD type)								
3									
4									
5									

(c) Reading the servo positional deviation 0x03

- Data specification code for continuous read

	#7	#6	#5	#4	#3	#2	#1	#0	
0	0	0	0	0	0	0	1	1	(0x03)
1	0	0	0	0	0	0	0	1	

- Continuous read data format

	#7	#6	#5	#4	#3	#2	#1	#0	
0	0	0	0	0	0	0	1	1	(0x03)
1	Reserved				Execution result				
2	Servo positional deviation data (DWORD type)								
3									
4									
5									

(d) Reading the acceleration/deceleration delay 0x04

- Data specification code for continuous read

	#7	#6	#5	#4	#3	#2	#1	#0	
0	0	0	0	0	0	1	0	0	(0x04)
1	0	0	0	0	0	0	0	1	

- Continuous read data format

	#7	#6	#5	#4	#3	#2	#1	#0	
0	0	0	0	0	0	1	0	0	(0x04)
1	Reserved				Execution result				
2	Acceleration/deceleration delay data (DWORD type)								
3									
4									
5									

(e) Reading the actual feedrate 0x05

● Data specification code for continuous read

	#7	#6	#5	#4	#3	#2	#1	#0	
0	0	0	0	0	0	1	0	1	(0x05)
1	0	0	0	0	0	0	0	1	

● Continuous read data format

	#7	#6	#5	#4	#3	#2	#1	#0	
0	0	0	0	0	0	1	0	1	(0x05)
1	Reserved				Execution result				
2	Actual feedrate data (DWORD type) Unit: 10 ^N user units/MIN(N: Parameter No. 021)								
3									
4									
5									

(f) Reading the status of a slave 0x06

● Data specification code for continuous read

	#7	#6	#5	#4	#3	#2	#1	#0	
0	0	0	0	0	0	1	1	0	(0x06)
1	0	0	0	0	0	0	0	1	

● Continuous read data format

	#7	#6	#5	#4	#3	#2	#1	#0	
0	0	0	0	0	0	1	1	0	(0x06)
1	Reserved				Execution result				
2	Operation state				Mode state				
3					Action state				
4	Alarm state				Emergency stop state				

Mode state: 1 AUTO4 HANDLE
5 JOG

Operation state: 0 (reset)
1 STOP 3 START

Action state: 0 *** 2 Dwelling
1 Operating

Emergency stop state: 0 *** 2 Reset state
1 Emergency stop state

Alarm state: 0 *** 2 Battery alarm issued
1 Alarm issued

(g) Reading the motor current value 0x0D

- Data specification code for continuous read

	#7	#6	#5	#4	#3	#2	#1	#0	
0	0	0	0	0	1	1	0	1	(0x0D)
1	0	0	0	0	0	0	0	1	

- Continuous read data format

	#7	#6	#5	#4	#3	#2	#1	#0	
0	0	0	0	0	1	1	0	1	(0x0D)
1	Reserved				Execution result				
2	Motor current value data (DWORD type)								
3									
4									
5									

The motor current value means the maximum current value of the amplifier when it is 6554.

(h) Reading the torque command 0x0E

- Data specification code for continuous read

	#7	#6	#5	#4	#3	#2	#1	#0	
0	0	0	0	0	1	1	1	0	(0x0E)
1	0	0	0	0	0	0	0	1	

- Continuous read data format

	#7	#6	#5	#4	#3	#2	#1	#0	
0	0	0	0	0	1	1	1	0	(0x0E)
1	Reserved				Execution result				
2	Torque command data (DWORD type)								
3									
4									
5									

The maximum value of the torque command is 6554.
The least significant bit of the torque command means the torque limit arrival signal.

The least significant bit of the torque command =
0: The torque limit has not been reached.
1: The torque limit has been reached.

(i) Reading the actual speed 0x0F

● Data specification code for continuous read

	#7	#6	#5	#4	#3	#2	#1	#0	
0	0	0	0	0	1	1	1	1	(0x0F)
1	0	0	0	0	0	0	0	1	

● Continuous read data format

	#7	#6	#5	#4	#3	#2	#1	#0	
0	0	0	0	0	1	1	1	1	(0x0F)
1	Reserved				Execution result				
2	Actual speed data (DWORD type) Unit: min ⁻¹								
3									
4									
5									

(11) Reading the motor current value

This function reads the motor current value from the host.

● Instruction command format

	#7	#6	#5	#4	#3	#2	#1	#0	
Yy+4	Control flag 1								(0x95)
Yy+5	1	0	0	1	0	1	0	1	
Yy+6	0	0	0	0	0	0	0	1	

● Response command format

	#7	#6	#5	#4	#3	#2	#1	#0	
Xx+4	Control flag 2								(0x95)
Xx+5	1	0	0	1	0	1	0	1	
Xx+6	Reserved				Execution result				
Xx+7	Motor current value data (DWORD type)								
Xx+8									
Xx+9									
Xx+10									

The motor current value means the maximum current value of the amplifier when it is 6554.

(12) Reading the torque command

This function reads from the host the torque command of the servo amplifier module.

● Instruction command format

	#7	#6	#5	#4	#3	#2	#1	#0	
Yy+4	Control flag 1								(0x96)
Yy+5	1	0	0	1	0	1	1	0	
Yy+6	0	0	0	0	0	0	0	1	

● Response command format

	#7	#6	#5	#4	#3	#2	#1	#0	
Xx+4	Control flag 2								(0x96)
Xx+5	1	0	0	1	0	1	1	0	
Xx+6	Reserved				Execution result				
Xx+7	Torque command data (DWORD type)								
Xx+8									
Xx+9									
Xx+10									

The maximum value of the torque command is 6554.
 The least significant bit of the torque command means the torque limit arrival signal.
 The least significant bit of the torque command =
 0: The torque limit has not been reached.
 1: The torque limit has been reached.

(13) Reading the actual speed

This function reads from the host the actual speed of the servo amplifier module.

● Instruction command format

	#7	#6	#5	#4	#3	#2	#1	#0	
Yy+4	Control flag 1								(0x97)
Yy+5	1	0	0	1	0	1	1	1	
Yy+6	0	0	0	0	0	0	0	1	

● Response command format

	#7	#6	#5	#4	#3	#2	#1	#0	
Xx+4	Control flag 2								(0x97)
Xx+5	1	0	0	1	0	1	1	1	
Xx+6	Reserved				Execution result				
Xx+7	Actual speed data (DWORD type) Unit of data : min ⁻¹								
Xx+8									
Xx+9									
Xx+10									

4.4.4 Axis Movement Commands

Axis movement commands are executed in AUTO mode.



CAUTION

Do not change the mode during operation. Change the mode only after operation stops.

NOTE

- 1 The command cannot be executed if the alarm signal (AL) is "1".
- 2 Clamping/unclamping of peripheral equipment control cannot be used. Be sure to set bit 1 (NCLP) of parameter No. 003 to "1".

(1) Reference position return

This command instructs the servo amplifier module to perform reference position return.

For reference position return without dogs, when the reference position has not been established, movement is performed at low speed (parameter No. 054) in the reference position return direction (bit 5 (ZMIX) of parameter No. 010) to stop at the first grid position, which is regarded as the reference position. When the reference position has already been established, return to the reference position is performed at high speed (rapid traverse rate). Setting bit 2 (DZRN) of parameter No.011 to "1" causes reference position return with dogs to be enabled. For details, see Section 3.5, "Reference Position Return Function with Dogs".

● Instruction command format

	#7	#6	#5	#4	#3	#2	#1	#0	
Yy+4	Control flag 1								
Yy+5	0	1	1	0	0	0	0	0	(0x60)
Yy+6	0	0	0	0	NMOD	0	0	0	
Yy+7	0	0	0	0	0	0	0	1	

NMOD = 1 : Execution completion notification mode
(For details, see Section 4.2.)

● Response command format

This command has no response data.
It only inverts EBSY.

NOTE

This command can be executed even if alarm 224 has been issued.

(2) Absolute positioning

This command instructs the servo amplifier module to perform absolute positioning.

The motor moves through an amount equal to the difference between a specified absolute position and the current position.

● Instruction command format

	#7	#6	#5	#4	#3	#2	#1	#0	
Yy+4	Control flag 1								
Yy+5	0	1	1	0	0	0	0	1	(0x61)
Yy+6	0	0	0	0	NMOD	0	0	1	
Yy+7	SKIP	RPD	SMZX	0	0	0	0	1	
Yy+8	Feedrate								
Yy+9	Absolute position								
Yy+10									
Yy+11									
Yy+12									
Yy+13									

Feedrate : 1 to 65535 [10^N user-specified unit/MIN]]
(N is set with parameter No. 021.)

Absolute position : -99999999 to 99999999 [user-specified unit]

NMOD = 1 : Execution completion notification mode
(For details, see Section 4.2.)

SMZX = 1 : Performs an in-position check during cutting feed.

<1> If RPD is "0" and SMZX is "1", an in-position check is performed with the in-position width set in parameter No. 137 (when bit 3 (CIPC) of parameter No. 002 = 1) at the end of the command. After the end of the command, confirm whether the motor is in position by checking if the following are true: Distribution pulse signal IPLX ($Xx+0\#1$) = 0, acceleration/deceleration pulse signal SUPX ($Xx+0\#2$) = 0, in-position signal INPX ($Xx+0\#3$) = 1, axis movement signal MVX ($Xx+3\#2$) = 0, and automatic operation start signal STL ($Xx+1\#5$) = 0.

<2> If RPD is "1", an in-position check is performed with the in-position width set in parameter No. 111. After the end of the command, confirm whether the motor is in position by checking if the following are true: Distribution pulse signal IPLX ($Xx+0\#1$) = 0, acceleration/deceleration pulse signal SUPX ($Xx+0\#2$) = 0, in-position signal INPX ($Xx+0\#3$) = 1, axis movement signal MVX ($Xx+3\#2$) = 0, and automatic operation start signal STL ($Xx+1\#5$) = 0.

RPD = 1 : Rapid traverse

SKIP = 1 : Skip function used

If the command is being executed independently when the skip signal (HDI) is input, axis movement is stopped immediately and command execution is ended. If during thirty-two-buffering operation, the currently executed block is skipped to proceed to the next block. In this case, the workpiece coordinates at the time of skip signal input are recorded. The recorded data can be read with the direct command for reading skip measurement data (function code 0x32).

- Response command format
This command has no response data.
It only inverts EBSY.

NOTE

- 1 To use SMZX, bit 7 (CSMZ) of parameter No. 002 must be set to "1".
- 2 "Cutting feed" means feed which is neither rapid traverse nor jog (JOG) feed.
- 3 When RPD = 0 and SMZX = 1, if bit 3 (CIPC) of parameter No. 002 is "0", an in-position check is performed at the end of the command with the in-position width set in parameter No. 111.
- 4 The in-position check during reference position return (function code: 0x60) is the same as that if RPD is "1" (equivalent to that described in SMZX<2>). In addition to the signals mentioned in SMZX<2>, check if the reference position return completion signal ZPX(Xx+2#0) is 1.
- 5 To use the skip function, bit 0 (HENB) of parameter No. 017 must be set to "1".
- 6 It is possible to specify, using an appropriate parameter, whether to retain the previous skip measurement data or record the specified end point coordinates if, during the execution of the skip function, the skip signal (HDI) is not input and the end point is reached. If bit 2 (SPCO) of parameter No. 17 is "0", the previous skip measurement data is recorded; if "1", the specified end point coordinates.
- 7 If, during the execution of the skip function, the execution is interrupted due to an external reset, emergency stop, alarm, etc., no skip measurement data is updated.

(3) Incremental positioning

This command instructs the servo amplifier module to perform incremental positioning. The motor moves through a specified amount of travel.

● Instruction command format

	#7	#6	#5	#4	#3	#2	#1	#0	
Yy+4	Control flag 1								
Yy+5	0	1	1	0	0	0	1	0	(0x62)
Yy+6	0	0	0	0	NMOD	0	0	1	
Yy+7	SKIP	RPD	SMZX	0	0	0	0	1	
Yy+8	Feedrate								
Yy+9	Incremental travel amount								
Yy+10									
Yy+11									
Yy+12									
Yy+13									

Feedrate : 1 to 65535 [10^N user-specified unit/MIN]]
(N is set with parameter No. 021.)

Incremental travel amount:
-99999999 to 99999999 [user-specified unit]

NMOD = 1 : Execution completion notification mode
(For details, see Section 4.2.)

SMZX = 1 : Performs an in-position check during cutting feed.

<1> If RPD is "0" and SMZX is "1", an in-position check is performed with the in-position width set in parameter No. 137 (when bit 3 (CIPC) of parameter No. 002 = 1) at the end of the command. After the end of the command, confirm whether the motor is in position by checking if the following are true: Distribution pulse signal IPLX ($Xx+0\#1$) = 0, acceleration/deceleration pulse signal SUPX ($Xx+0\#2$) = 0, in-position signal INPX ($Xx+0\#3$) = 1, axis movement signal MVX ($Xx+3\#2$) = 0, and automatic operation start signal STL ($Xx+1\#5$) = 0.

<2> If RPD is "1", an in-position check is performed with the in-position width set in parameter No. 111. After the end of the command, confirm whether the motor is in position by checking if the following are true: Distribution pulse signal IPLX ($Xx+0\#1$) = 0, acceleration/deceleration pulse signal SUPX ($Xx+0\#2$) = 0, in-position signal INPX ($Xx+0\#3$) = 1, axis movement signal MVX ($Xx+3\#2$) = 0, and automatic operation start signal STL ($Xx+1\#5$) = 0.

RPD = 1 : Rapid traverse

SKIP = 1 : Skip function used

If the command is being executed independently when the skip signal (HDI) is input, axis movement is stopped immediately and command execution is ended. If during thirty-two-buffering operation, the currently executed block is skipped to proceed to the next block. In this case, the workpiece coordinates at the time of skip signal input are recorded. The recorded data can be read with the direct command for reading skip measurement data (function code 0x32).

- Response command format
This command has no response data.
It only inverts EBSY.

NOTE

- 1 To use SMZX, bit 7 (CSMZ) of parameter No. 002 must be set to "1".
- 2 "Cutting feed" means feed which is neither rapid traverse nor jog (JOG) feed.
- 3 When RPD = 0 and SMZX = 1, if bit 3 (CIPC) of parameter No. 002 is "0", an in-position check is performed at the end of the command with the in-position width set in parameter No. 111.
- 4 The in-position check during reference position return (function code: 0x60) is the same as that if RPD is "1" (equivalent to that described in SMZX<2>). In addition to the signals mentioned in SMZX<2>, check if the reference position return completion signal ZPX(Xx+2#0) is 1.
- 5 To use the skip function, bit 0 (HENB) of parameter No. 017 must be set to "1".
- 6 It is possible to specify, using an appropriate parameter, whether to retain the previous skip measurement data or record the specified end point coordinates if, during the execution of the skip function, the skip signal (HDI) is not input and the end point is reached. If bit 2 (SPCO) of parameter No. 17 is "0", the previous skip measurement data is recorded; if "1", the specified end point coordinates.
- 7 If, during the execution of the skip function, the execution is interrupted due to an external reset, emergency stop, alarm, etc., no skip measurement data is updated.

(4) Dwell

This command instructs the servo amplifier module to perform dwell. The execution of the next block can be delayed by a specified amount of time.

● Instruction command format

	#7	#6	#5	#4	#3	#2	#1	#0	
Yy+4	Control flag 1								(0x63)
Yy+5	0	1	1	0	0	0	1	1	
Yy+6	0	0	0	0	NMOD	0	0	1	
Yy+7	0	0	0	0	0	0	0	1	
Yy+8	Dwell time								
Yy+9									
Yy+10									
Yy+11									

Dwell time: 1 to 99999999 [msec]

NMOD = 1 : Execution completion notification mode
(For details, see Section 4.2.)

● Response command format

This command has no response data.
It only inverts EBSY.

(5) Setting a coordinate system

The absolute position of the servo amplifier module is preset at a specified coordinate value.

● Instruction command format

	#7	#6	#5	#4	#3	#2	#1	#0	
Yy+4	Control flag 1								(0x64)
Yy+5	0	1	1	0	0	1	0	0	
Yy+6	0	0	0	0	NMOD	0	0	1	
Yy+7	0	0	0	0	0	0	0	1	
Yy+8	Coordinate system setting value								
Yy+9									
Yy+10									
Yy+11									

Dwell time: -99999999 to 99999999 [user-specified unit]

NMOD = 1 : Execution completion notification mode
(For details, see Section 4.2.)

● Response command format

This command has no response data.
It only inverts EBSY.

(6) Acquiring the FIN state

The host issues this command to check whether the servo amplifier module is waiting for FIN in command completion notification mode.

● Instruction command format

	#7	#6	#5	#4	#3	#2	#1	#0	
Yy+4	Control flag 1								
Yy+5	0	1	1	0	0	1	1	0	(0x66)

● Response command format

	#7	#6	#5	#4	#3	#2	#1	#0	
Xx+4	Control flag 2								
Xx+5	0	1	1	0	0	1	1	0	(0x66)
Xx+6	Reserved				Execution result				
Xx+7								ECF0	

ECF0 = 1 : Command completed (waiting for the FIN command)

NOTE

This command is valid when command completion notification mode is set (NMOD = 1).

(7) FIN command

If the servo amplifier module is waiting for FIN in command completion notification mode, the host issues this command to release the FIN wait state.

● Instruction command format

	#7	#6	#5	#4	#3	#2	#1	#0	
Yy+4	Control flag 1								
Yy+5	0	1	1	0	0	1	1	1	(0x67)
Yy+6								ECFIN0	

ECFIN0 : FIN specification
 If the servo amplifier module is waiting for FIN (ECF0 = 1) in command completion notification mode, the host responds with this command.

● Response command format

	#7	#6	#5	#4	#3	#2	#1	#0	
Xx+4	Control flag 2								
Xx+5	0	1	1	0	0	1	1	1	(0x67)
Xx+6	Reserved				Execution result				

(8) Velocity control

Speed control is issued to the servo amplifier module. The motor moves at the specified speed command value (speed).

● Instruction command format

	#7	#6	#5	#4	#3	#2	#1	#0	
Yy+4	Control flag 1								(0x6F)
Yy+5	0	1	1	0	1	1	1	1	
Yy+6	0	0	0	0	0	0	0	1	
Yy+7	0	0	0	0	0	0	0	1	
Yy+8	Function selection								
Yy+9	Speed command value								
Yy+10	Torque limit value								
Yy+11	Torque limit value								
Yy+12	Torque limit value								

Function selection =

- 1 : Start or speed change command (torque limit disabled)
- 2 : Start of spec change command (torque limit enabled)
- 3 : Stop command

Speed command value : ±0 to maximum speed of the motor [min⁻¹]

Torque limit value : 0 to 7282

Determine the setting with the following formula:

Setting = Torque limit value [%] x

A setting of 0 is regarded as 100% (7282).

[Example]

To set the torque limit to 50% with a speed command of 1500 min⁻¹.

Speed command value = 1500 (= 05DCh) min⁻¹

Setting of the torque limit value = 50% x (7282/100) = 3641 (= 0E39h)

Yy+8	2
Yy+9	DC
Yy+10	05
Yy+11	39
Yy+12	0E

● Response command format

This command has no response data.

It only inverts EBSY.

NOTE

- 1 The maximum speed of the motor depends on the motor used.
- 2 If the function selection is "1", the torque limit value need not be specified. The torque limit is invalid and 100% is assumed.
- 3 If the function selection is "2", to change only the torque limit value with the speed unchanged, specify the same speed command value as the previous one.
- 4 If the function selection is "2", the specified torque limit value is clamped with the setting of parameter No. 080 (current limit value).
- 5 If the function selection is "3", the speed command value and the torque limit value need not be specified. After the stop command, the system returns to the torque limit value assumed before the start of speed control (determined with parameter No. 108 and bit 2 of parameter No. 10).

● Parameter

No	#7	#6	#5	#4	#3	#2	#1	#0
000	ROAX						ROTX	

[Size] 1 byte (bit type)
 [Standard value] 0

ROTX Specifies whether the controlled axis is a linear or rotation axis, as follows:
 0 : Linear axis
 1 : Rotation axis
 * Set this bit to "1" to perform speed control.

ROAX Specifies whether the roll-over function of the rotation axis is valid, as follows:
 0 : Invalid
 1 : Valid
 * Set this bit to "1" to perform speed control.

No	Load inertia ratio (LDINT)
100	

[Size] 2-byte
 [Valid data range] 0 to 1024

Set the ratio of the load inertia of the machine to the inertia of the motor, using the value calculated with the formula below as a rough guide:
 Load inertia ratio = (load inertia of the machine/inertia of the motor) x 256
 If the calculated value exceed 500, set 500.
 By setting a value here, the velocity loop gain will be PK1V, and PK2V will be (1 + LDINT/256).

The larger this value, the higher the responsiveness to the speed command and the higher the servo rigidity. Too large a value, however, will cause the servo system to vibrate and abnormal sound during machine movement. Normally, regard about 500 as the upper limit. If the machine vibrates at a high frequency, the torque command filter (parameter No. 102) is effective.

No	
116	Velocity loop gain override during velocity control (%)
[Size]	2-byte
[Standard value]	0 (overriding not performed)
	Set this parameter if the system is switched between position control and velocity control.
	When the system enters velocity control mode, the velocity loop proportional gain and the integral gain that are used in position control are multiplied by the above override.
	The relationships among the velocity loop proportional gain, integral gain, load inertia ratio, and the velocity loop gain override during velocity control are explained using the following example:
	Assume the following:
	Integral gain = 100
	Proportional gain = -500
	Load inertia ratio = 128
	Velocity loop gain override during velocity control = 200%
	[Gain during position control]
	Integral gain = $100 \times (1+128/256) = 150$
	Proportional gain = $-500 \times (1+128/256) = -750$
	[Gain during velocity control]
	Integral gain = $100 \times (1+128/256) 200/100 = 300$
	Proportional gain = $-500 \times (1+128/256) 200/100 = -1500$
	Thus, the gain with the load inertia ratio taken into consideration is multiplied by the gain override during velocity control.

No	
135	Linear acceleration/deceleration time constant for velocity control
[Size]	2-byte
[Unit of data]	ms
[Valid data range]	8 to 4000
	Specify the time required to reach 4000 min ⁻¹ .
	Example)
	If the value specified for velocity is 2000 min ⁻¹ , and the time required to reach 2000 min ⁻¹ is to be 1000 msec, the value to be set is calculated as follows:
	Value to be set = $(4000/2000) \times 1000 = 2000$

No
136 Velocity deviation check limit during velocity control

[Size] 2-byte
 [Unit of data] min⁻¹
 [Valid data range] 0 to 4000
 [Standard value] 0 (velocity deviation check not performed)

Set the limit on the velocity deviation check to be performed in velocity control mode.

In velocity control mode, alarm No. 447 is issued if the deviation of the actual velocity from the specified velocity exceeds the value set for this parameter.

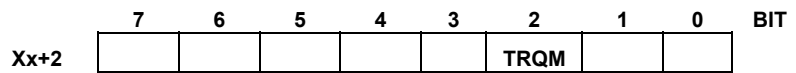

● Signal



Speed control mode signal TRQM

[Classification] Input signal <Xx+2#2>
 [Function] The servo amplifier module notifies that the system is in speed control mode.
 [Input condition] The signal becomes 1 when:
 1. Speed control is started and the system is in speed control mode.
 The signal becomes 0 when:
 1. A speed control stop command is executed.
 2. A servo alarm, overtravel alarm, reset, emergency stop, or servo off

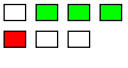
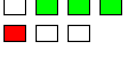
● Alarm

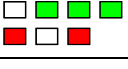
No.	LED indication	Description	Action
250		Command data 1 (peripheral equipment control) or instruction command (direct command) is invalid.	Check the specified value of command data 1 of peripheral equipment control/function code command. Check the specified value of the direct command (instruction command).
254		The function code or mode is invalid.	Check the specified value of the function code of the function code command. Check the mode.
255		An attempt to start fails because the mode is wrong or a block is being executed.	Check the mode. Check if a block is being executed.
447		Too much speed deviation (speed control)	Check the actual speed. Check the contents of parameter No. 136.

- Others
 - (i) The following parameters usually need to be changed to perform speed control.
Do not change any other parameters.
No.000 (bit 1): Set it to 1. (Rotation axis specification)
No.000 (bit 7): Set it to 1. (Rotation axis rollover enabled)
No.100: Load inertia ratio. Set an adjusted value.

The following parameters are for speed control only; once values are set, they usually need not be changed at each switching.
No. 116: Velocity loop gain override during speed control. (To be set to switch between position control and speed control)
No. 135: Linear acceleration/deceleration time constant for speed control.
No. 136: Speed deviation check limit value during speed control.
 - (ii) The actions with output signals during speed control are as follows:
If an overtravel alarm is issued, speed control mode ends after a deceleration stop. If the external reset signal ERS (Yy+1#0) becomes "1", speed control mode ends after a deceleration stop. If the interlock signal *ILK (Yy+1#3) becomes "0", a deceleration stop occurs. If it becomes "1" again, movement restarts with acceleration.
If the servo off command signal SVFX (Yy+1#2) becomes "1", speed control mode ends after deceleration stop.
 - (iii) The states of the input signals during speed control are as follows:
Because the position is updated by performing follow-up, the axis movement signal MVX (Xx+3#2) and the distribution pulse signal IPLX (Xx+0#1) become "1".
During movement in one direction, the movement direction signal MVDX (Xx+3#0) becomes "1".
The automatic operation signal OP (Xx+1#7) and the automatic operation start signal STL (Xx+1#5) become "1".

(9) Wait command

This command instructs the servo amplifier module to wait. When this command is executed, the servo amplifier module outputs the wait signal WAT [2.3.14(14)] to the host and enters the wait state. To cancel the wait state, the host sets the wait completion signal WFN [2.3.14(15)] to "1". This causes the servo amplifier module to set the WAT signal to "0". Upon confirming that the WAT signal has become "1", the host sets the WFN signal to "0". With these actions, the wait state is canceled and the servo amplifier module moves to the next block.

● Instruction command format

	#7	#6	#5	#4	#3	#2	#1	#0	
Yy+4	Control flag 1								
Yy+5	1	0	0	1	0	0	0	0	(0x90)
Yy+6	0	0	0	0	0	0	0	0	
Yy+7	ID code (1 to 255)								

● Response command format

	#7	#6	#5	#4	#3	#2	#1	#0	
Xx+4	Control flag 2								
Xx+5	1	0	0	1	0	0	0	0	(0x90)
Xx+6	Reserved				Execution results				
Xx+7									
Xx+8									
Xx+9	ID code (same ID code as that of the instruction command)								

NOTE

- 1 The ID code of the instruction command is effective when bit 5 (WAT2) of parameter No. 003 is 1.
- 2 The response command is output when bit 5 (WAT2) of parameter No. 003 is 1.
When the response command is output, the host returns an answer by reading the ID code and inverting the response data read completion signal EOREND [2.3.14(8)].
Then, the host checks the WAT signal and controls the WFN signal so that it changes from "0" to "1" and back to "0".

4.5 THIRTY-TWO-BLOCK BUFFERING OPERATION

4.5.1 Overview

The host can register and execute up to 32 blocks of direct commands in the internal memory of the servo amplifier module.

NOTE

One block consists of one instruction command which is a direct command.

4.5.2 Memory Registration Procedure

The host registers up to 32 blocks of direct commands in the internal memory of the servo amplifier module by means of the procedure explained below.

- (1) The host sets memory registration signal INPF [2.3.14 (16)] to 1.
- (2) After confirming that memory registration in-progress signal INPFO [2.3.14 (17)] has been set to 1, the host registers direct commands in the servo amplifier module through EBUF/EBSY control.
- (3) Upon the completion of registration, the host sets memory registration signal INPF to 0.

CAUTION

The registered blocks are all erased when the INPF signal state is changed from 0 to 1. Also, the registered blocks are all erased when the power is disconnected.

NOTE

An attempt to register more than 32 blocks results in the issue of alarm 70.

4.5.3 Operation Procedure

The host operates and executes registered direct commands by means of the procedure explained below.

- (1) Select AUTO mode. (MD1 = 1, MD2 = 0, MD4 = 0 [2.3.4 (1)])
- (2) Change the status of automatic operation start signal ST [2.3.10 (1)] from 1 to 0. When the level of the ST signal falls, buffering operation starts. (It is also possible to start operation when the ST signal level rises by parameter setting (bit 7 (STON) of parameter No. 3)).

NOTE

- 1 After the last block has been executed, operation is halted. To perform operation again from the first block, cause a reset to locate the first block, then start operation by using the ST signal. A reset causes the top of the registered blocks to be located.
- 2 During buffering, switching the ST signal state from 0 to 1 causes a single-block stop. To restart operation, change the ST signal state from 1 to 0.
- 3 During the execution of buffering operation, switching the INPF signal from "0" to "1" causes a single-block stop, deleting all registered blocks.
- 4 If, in the halt state, an attempt is made to start operation with the ST signal with the INPF signal changed from "0" to "1", alarm 254 is issued.
- 5 If, during the execution of a skip command block, the skip signal (HDI) is input, the currently executed block is skipped to proceed to the next block.

5

EXTERNAL PULSE INPUT FUNCTION

5.1 OVERVIEW

This function enables movement in sync with external pulses generated from the machine.

Input external pulses to connector JA34.

5.2 DETAILED DESCRIPTION

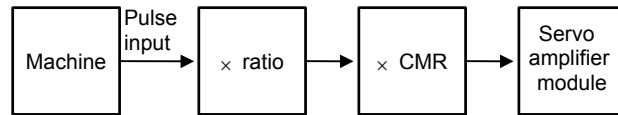

- (1) Input external pulses to connector JA34. The A-phase (PA, *PA) and B-phase (PB, *PB) signals are used for an input waveform as well as for a position coder output waveform. The C-phase signal is not required.
- (2) The ratio of the amount of travel along an axis to an external pulse can be set with parameters. The ratio is expressed as M/N (where, M = parameter magnification 1 (parameter No. 0062), N = parameter magnification 2 (parameter No. 0063)).
- (3) When the A-phase signal is 90° ahead of the B-phase signal, movement is performed in the positive direction.
When the A-phase signal lags 90° behind the B-phase signal, movement is performed in the negative direction.
- (4) Parameter setting (bit 6 (EXPLS) of parameter No. 0003) determines whether to enable axis movement by external pulses.
- (5) For axis movement by external pulses, interlock and overtravel detection are valid.
- (6) The acceleration/deceleration type used for axis movement by external pulses is the same as that for jog feed. (Set bit 1 (JOGE) of parameter No. 0002.)
- (7) Select manual handle mode. This mode is selected when signal output is performed from the host to a servo amplifier module (MD1 = 0, MD2 = 0, MD4 = 1 [2.3.4 (1)]).
- (8) If the feedrate for axis movement by external pulses exceeds the upper limit for a specified feedrate, as set in parameter No. 43, a choice of the following responses can be made by parameter setting (bit 6 (EPEXA) and bit 7 (EPEXB) of parameter No. 0001):
 - (a) The feedrate is clamped to the upper limit, and the excess pulses are accumulated.
If the number of accumulated pulses exceeds 99999999, the excess pulses are discarded.
 - (b) The feedrate is clamped to the upper limit, and the excess pulses are discarded.
 - (c) Alarm 291 is issued, and movement is decelerated and stopped.

NOTE

This function does not operate unless the motor has been activated. When this function is used, therefore, clamping/unclamping using the unclamp command signal (UCPC2) and the clamp/unclamp state output signal (UCPS2) (when bit 1 (NCLP of parameter No. 003 is "0") cannot be used. Perform clamping/unclamping, using the servo off signal (SVFX).

6

UNEXPECTED DISTURBANCE TORQUE DETECTION FUNCTION

Optional function

6.1 OVERVIEW

In the event of a machine collision, for example, the servo motor receives higher load torque than in normal feed.

This function estimates the load torque to be received by this motor, and upon detecting an abnormal value, brings the servo motor to an emergency stop or retract the motor in the direction opposite to the advance direction, thereby reducing damage to the machine.

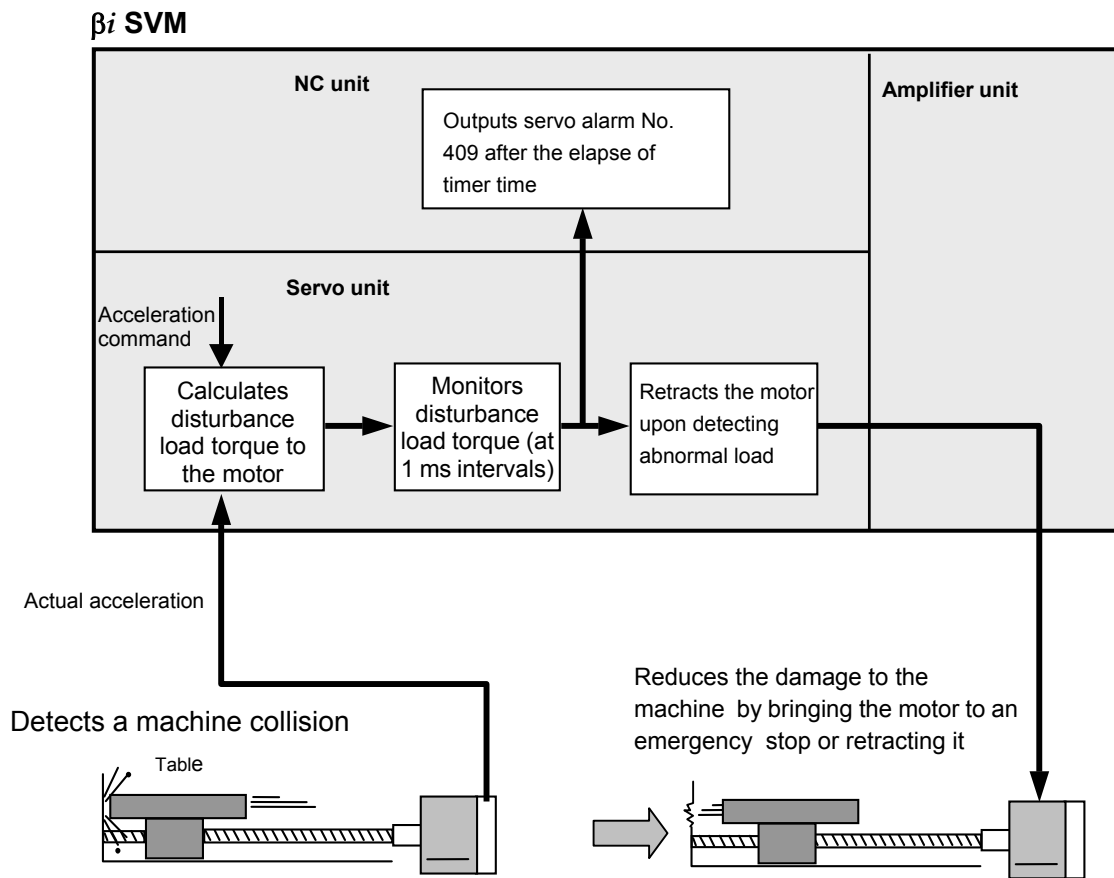

6.2 SERIES AND EDITIONS OF APPLICABLE SERVO SOFTWARE

Software programs of the following series and editions are required:

(β i SVM control software)

Series 88A6/01(A) and subsequent editions

(Power Mate CNC manager)

Series 8A01/01(A) and subsequent editions

(CNC software)

FS16i -MA Series B0F4/03 and subsequent editions

FS16i -TA Series B1F4/02 and subsequent editions

FS18i -MA Series BDF4/03 and subsequent editions

FS18i -TA Series BEF4/02 and subsequent editions

FS21i -MA Series DDF4/03 and subsequent editions

FS21i -TA Series DEF4/02 and subsequent editions

FS16i-MB Series B0H1/08 and subsequent editions

FS16i -TB Series B1H1/09 and subsequent editions

FS18i -MB Series BDH1/08 and subsequent editions

FS18i -MB5 Series BDH5/01 and subsequent editions

FS18i -TB Series BEH1/09 and subsequent editions

FS21i -MB Series DDH1/08 and subsequent editions

FS21i -TB Series DEH1/09 and subsequent editions

Power Mate *i* -D Series 88E0/15 and subsequent editions

Power Mate *i* -H Series 88F1/09 and subsequent editions

Power Mate *i* -H Series 88F2/01 and subsequent editions

FS30i -A Series G001/22 and subsequent editions

Series G011/22 and subsequent editions

Series G021/22 and subsequent editions

Series G002/01 and subsequent editions

Series G012/01 and subsequent editions

Series G032/01 and subsequent editions

FS31i -A Series G101/01 and subsequent editions

Series G121/01 and subsequent editions

FS31i -A5 Series G111/01 and subsequent editions

Series G131/01 and subsequent editions

FS32i -A Series G201/01 and subsequent editions

6.3 SETUP METHOD

6.3.1 Overview

To use the unexpected disturbance torque detection function, set appropriate parameters beforehand, using the procedure below.

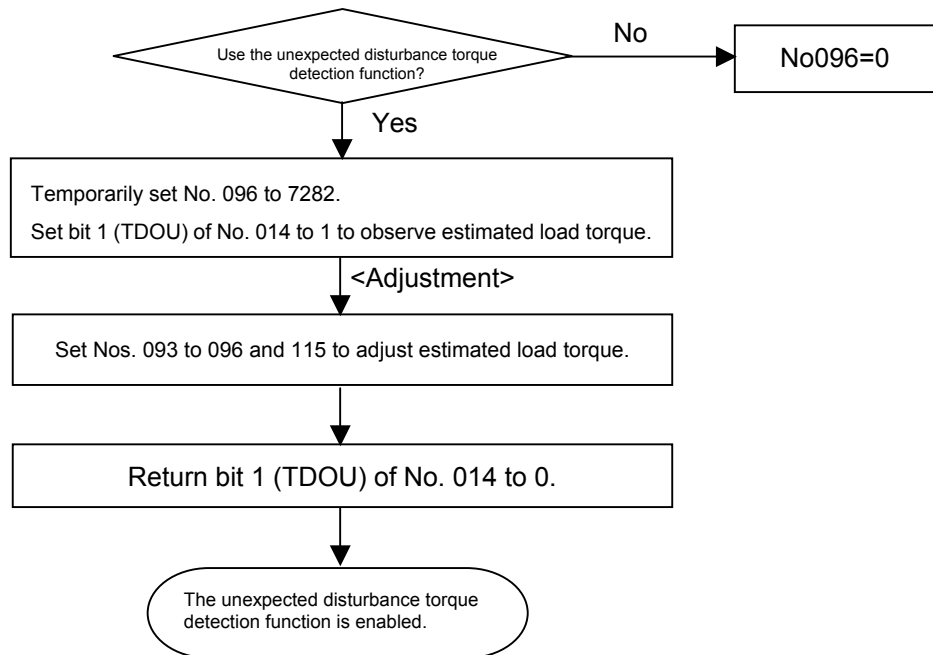

6.3.2 Details of the Setup Method

- <1> Confirm that the unexpected disturbance torque detection function is usable.
Confirm that the unexpected disturbance torque detection function is usable, using diagnosis (DGN) No. 034#1 (ABTDTC) and the signal Xx+1#3 (OPTENB).
- <2> Temporarily set an alarm threshold
For adjustment, set parameter No. 096 to 7282 because no alarms will be detected and no estimated load torque will be calculated if the alarm threshold of abnormal load detection is 0.
- <3> Observe the estimated load torque.
Set bit 1 (TDOU) of parameter No. 014 to 1 to output the estimated load torque to DATA1 on the check board and the acceleration command to DATA0.

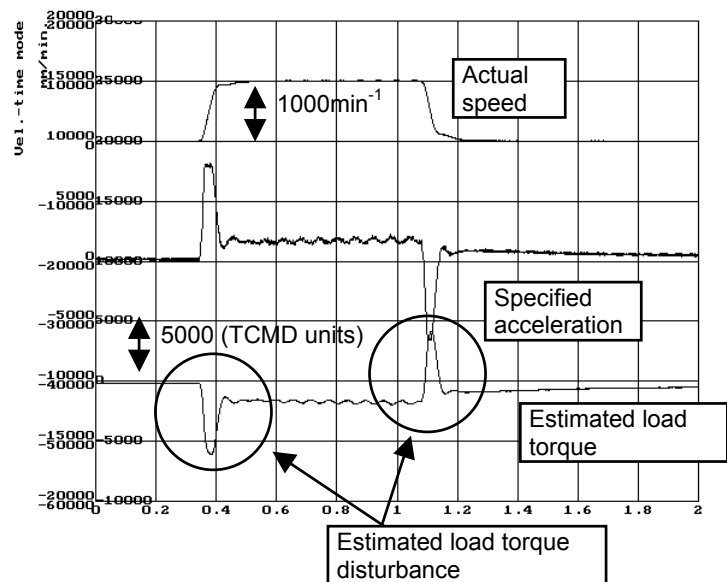

Fig. 6.3.2 (a) Before Adjustment

Fig. 6.3.2 (a) shows the actual speed, specified acceleration, and estimated load torque at a rapid traverse rate of 1000min^{-1} . Because the estimated load torque has not been adjusted, the estimated load torque is disturbed during acceleration and during a constant speed. The estimated load torque disturbance is corrected by adjusting the model constant and setting dynamic friction compensation, to be described later.

- <4> Adjust the model constant (parameter No. 115)
Parameter No. 115, model constant, represents the "torque constant/inertia". To perform estimation correctly, this parameter must be adjusted properly. Fig. 6.3.2 (b) shows results obtained after parameter No. 115 is set to a proper value in accordance with the machine inertia.

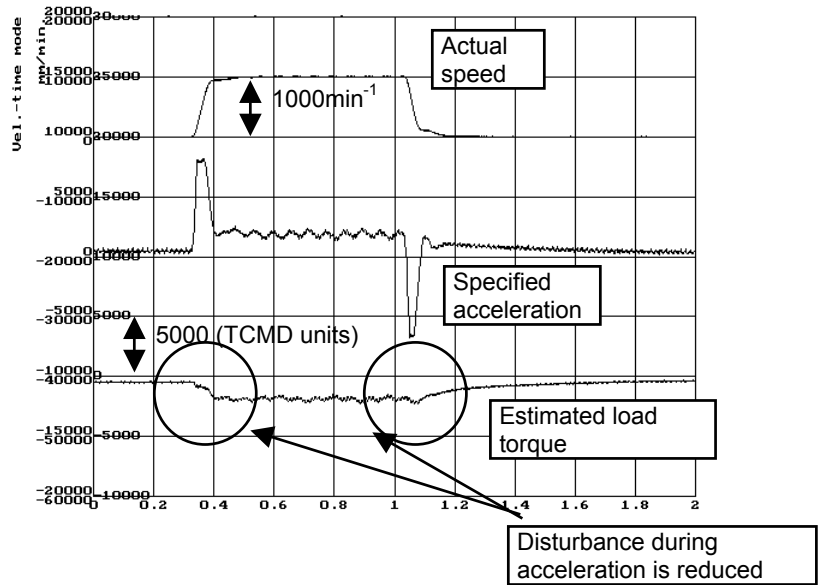

Fig. 6.3.2 (b) After Adjusting the Model Constant

<5> Adjust dynamic friction compensation (parameter No. 94)
 Parameter No. 094, dynamic friction compensation, removes the effect of dynamic friction. Measure the estimated load torque at 1000 min⁻¹ and set the measurement in parameter No. 094 in torque command units (with the maximum current value of the amplifier being assumed 7282).
 Because in Fig. 6.3.2 (b), the estimated load torque at 1000min⁻¹ is about 1800 during a constant speed, set parameter No. 094 to 1800. The results obtained after this parameter is applied are shown in Fig. 6.3.2 (c); the estimated load torque at 1000min⁻¹ is 0.

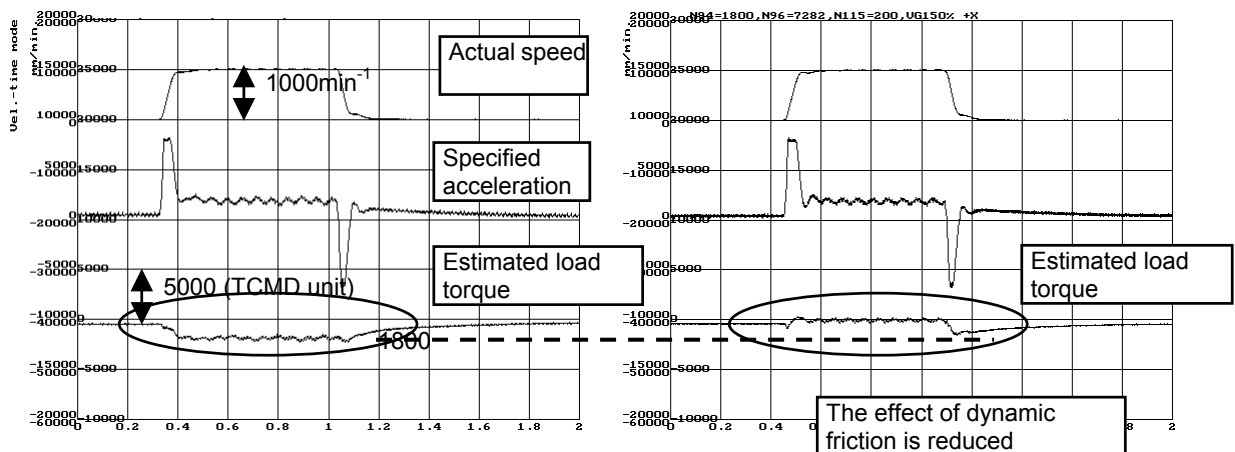

Fig. 6.3.2 (c) Adjustment of Dynamic Friction Compensation

<6> Adjust the torque offset (parameter No. 93)

For axes to which a constant force is applied constantly, such as the vertical axis, set parameter No. 093, torque offset, to remove the effect. In the case of Fig. 6.3.2 (d), it is seen that the offset of the estimated load torque is -3000; set 3000, with the opposite sign, in parameter No. 093. As a result, waveform similar to that in Fig. 6.3.2 (c) is obtained.

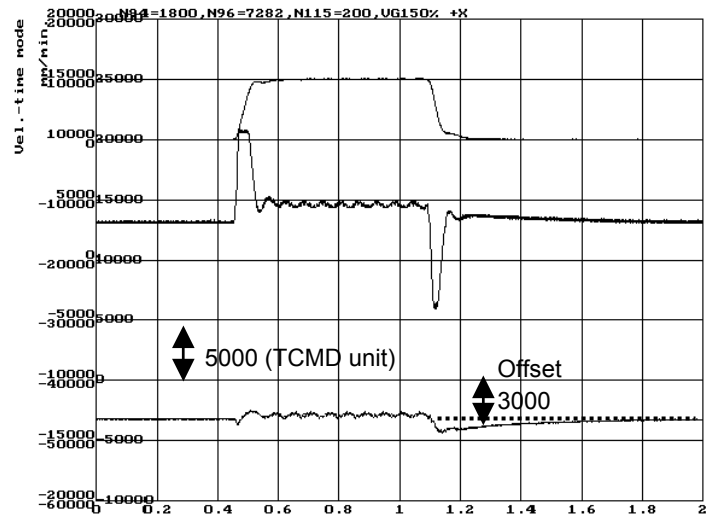

Fig. 6.3.2 (d) Torque Offset

<7> Adjust the retraction amount (parameter No. 95)

Set the retraction amount to be assumed if an abnormal load is detected. The tool moves in the direction opposite to the advance direction by the specified distance from the position at which the alarm is detected. If the setting of parameter No. 095, retraction amount, is 0, the tool stops at the position at which the alarm is detected.

<8> Adjust the alarm threshold (parameter No. 96)

Finally, set parameter No. 096, alarm threshold. As the threshold, set a value about 120 to 150% larger than that at which the estimated load torque is maximized.

In the example in Fig. 6.3.2 (e), a value of about 2000 is shown during rapid acceleration/deceleration and, therefore, set a value of about 2400 to 3000 in parameter No. 096. Fig. 6.3.2 (f) shows a collision example (when the unexpected disturbance torque detection function is disabled). Because the estimated load torque is 5000 at the collision, the unexpected disturbance torque detection function operates.

B-65395EN/01HANDLING **6.UNEXPECTED DISTURBANCE TORQUE DETECTION FUNCTION**

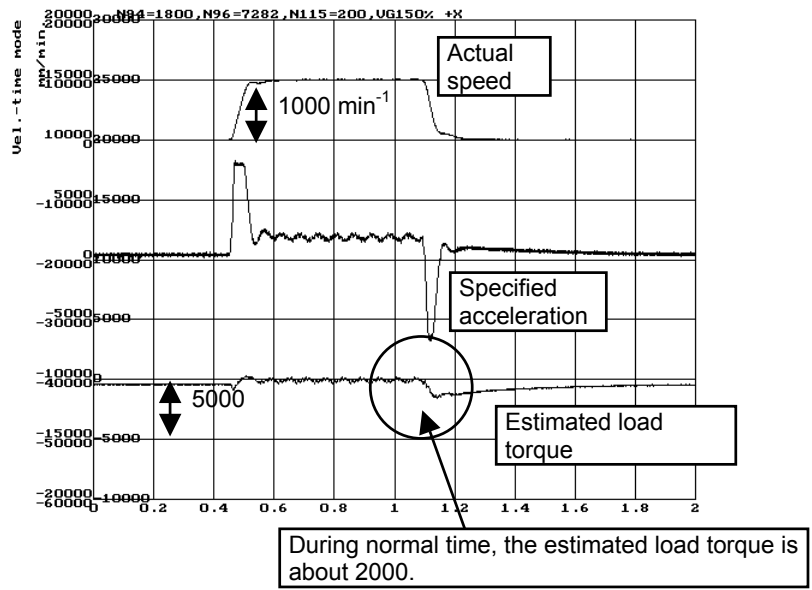

Fig 6.3.2 (e) Normal Time

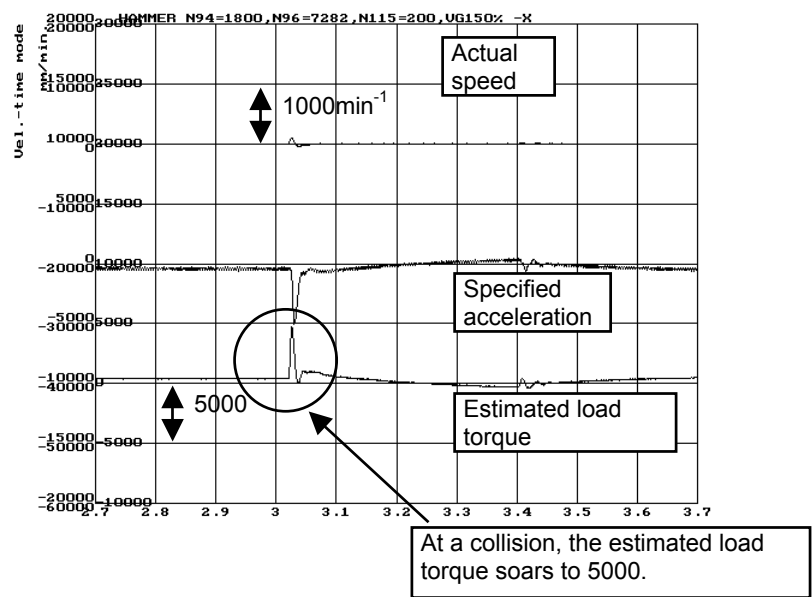
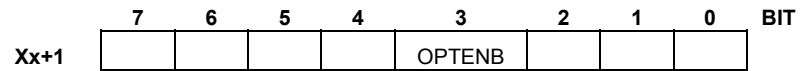

Fig. 6.3.2 (f) At a Collision

6.4 Signal



Function enable signal OPTENB

[Classification] Input signal <Xx+1#3> (common to both the peripheral equipment control and direct command interfaces)

[Function] The servo amplifier module notifies that the function is enabled (usable).

The function is as follows:

- Unexpected disturbance torque detection function (software option function)

[Input condition] The signal becomes 1 when:

1. The function is usable.

The signal becomes 0 when:

1. The function is under preparation, immediately after the power is turned on.
2. The function is not ordered.

CAUTION

The unexpected disturbance torque detection function is disabled until this signal becomes "1". Be sure to start axis movement after confirming that this signal has become "1".

6.5 Parameter

	No	130	Unexpected disturbance torque detection alarm timer
[Size]	2-byte		
[Unit of data]	msec		
[Valid data range]	0 to 32767 (200 msec if 0 is set)		
	Set the time from when an unexpected disturbance torque is detected to when a servo alarm is issued. A fraction smaller than 8 msec is rounded up.		
	Example) Setting of 30: assumed to be 32 msec		

	No	#7	#6	#5	#4	#3	#2	#1	#0
	014							TDOU	
[Size]	1 byte/bit type								
TDOU	Output to the check board								
	0 : The torque command is output to the check board.								
	1 : The estimated load torque is output to the check board.								
	The estimated load torque is output to DATA1, and the specified acceleration to DATA0. For both, the value weight is in TCMD unit (maximum current value being 4.4 V).								

NOTE

To output the estimated load torque to the check board, set bit 0 of parameter No. 014 to 0.

	No	115	Model constant
[Size]	2-byte		
[Valid data range]	0 to 32767		
	The model constant is a motor-specific value. Usually, it is fixed as a standard parameter. However, it should be tuned so as to obtain the estimated load torque correctly.		

NOTE

Load torque estimation takes the load inertia ratio into consideration. Changing the load inertia ratio causes the optimum value for the model constant to change. Determine the load inertia ratio, as the first step of the servo adjustment procedure.

If changing the setting of the load inertia ratio after determining the model constant, set a new model constant, using the following formula:

$$(\text{New model constant}) = \text{Parameter No. 115} \times \frac{\text{Load inertia ratio after adjustment} + 256}{\text{Load inertia ratio before adjustment} + 256}$$

Load inertia ratio: Parameter No. 100

6.UNEXPECTED DISTURBANCE TORQUE DETECTION FUNCTIONHANDLING B-65395EN/01

No
093 Estimated load torque: torque offset compensation

[Size] 2-byte
 [Unit of data] Torque command unit
 [Valid data range] -7282 to 7282 (7282 is the maximum current value of the amplifier)
 The setting is added to an estimated load torque, thereby eliminating an effect of stationary torque including gravity.

No
094 Estimated load torque: dynamic friction compensation coefficient

[Size] 2-byte
 [Unit of data] Torque command unit
 [Valid data range] 0 to 7282 (7282 is the maximum current value of the amplifier)
 [Setting value] An estimated load torque at 1000 min⁻¹ is measured and set.
 The compensation proportional to the speed is added to the estimated load torque, thereby eliminating an effect of dynamic friction.

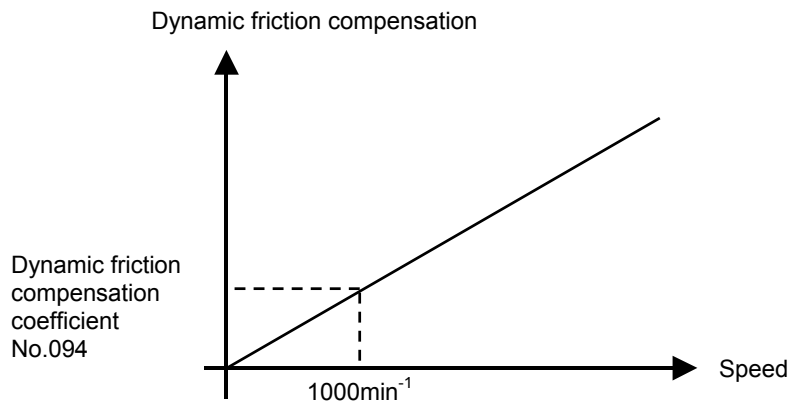

Set the compensation at 1000min⁻¹ in torque command units to compensate the value proportionate to the speed as dynamic friction.

No
095 Unexpected disturbance torque detection: retract distance

[Size] 2-byte
 [Unit of data] Detection unit
 [Valid data range] 0 to 65535
 [Setting value] Set approximately 3 mm.

NOTE

Even if this parameter is set, if the movement is at a speed lower than the that described below, retraction is not performed but the tool stops at the position at which an abnormal load is detected.

Let the value of the retraction parameter to be A,
 If the speed is equal to or less than A/8 x detection unit x 1000 [mm/min]: Stop at the detection point
 If the speed is equal to or greater than A/8 x detection unit x 1000 [mm/min]: Stop after retraction

	No	096	Unexpected disturbance torque detection: alarm threshold value
[Size]	2-byte		
[Unit of data]	Torque command unit		
[Valid data range]	0 to 7282 (7282 is the maximum current value of the amplifier)		
	Set a limit (threshold) value at which an unexpected disturbance torque detection alarm is issued. If the setting is 0, processing for unexpected disturbance torque detection is disabled, and alarm detection and calculation of an estimated load torque are not performed.		
	First set bit 1 (TDOU) of parameter No. 014 to 1 (bit 0 of parameter No.014 must be 0), and observe load torque. Then, set parameter No. 096 to a value greater than the maximum torque value.		

6.6 ALARM

Number	LED indication	Description	Action
409		An abnormal load is detected.	Look for the mechanical cause of the abnormal load. If there is no mechanical cause, increase the check amount of the parameter (No. 096).

6.7 DIAGNOSIS

(DGN number)	7	6	5	4	3	2	1	0
034							ABTDTC	

ABTDTC

Unexpected disturbance torque detection function is:
 0 : Disabled.
 1 : Enabled.

7

QUICK STOP FUNCTION

7.1 OVERVIEW

This function enables the motor to stop with a shorter distance than with a normal DB stop, by performing a stop operation in a controlled manner when a directly input emergency stop signal is input. To perform a stop operation in a controlled manner, it is necessary to set the delay time from the time the pressing of the emergency stop switch is recognized until the magnetic contactor of the amplifier is actually shut down. The βi SVM allows setting of 60 and 100 ms through appropriate parameter setting.

7.2 SERIES AND EDITIONS OF APPLICABLE SERVO SOFTWARE

Software of the following series and edition is necessary:
(control software)
Series 88A6 /01(A) and subsequent editions

7.3 SETTING METHOD

To use the quick stop function, set appropriate parameters with the procedure given below.

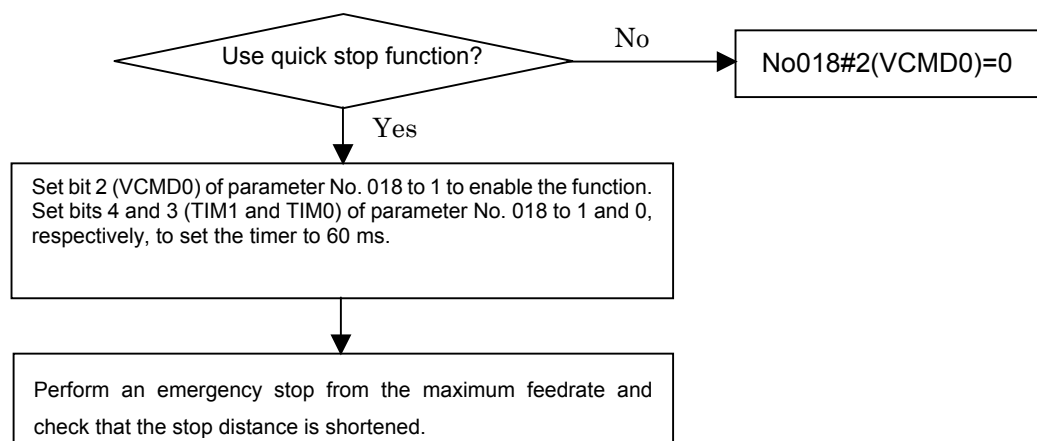

7.4 PARAMETER

No	#7	#6	#5	#4	#3	#2	#1	#0
018				TIM1	TIM0	VCMD0		

[Size] 1 byte/bit type
 VCMD0(#2) Quick stop function is:
 0 : Disabled.
 1 : Enabled.

TIM1,0(#4,#3) Setting of the MCC off timer
 The delay time from the time an emergency stop signal is input until MCC is turned off can be selected with a combination of TIM1 and TIM0. If VCMD0 is 0, the setting is invalid.
 Usually set it to 60 ms. If a sufficient effect cannot be obtained, set it to 100 ms.

Delay time	TIM1	TIM0
0ms	0	0
60ms	1	0
100ms	1	1

NOTE

- 1 It is not possible to set a delay time of 100 ms or greater by mounting an additional external timer.
- 2 Do not turn an emergency stop OFF/ON instantaneously.
- 3 The timer on the amplifier operates in conjunction with connector CX30 or with *ESP on CXA19B. It does not operate only with an emergency stop signal on the FANUC I/O Link between the host and a servo amplifier module.

III. TROUBLESHOOTING

1

OVERVIEW

This part describes the troubleshooting procedure. Read the section related to your current trouble to locate it and take an appropriate action.

First, check the LEDs on the servo amplifier modules or the alarm number (displayed on the host controller), examine the cause, and take an appropriate action.

2

ALARM NUMBERS AND BRIEF DESCRIPTIONS



Number	Alarm type	LED type (Classification by Red LED)
000 to 299	Program or setting alarm	or
300 to 399	Pulse coder alarm	
400 to 499	Servo alarm	or
500 to 599	Overtravel alarm	Same as PS alarm
-	System alarm or I/O Link alarm	or

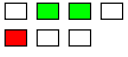
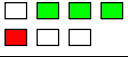
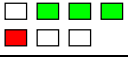
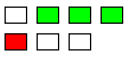
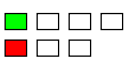
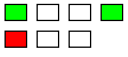
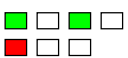
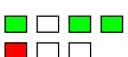
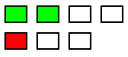
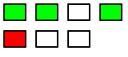

Program or setting alarms (PS alarms)

No.	LED display	Description	Countermeasure
000		A parameter that requires power-down has been specified.	Turn the power off, then back on.
011		The specified feedrate is zero.	Check the feedrate parameter specified with a function code.
013		The specified feedrate (maximum feedrate) is zero.	Check the value of parameter No.043, which indicates the maximum feedrate that can be specified.
070		More than 32 blocks have been registered for a buffering operation.	Reduce the number of registered blocks to 32.
090		Reference position setting cannot be executed normally.	Move the tool in the direction of reference position return in jog mode at a speed that causes the servo position error to exceed 128. Then, specify another reference position setting.
093		(1) A first to third reference position return cannot be executed because the reference position has not yet been established. (2) The reference position external setting was executed without Absolute pulse coder.	(1) Set the reference position. (2) Absolute pulse coder must be used.

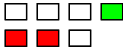
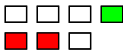
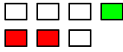
No.	LED display	Description	Countermeasure
224		The reference position has not yet been established. This occurs only when the ZRTN bit of parameter No.001 is set to 0.	Set the reference position.
250		Input data 1 or command is invalid.	Check input data 1, specified with a function code.
251		Input data 2 is invalid.	Check input data 2, specified with a function code.
254		A function code or mode is invalid.	Check the command code, specified with a function code. Check the mode.
255		Operation cannot be activated because an invalid mode is specified or because block execution is in progress.	Check the mode. Check whether a block is being executed.
290		The interface switch signal (DRC) was switched during block execution.	Switch the signal after block execution stops.
291		The speed of an axial movement specified by an external pulse has exceeded the upper limit. This occurs only when the EPEXA bit of parameter No.001 is set to 1.	Check the speed specified by the external pulse. Check the magnification of the external pulse (parameters No.062 and 063).
292		A checksum error for the nonvolatile memory was detected.	Parameters are cleared. Set the parameters again. If this alarm subsequently recurs, replace the unit.
293		Software version between FROM on CPU and EPROM is same.	Remove the EPROM.
294		CRC check alarm of EPROM was detected.	Remove the EPROM.

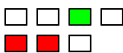
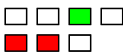
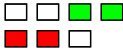
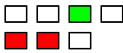
Pulse coder alarms

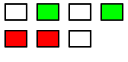

No.	LED display	Description	Countermeasure
300		A communication error (DTER) for the serial pulse coder was detected.	Check the continuity of the signal cable. If the cable is normal, the pulse coder or servo amplifier module may be defective. This error can also be caused by external noise. See the chapter on noise reduction in "Descriptions."
301		A communication error (CRCER) for the serial pulse coder was detected.	Check the continuity of the signal cable. If the cable is normal, the pulse coder or servo amplifier module may be defective. This error can also be caused by external noise. See the chapter on noise reduction in "Descriptions."
302		A communication error (STBER) for the serial pulse coder was detected.	Check the continuity of the signal cable. If the cable is normal, the pulse coder or servo amplifier module may be defective. This error can also be caused by external noise. See the chapter on noise reduction in "Descriptions."
303		An LED disconnection (LDAL) was detected in the serial pulse coder.	Turn the power off. If this alarm recurs when the power is reapplied, replace the motor.
304		A mispulse alarm (PMAL) for the serial pulse coder was detected.	Turn the power off. If this alarm recurs when the power is reapplied, replace the motor.
305		A miscount alarm (CMAL) for the serial pulse coder was detected.	Turn the power off. If the alarm recurs when the power is re-applied, replace the motor. Even if the alarm does not recur, restart the operation from reference position return.
306		The motor has overheated (OHAL).	This alarm is issued when the motor has overheated, causing the thermostat to trip. Possible causes include an excessively high ambient temperature and excessively strict operating conditions. Check the actual cause. If it occurs again when the motor is cooled, the motor or servo amplifier may have failed. Replace the faulty motor or servo amplifier.
308		A soft phase alarm (SPHAL) was detected.	Turn the power off. This alarm may be caused by noise.

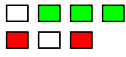
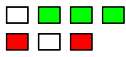
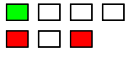

No.	LED display	Description	Countermeasure
319		When the absolute pulse coder is used, the motor has not yet rotated through more than one turn after the first power-up.	Cause the motor to rotate through more than one turn in jog feed mode, then turn the power off then back on.
350		The battery voltage of the absolute pulse coder is low.	Replace the battery. Restart the operation from reference position return.
351		The battery voltage of the absolute pulse coder is low. (warning)	Replace the battery.

Servo alarms

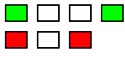
No.	LED display	Description	Countermeasure
400		The servo motor has overheated. (estimated value)	The motor operation condition may be too severe. Check the operation condition.
401		DRDY(Drive Ready signal) becomes 0. The servo amplifier is not ready.	
404		The regenerative discharge unit has overheated. (1) When the separate regenerative discharge resistor is not used. For the SVM1-4i and SVM1-20i, check whether the CXA20 connector is short-circuited by using a dummy connector. For the SVM1-40i and SVM1-80i, check whether the CXA20 and CZ6 connectors are short-circuited by using dummy connectors. (2) The average regenerative discharge energy may be too high. Decrease the acceleration/deceleration frequency. (3) The separate regenerative discharge unit may not be connected properly. Check the connection. (4) The thermostat of the separate regenerative discharge unit may be defective. Disconnect the separate regenerative discharge unit, then check the thermostat. If the thermostat is open even through the separate regenerative discharge unit is cool, replace the separate regenerative discharge unit. (5) The resistor of the separate regenerative discharge unit may be defective. Disconnect the separate regenerative discharge unit, then check the resistance. If it does not fall in the range of the predetermined resistance "20%", replace the separate regenerative discharge unit. (6) If from (1) to (5) are not the cause of the alarm, replace the servo amplifier module.	This alarm is issued when the average regenerative discharge energy is too high (when the acceleration/deceleration frequency is too high, for example).
405		Reference position return could not be executed correctly. If a value in the range of 4 to 96 is set for parameter No. 032 (CMR), an alarm may be issued. In this case, prevent an alarm from being issued by setting N405(bit4 of parameter No. 001) to "1".	Re-execute reference position return.
409		Unexpected disturbance torque has been detected.	Look for the mechanical cause of the abnormal load. If no mechanical cause is found, specify a larger value for the parameter.

No.	LED display	Description	Countermeasure
410		The servo position error in the stop state is larger than the value specified in parameter No.110.	Determine the mechanical cause of the large position error. If no mechanical cause is found, specify a larger value for the parameter.
411		The servo position error during movement is larger than the value specified in parameter No.182.	Determine the mechanical cause of the large position error. If no mechanical cause is found, apply any of the following countermeasures: <ul style="list-style-type: none"> • Specify a larger value for the parameter. • Specify a lower feed rate. • Increase the time constants.
412		<p>Over Current Alarm has been issued.</p> <p>(1) Check whether the motor ID number is correctly set in parameter No.125. (2) Check whether the standard values (see Appendix B) are specified in the current control parameters for servo control. Correct current control is possible only when the standard values are specified for the following parameters: No.70, 71, 72, 78, 79, 84, 85, 86, 87, 88, 89, 90, 99, 118, 119 (3) Disconnect the power line from the servo amplifier module connector. - Then, release the emergency stop state. If the over-current alarm continues to be issued, replace the servo amplifier module. - If no over-current alarm is issued, go to (4). (4) Check the insulation between the ground and each of U, V, and W. - If the insulation is satisfactory, go to (5). If a short-circuit is detected, disconnect the power line from the motor connector. Then, check the insulation between the ground and each of U, V, and W of the motor. - If a short-circuit is found between the ground and U, V, or W of the motor, replace the motor. - If the insulation is satisfactory, replace the power line. (5) Connect the power line. Observe the waveform of the motor current (IR, IS) while the motor is accelerating or decelerating. See the description of the checking of the motor current in Appendix E, "Servo Check Board". - If the motor current (IR, IS) does not exhibit a normal sine wave, replace the servo amplifier module. (6) Check if the motor current (IR, IS) waveforms include noise. - When noise is included, take an action such as making a connection to shield ground. - When noise is not included, replace the servo amplifier module.</p> <p>If (1) to (6) above are not the cause of the alarm, the pulse coder, command cable or internal hardware of the CNC may be defective.</p>	This alarm is issued when an excessively large current flows in the main circuit.

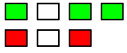
No.	LED display	Description	Countermeasure
413		<p>DC Link Over Voltage Alarm has been issued.</p> <p>(1)When SVM1-4<i>i</i> or SVM1-20<i>i</i> is used, and a separate regenerative discharge unit is not used, check the specification to see if regenerative energy per one time does not exceed the allowable regenerative energy of the servo amplifier module.</p> <p>(2)For the SVM1-40<i>i</i> and the SVM1-80<i>i</i>, when the separate regenerative discharge resistor is not used, check whether the CZ6 connector is short-circuited with a dummy connector.</p> <p>(3)The supply voltage for dynamic power may exceed the rated value. Check the voltage. If the voltage is too high, reduce the voltage to an appropriate level.</p> <p>(4)The regenerative discharge unit may not be properly connected. Check the connection.</p> <p>(5)The resistance of the separate regenerative discharge unit may be abnormal. Disconnect the separate regenerative discharge unit, then check the resistance. If the resistance is not within $\pm 20\%$ of the predetermined resistance, replace the separate regenerative discharge unit.</p> <p>If from (1) to (5) are not the cause of the alarm, replace the servo amplifier unit.</p>	<p>This alarm is issued when the DC voltage of the main circuit power is too high.</p>
414		<p>DC Link Low Voltage Alarm has been issued.</p> <p>(1) 190 ms or longer may pass from the time when both the *ESP of the built-in DI and the *ESP of the I/O link interface signal are canceled until the external magnetic contactor inserted into the input for motive power turns on(including the operating time of the magnetic contactor). The magnetic contactor must turn on within 100 ms.</p> <p>(2) The external circuit breaker may be turned off. Check the circuit breaker.</p> <p>(3) The supply voltage for dynamic power is lower than the rated value. Check the voltage. If the voltage is too low, increase it to an appropriate level.</p> <p>(4) The external magnetic contactor may not be connected properly. Check the connection.</p> <p>If from (1) to (4) are not the cause of the alarm, replace the servo amplifier unit.</p>	<p>This alarm is issued when the DC voltage of the main circuit power is too low.</p>

No.	LED display	Description	Countermeasure
416		<p>Inverter IPM Alarm has been issued.</p> <p>(1) Check whether the cooling fan is not stopped. (2) Check whether the motor is used within related current. (3) Check whether the temperature in locker is higher. Check the fin or filter in locker. (4) Check whether the temperature is higher around the servo amplifier module. (5) Disconnect the power line from the servo amplifier module connector. Then, release the emergency stop state. - If the IPM alarm continues to be issued, replace the servo amplifier module. - If no IPM alarm is issued, go to (6). (6) Disconnect the power line from the servo amplifier module connector. Then, check the insulation between the ground and each of U, V, and W. - If the insulation is satisfactory replace the servo amplifier module. - If the insulation is not satisfactory, go to (7). (7) Disconnect the power line from the servo motor. Then check the insulation. - If the insulation of servo motor is not satisfactory, replace the servo motor - If the insulation of power line is not satisfactory, replace the servo amplifier module.</p>	
417		<p>A parameter has been specified incorrectly.</p> <p>Check the following parameters:</p> <ul style="list-style-type: none"> - When the both No.030 and No.125 are set for motor ID number, this alarm is issued.it is necessary to set motor ID number on No.125 and to set 0 on No.030. - No.031: the parameter for direction of rotate is not selected in "111" or "-111". - No.106: Is the denominator of the number of pulses per single revolution of the motor 0? - No.107: Is this parameter too large? - No.179: Is this parameter out of range (8388607 lower or equal)? - Is No.107 (position gain)/No.105 or No.179 (number of pulses per single revolution of the motor) less than 0.488? - No.180: Is the specified reference counter capacity 0 or a negative value? 	

No.	LED display	Description	Countermeasure
423		The specified speed exceeds 32767000 detection units per second.	Re-examine the CMR and speed settings.
425		The fan for internal agitation has stopped. This alarm is issued when the fan motor built into the servo amplifier module has failed. The fan motor is consumable. For the explanation about its replacement procedure, see Part IV "Maintenance of Servo Amplifier Unit." (1) Check that the fan is not clogged with foreign matter. (2) Check that the power connector of the fan is connected properly. (3) Replace the fan or servo amplifier module.	
446		The external pulse input line is disconnected.	Connect the external pulse input signal correctly.
447		The velocity deviation is too high (velocity control)	Check the actual velocity. See the settings of parameter No.136.
449		No.080 is not corrected. (This parameter is out of range from 0 to 8010)	Set No.080 correctly (from 0 to 8010).
601		The fan for cooling the external radiator fin has stopped. This alarm is issued when the fan motor for inverter radiator has failed. The fan motor is consumable. For an explanation of the replacement procedure, see Part IV, "Maintenance of Servo Amplifier Unit." (1) Check that the fan is not clogged with foreign matter. (2) Check that the power connector of the fan is connected properly. (3) Replace the fan or servo amplifier module.	

Overtravel alarms

No.	LED display	Description	Countermeasure
500		The positive stroke limit has been exceeded.	Check whether *+OT and *-OT are connected correctly. Check whether a correct move command is specified.
501		The negative stroke limit has been exceeded.	Move the tool in the opposite direction in jog mode, then perform a reset.
510		The positive soft stroke limit has been exceeded.	Check whether appropriate values have been specified for parameters No.142 and 143. Check whether a valid move command is specified.
511		The negative soft stroke limit has been exceeded.	Move the tool in the opposite direction in jog mode, then perform a reset.

System alarms

No.	LED display	Description	Countermeasure
-		An error was detected in the RAM write/read test at power-up. (External SRAM)	Turn the power off then back on. If this alarm recurs, replace the servo amplifier module.
-		A watchdog alarm 1 was issued.	Turn the power off then back on. If this alarm recurs, replace the servo amplifier module.
-		A watchdog alarm 2 was issued.	Turn the power off then back on. If this alarm recurs, replace the servo amplifier module.
-		A watchdog alarm 3 was issued.	Turn the power off then back on. If this alarm recurs, replace the servo amplifier module.
-		The logic supply was less than 5V.	Turn the power off then back on. If this alarm recurs, replace the servo amplifier module.
-		The low voltage of the 24-VDC control supply was detected.	Check the 24-VDC control supply voltage. If the voltage is low, increase the voltage to an appropriate level.
-		An error was detected in the data collation check for the nonvolatile memory.	Turn the power off then back on. Then, re-enter the parameters. If this alarm recurs, replace the servo amplifier module.
-		A data transfer alarm for the nonvolatile memory has been issued.	Turn the power off then back on. If this alarm recurs, replace the servo amplifier module.
-		A CRC check alarm for the FROM that is built into the CPU is issued.	Turn the power off then back on. If this alarm recurs, replace the servo amplifier module.
-		A alarm for the servo amplifier module is issued. (Synchronous deviation alarm)	Turn the power off then back on. If this alarm recurs, replace the servo amplifier module.
-		A alarm for the servo amplifier module is issued. (Dead-band 0 alarm)	Turn the power off then back on. If this alarm recurs, replace the servo amplifier module.
-		A alarm for the servo amplifier module is issued. (Timer for skip position measurement)	Turn the power off then back on. If this alarm recurs, replace the servo amplifier module.
-		Loading of a software on the FROM that is built into the CPU is incomplete. An error was detected in the RAM write/read test at power-up. (Internal RAM) An error was detected in the control circuit.	Turn the power off then back on. If this alarm recurs, replace the servo amplifier module.

No.	LED display	Description	Countermeasure
-	□ □ □ □ □ ■ □ □	An error was detected in the control circuit.	Turn the power off then back on. If this alarm recurs, replace the servo amplifier module.
-	□ □ □ ■ ■ ■ ■	A alarm for the servo amplifier module is issued. (General illegal instruction)	Turn the power off then back on. If this alarm recurs, replace the servo amplifier module.
-	□ □ ■ □ ■ ■ ■	A alarm for the servo amplifier module is issued. (Slot illegal instruction)	Turn the power off then back on. If this alarm recurs, replace the servo amplifier module.
-	□ □ ■ ■ ■ ■ ■	A alarm for the servo amplifier module is issued. (CPU address error)	Turn the power off then back on. If this alarm recurs, replace the servo amplifier module.
-	□ ■ □ □ ■ ■ ■	A alarm for the servo amplifier module is issued. (DTC address error)	Turn the power off then back on. If this alarm recurs, replace the servo amplifier module.
-	□ ■ □ ■ ■ ■ ■	Stuck overflow occurred.	Turn the power off then back on. If this alarm recurs, replace the servo amplifier module.
-	□ ■ ■ □ ■ ■ ■	Stuck underflow occurred.	Turn the power off then back on. If this alarm recurs, replace the servo amplifier module.

I/O link alarm

No.	LED display	Description	Countermeasure
-	■ □ □ □ ■ ■ ■	A FANUC I/O Link error occurred. Some unit connected to the line was turned off.	Turn off the power to all units connected to the line. Then, turn on the slave devices, followed by the master device.

No LED display

No.	LED display	Description	Countermeasure
-	No indicators lit	The control circuit is not operating normally.	<p>(1) Check the 24-VDC control supply voltage. If the voltage is low, increase the voltage to an appropriate level.</p> <p>(2) Check whether a fuse in the servo amplifier module has blown. If a blown fuse is found, replace it, following the procedure described in Part IV "Maintenance of Servo Amplifier Unit."</p> <p>If (1) and (2) are not the cause, replace the servo amplifier.</p>

3

ACTION AGAINST NOISE

The servo amplifier module has been steadily reduced in size using surface-mount and custom LSI technologies for electronic components. The servo amplifier module also is designed to be protected from external noise. However, it is difficult to measure the level and frequency of noise quantitatively, and noise has many uncertain factors. It is important to prevent both noise from being generated and generated noise from being introduced into the servo amplifier module. This precaution improves the stability of the servo amplifier module machine tool system.

The servo amplifier module component units are often installed close to the parts generating noise in the power magnetics cabinet. Possible noise sources into the servo amplifier module are capacitive coupling, electromagnetic induction, and ground loops.

When designing the power magnetics cabinet, guard against noise in the machine as described in the following section.

- Separating signal lines

The cables used for the machine are classified as listed in the following table:

Process the cables in each group as described in the action column.

Group	Signal line	Action
A	Primary AC power line	Bind the cables in group A separately (Note 1) from groups B and C, or cover group A with an electromagnetic shield (Note 2). Connect spark killers or diodes with the solenoid and relay.
	Secondary AC power line	
	AC/DC power lines (containing the power lines for the servo motors)	
	AC/DC solenoid	
	AC/DC relay	
B	DC solenoid (24VDC)	Connect diodes with DC solenoid and relay. Bind the cables in group B separately from group A, or cover group B with an electromagnetic shield. Separate group B as far from Group C as possible. It is more desirable to cover group B with the shield.
	DC relay (24VDC)	
	DC power line	
C	Cable between the host and servo amplifier module	Bind the cables in group C separately from group A, or cover group C with an electromagnetic shield. Separate group C as far from Group B as possible. Be sure to perform shield processing.
	Cable for position and velocity feedback	
	External pulse input	
	Other cables to be covered with the shield	

NOTE

- 1 The groups must be 100mm or more apart from one another when binding the cables in each group.
- 2 The electromagnetic shield refers to shielding between groups with grounded steel plates.

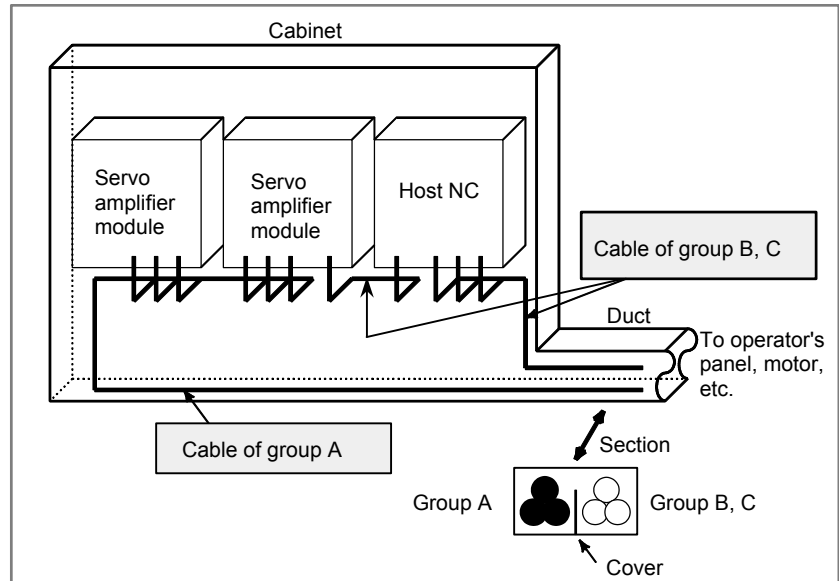

- Ground

The following ground systems are provided for the CNC machine tool:

- The signal ground supplies the reference voltage (0V) of the electrical signal system.
- The frame ground system is used for safety, and suppressing external and internal noises. In the frame ground system, the frames, cases of the units, panels, and shields for the interface cables between the units are connected.
- The protective earth (PE) is designed so that the protective grounds provided between the units are connected to ground at one point from a system point of view.

3.1 NOTES ON CONNECTING THE GROUND SYSTEMS

- The grounding resistance of the protective earth shall be 100 ohms or less (class D grounding).
- The protective earth (PE) cable must have enough cross-sectional area to safely carry the accidental current flow into the protective earth (PE) when an accident such as a short circuit occurs. (Generally, it must have the cross-sectional area of the AC power cable or more.)
- Use the cable containing the AC power wire and the protective earth (PE) wire so that power is supplied with the ground wire connected.

- Connecting the frame ground of the servo amplifier module

Connect the 0 V line of the electronic circuit in the servo amplifier module with the ground plate of the cabinet via the frame ground (FG) terminal.

The SG terminal is located on the printed circuit board at the rear of the control unit.

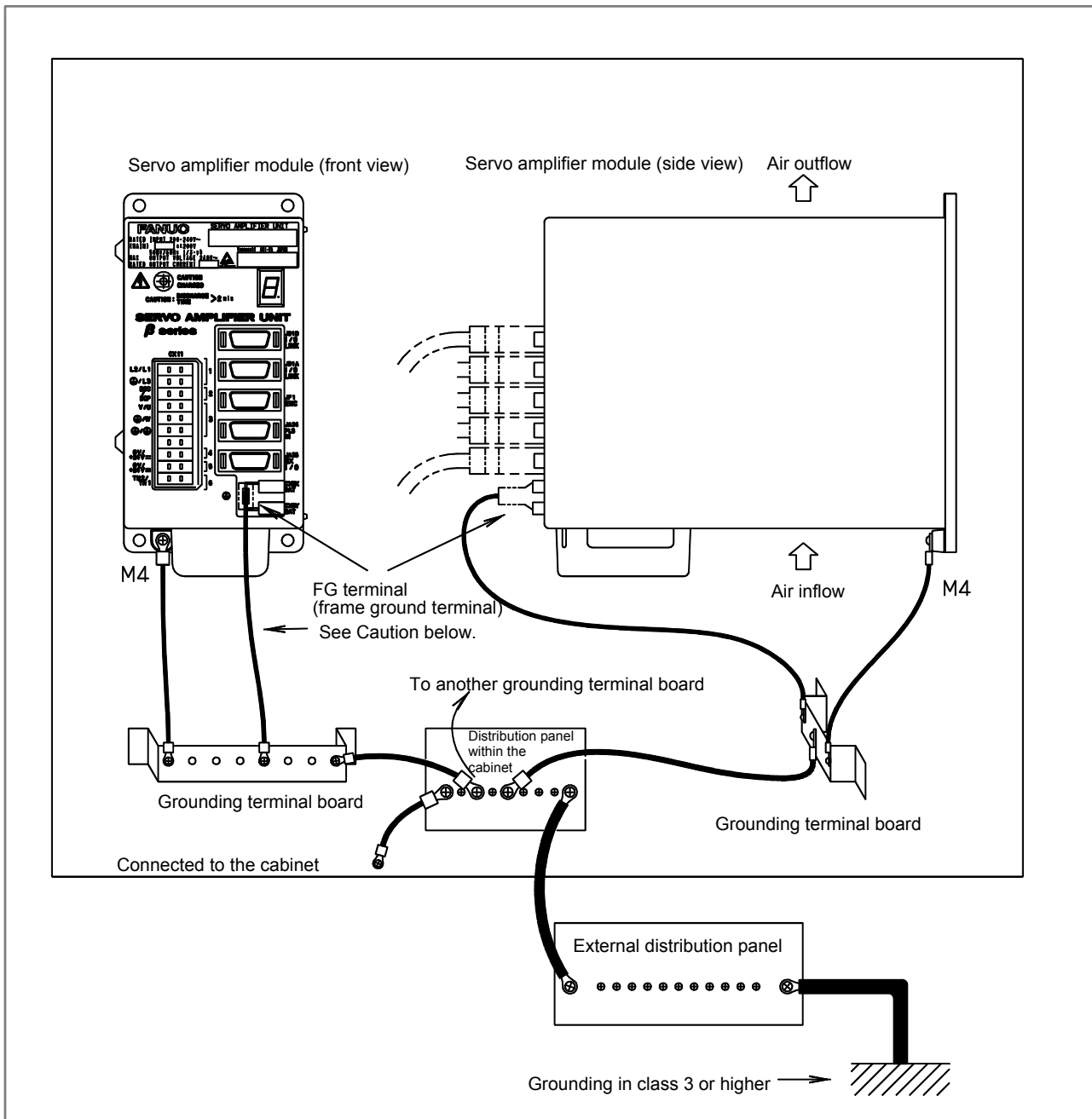

⚠ CAUTION
 Use the Faston terminals (A02B-0166-K330) for connection using the frame ground. Also connect to the grounding terminal board using 100 to 300 mm stranded wire with a cross-section of 2 mm² or more. Otherwise, the servo amplifier unit will be susceptible to noise.

- Noise suppressor

The AC/DC solenoid and relay are used in the power magnetics cabinet. A high pulse voltage is caused by coil inductance when these devices are turned on or off.

This pulse voltage induced through the cable causes the electronic circuits to be disturbed.

3.2 NOTES ON SELECTING THE SPARK KILLER

- Use a spark killer consisting of a resistor and capacitor in series. This type of spark killer is called a CR spark killer.(Use it under AC)
(A varistor is useful in clamping the peak voltage of the pulse voltage, but cannot suppress the sudden rise of the pulse voltage. FANUC therefore recommends a CR spark killer.)
- The reference capacitance and resistance of the spark killer shall conform to the following based on the current (I (A)) and DC resistance of the stationary coil:
 - ☐ Resistance (R) : Equivalent DC resistance of the coil
 - ☐ Capacitance (C) : $\frac{I^2}{10}$ to $\frac{I^2}{20}$ (μF)
where I : Current at stationary state of the coil

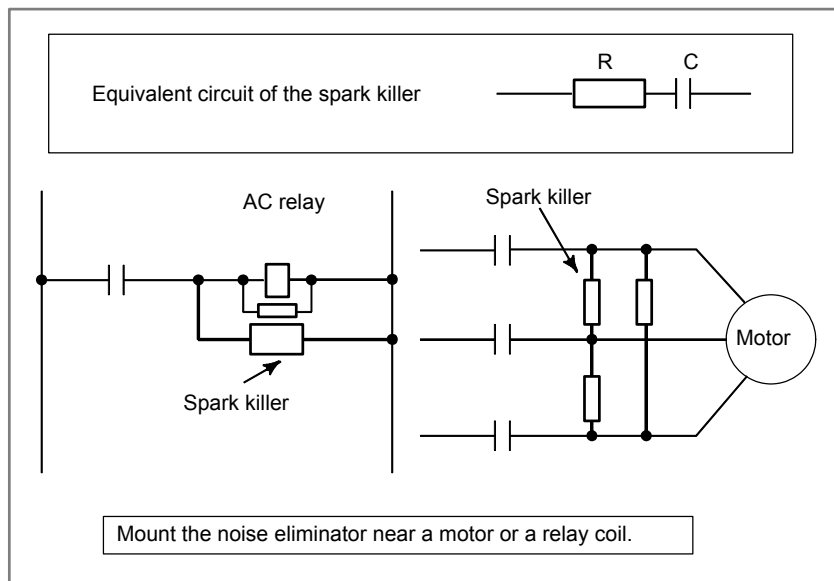

NOTE

Use a CR-type noise eliminator. Varistor-type noise eliminators clamp the peak pulse voltage but cannot suppress a sharp rising edge.

- Diode is used for direct-current circuits

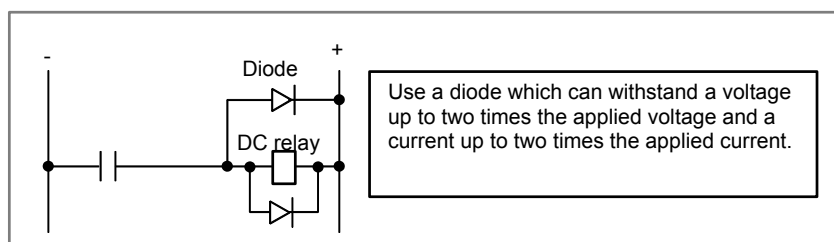

- Cable clamp and shield processing

The servo amplifier module cables that require shielding should be clamped by the method shown below. This cable clamp treatment is for both cable support and proper grounding of the shield. To insure stable CNC system operation, follow this cable clamp method.

Partially peel out the sheath and expose the shield. Push and clamp by the plate metal fittings for clamp at the part. The ground plate must be made by the machine tool builder, and set as follows :

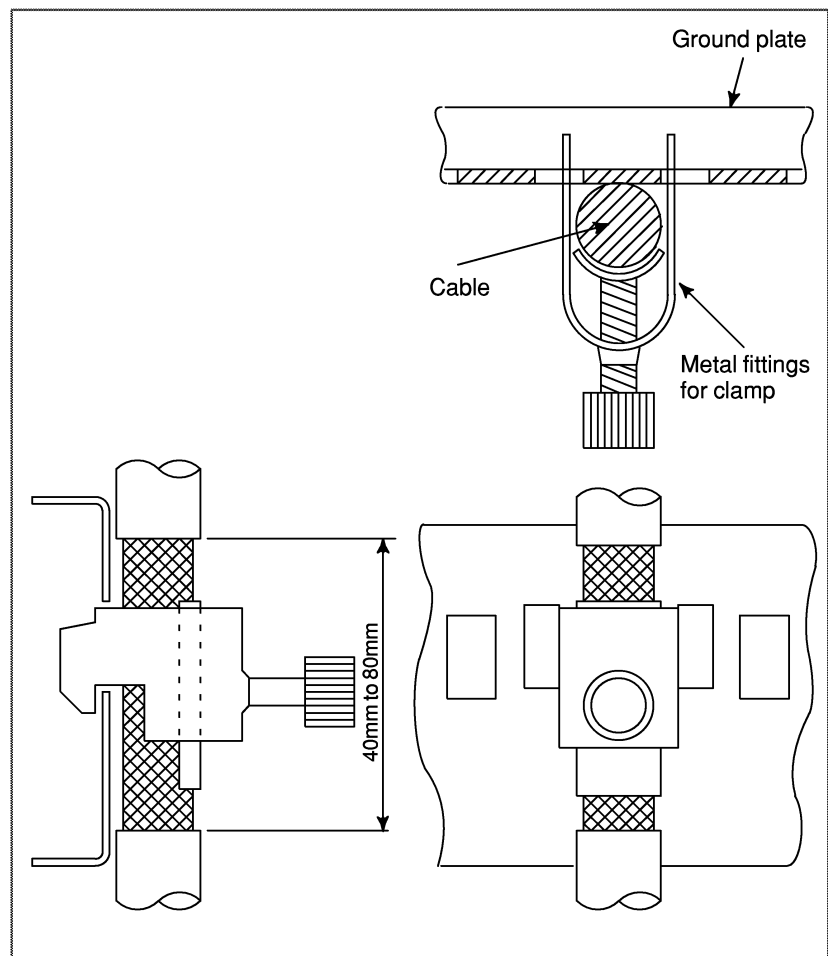

Cable clamp (1)

IV. MAINTENANCE OF SERVO AMPLIFIER MODULES

1

HOW TO REPLACE THE FUSES AND PRINTED CIRCUIT BOARDS



WARNING

Before replacing fuses or printed-circuit boards, make sure that the recharge-under-way LED (red) is off.

Before replacing fuses or printed circuit boards of servo amplifier modules, see the table given below to find which section or subsection in this manual provides information about the related replacement procedure.

NOTE

- 1 If a fuse blows, it is likely that there is a short-circuit in the power supply for a device (such as a sensor) connected to the servo amplifier module.
After checking that all devices connected to the servo amplifier are normal, replace the fuse.
If you do not remove the cause, it is very much likely that the fuse will blow again.
- 2 Do not use any fuse not supplied from FANUC.
- 3 Before replacing a fuse, check a marking on it with that on the printed-circuit board. Be careful not to mount a fuse with an incorrect rating.

1.1 HOW TO REPLACE THE FUSES AND PRINTED CIRCUIT BOARDS

A printed-circuit board can be removed and inserted from the front of the servo amplifier.

SVM1-4i, SVM1-20i

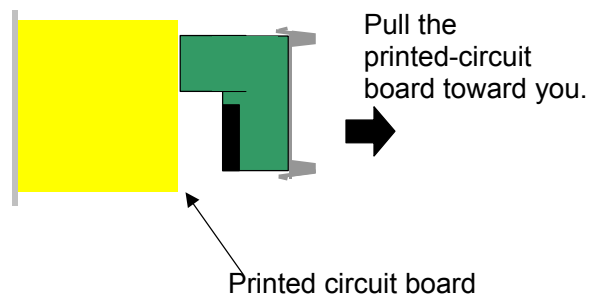
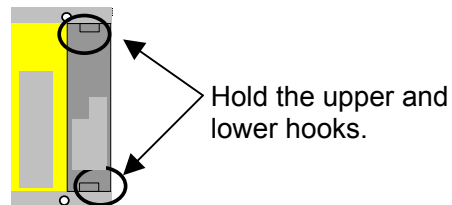

To insert the printed-circuit board, reverse the above procedure. Ensure that the upper and lower hooks snap into the housing. If the printed-circuit board is not inserted completely, the housing remains lifted. Pull out the printed-circuit board and insert it again.

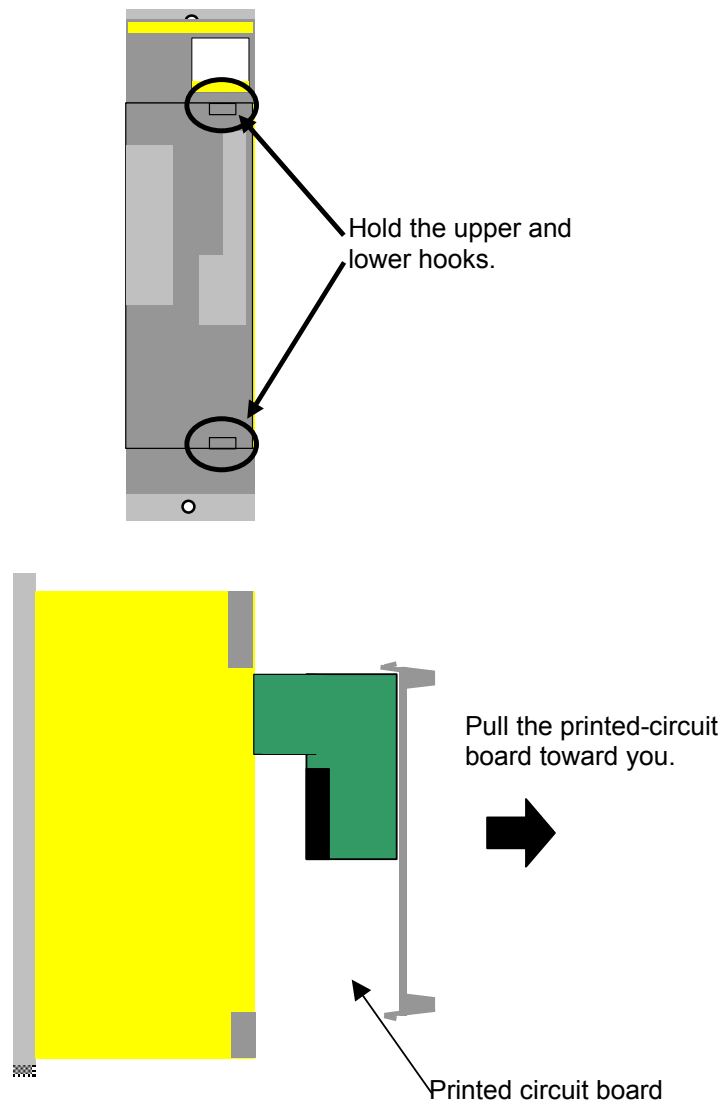
SVM1-40i, SVM1-80i

To insert the printed-circuit board, reverse the above procedure. Ensure that the upper and lower hooks snap into the housing. If the printed-circuit board is not inserted completely, the housing remains lifted. Pull out the printed-circuit board and insert it again.

1.1.1 Ordering Number of Printed Circuit Board

SVM

Model	Ordering number
SVM1-4 <i>i</i> to 20 <i>i</i>	A20B-8101-0200
SVM1-40 <i>i</i> to 80 <i>i</i>	

1.1.2 Fuse Locations

There is one fuse on the SVM printed-circuit board.

(1) A20B-8101-0200

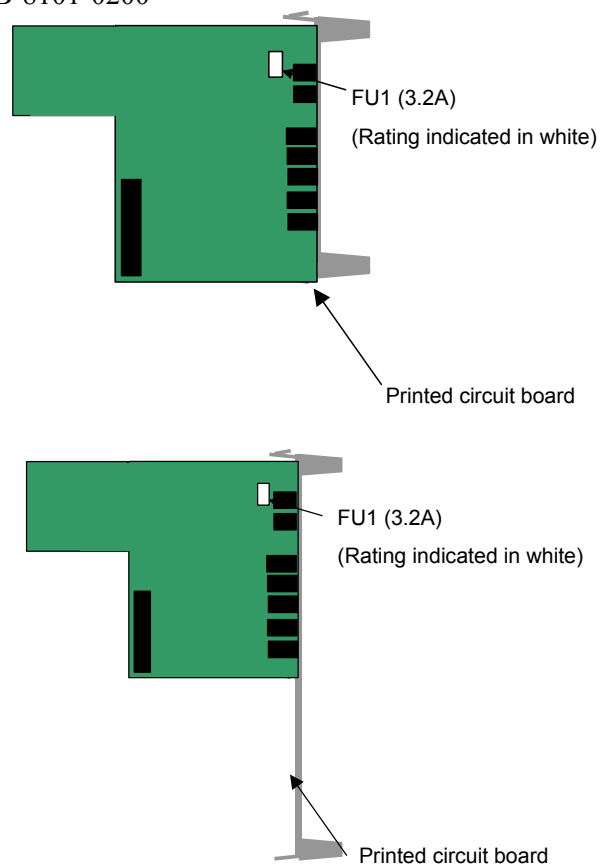

Fuse specification

Symbol	Ordering number
FU1	A60L-0001-0290#LM32C

1.2 HOW TO REPLACE THE FAN MOTOR

1.2.1 For Fan Motors for Internal Agitation for SVM1-4*i* and SVM1-20*i*

- <1> Pull out the fan connector upward.
- <2> Push the front of the fan unit to disengage the lug.
- <3> Disengage the rear of the fan unit.
- <4> Lift the fan unit in a slant direction.

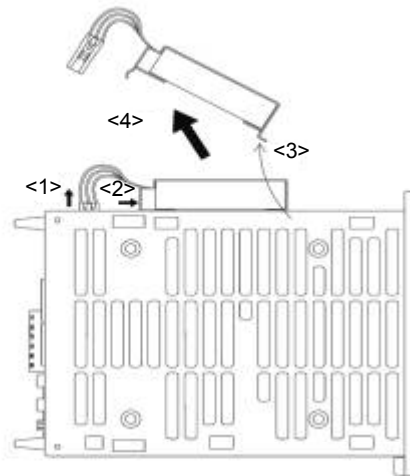

When replacing the fan motor, pay attention to its orientation and the cable drawing position.

Fan motor blow direction

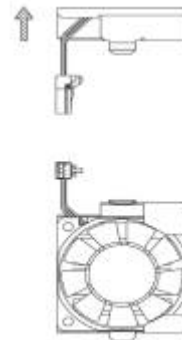

Fan unit

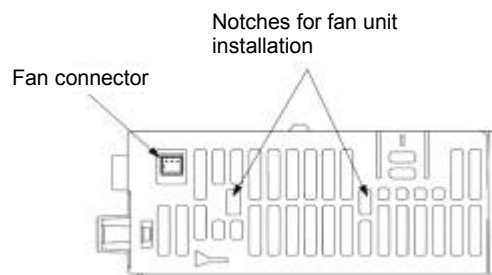

1.2.2 For Fan Motors for Internal Agitation for SVM1-40i and SVM1-80i

<1> Remove the four sheet metal fixing screws and then pull out the fan unit.

Holding the two lugs on the fan unit, lift the fan unit in the direction of the arrow (toward the top in the figure).

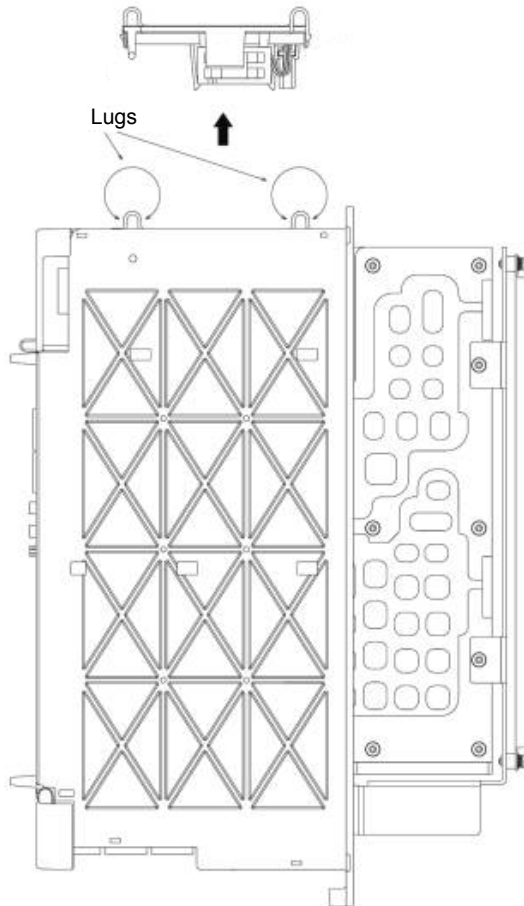

When replacing the fan motor, pay attention to its orientation and the orientation of the connector.

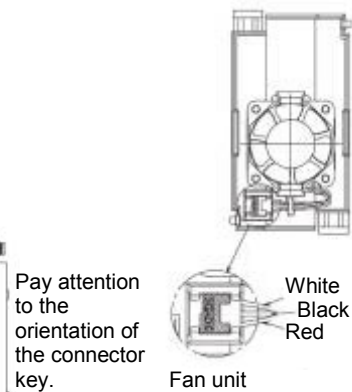

1.2.3 External-Fan Motor

<1> Holding the two lugs on the fan unit, lift the fan unit in the direction of the arrow (upward in the figure).

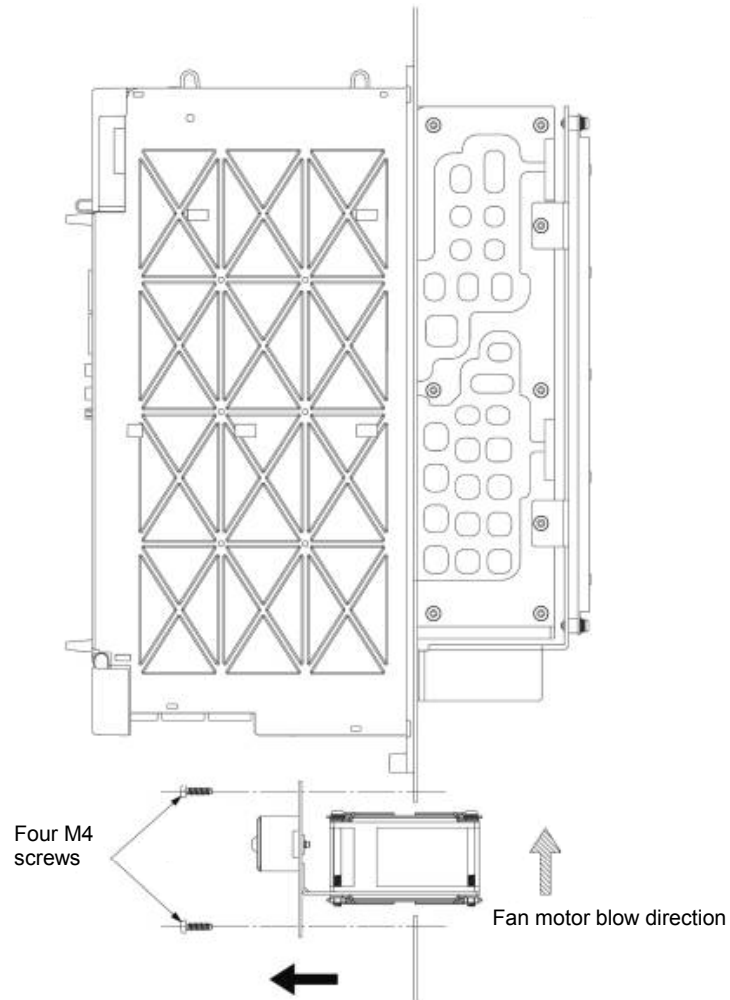

V. SERVO MOTOR MAINTENANCE

1

SERVO MOTOR MAINTENANCE

Generally, β is series AC servo motors have no parts that wear off or that must be replaced periodically, unlike DC servo motors, which have brushes that must be replaced periodically.

However, you should perform periodic maintenance for servo motors so as to keep their initial performance as long as possible and to prevent breakdowns. AC servo motors have precision sensors. Their incorrect use or damage caused during transportation or assembling can result in breakdowns or accidents. We recommend that you inspect the servo motors periodically according to the descriptions given below.

1.1 RECEIVING AND KEEPING AC SERVO MOTORS

When you receive an AC servo motor, make sure that:

- The motor is exactly the one you ordered, in terms of model, shaft, and sensor specifications.
- No damage has been caused on the motor.

Because FANUC inspects servo motors strictly before shipment, you do not, in principle, have to inspect them when you receive them.

The servo motors should be kept indoors as a rule. The storage temperature range is -20 to +60°C. Do not place or install AC servo motors in the place where:

- It is extremely humid and dew is prone to form,
- There is a steep change in temperature,
- There is constant vibration, which may cause damage to the shaft bearings, or
- There is lots of dust and trash.

1.2 DAILY INSPECTION OF AC SERVO MOTORS

Before starting operation, or periodically (once a week or month), you should inspect the AC servo motors in terms of the following:

(1) Vibration and noise

Check the motor for abnormal vibration (by the hand) and noise (by the ear) when the motor is:

- Not rotating
- Rotating at low speed
- Accelerating or decelerating

If you find anything unusual, contact your FANUC service staff.

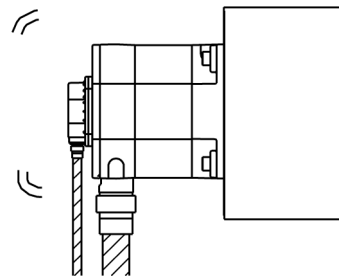

(2) Damage on the outside

Check the Pulsecoder cover (red plastic) for crevices and the motor surface (black coating) for scratches and cracks.

If you find a crevice in the Pulsecoder cover, you should replace it. For how to replace, see the description about the Pulsecoder in Section 1.4. If you are not sure about replacement, contact you FANUC service staff.

If there is a scratch or crack on the motor surface, the user should repair it by himself as required. If coating has come off, dry the portion of interest (or the entire surface) and coat it with paint for machines such as urethane paint.

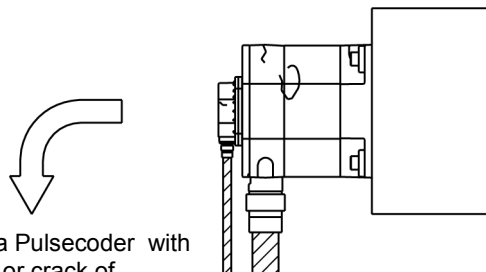

Replace a Pulsecoder with a crevice or crack of Pulsecoder cover

(3) Stains and smudges

Check the motor surface and bolt holes for oil or coolant.

Wipe off oil and coolant on the motor surface periodically. Oil or coolant can damage the coating by chemical reaction, possibly leading to a failure.

Also check how such a liquid leaks onto the motor, and repair if needed.

Wipe off oil and coolant on the motor surface periodically.

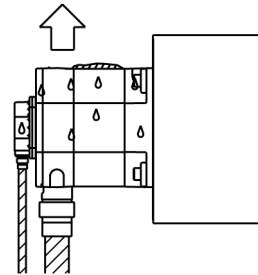

(4) Overheating

Check to see if the motor is too hot during normal operation.

Attach a thermolabel on the motor surface and check it visually to see if the motor becomes too hot during normal operation.



CAUTION

Temperature on the motor surface can exceed 80°C under some conditions. Never touch it by the hand.

Attach a thermolabel and check it visually.

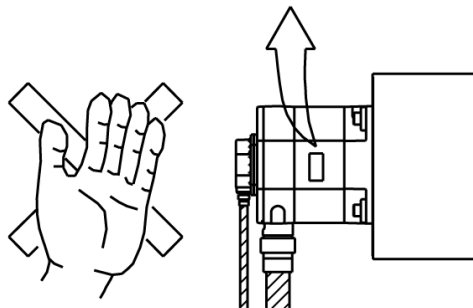

1.3 PERIODIC INSPECTION OF AC SERVO MOTORS

We recommend that you inspect the AC servo motors for the following items at least once a year.

(1) Observation of torque command (TCMD) and speed command (VCMD) waveforms

Observe normal voltage waveforms with an oscilloscope, and keep notes of them. During periodic inspection, check the current waveforms with the records.

The waveforms vary according to the operating conditions such as load and cutting speed. Note that you should make comparisons under the same condition (for example, during fast traverse to the reference position or low-speed cutting).

For a description of the measurement method, see Appendix E, "SERVO CHECK BOARD".

(2) Diagnosis by waveforms

Check the measured waveforms to see whether:

<1> The peak current is within the limit to the current in the amplifier during rapid traverse, acceleration, or deceleration.(TCMD)

The limit to the amplifier current is listed below. A voltage of 4.44 V is indicated when the current flowing through the amplifier is equal to the current limit for the amplifier (common to all models).

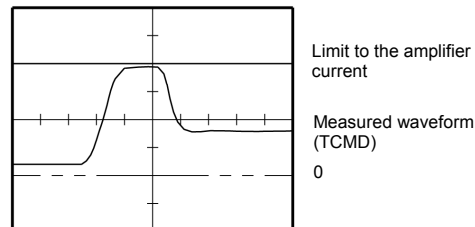

⇒ The motor used to accelerate/decelerate with the amplifier current within the limit (the acceleration/deceleration torque used to be sufficient), but something is wrong now. If this is the case, the probable causes are:

- The load conditions in the machine have changed because of changed friction or reduced machine efficiency after long period of use.
- Motor failure

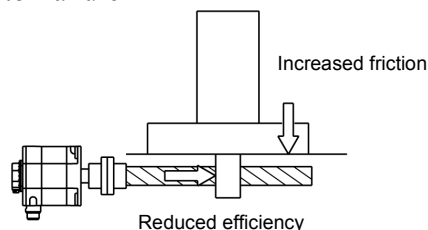

[Table 1]

Models	Current value
$\beta 0.2/5000is$, $\beta 0.3/5000is$	4Ap
$\beta 0.4/5000is$, $\beta 0.5/5000is$, $\beta 1/5000is$, $\beta 2/4000is$, $\beta 4/4000is$, $\beta 8/3000is$	20Ap
$\beta 12/3000is$, $\beta 22/2000is$	40Ap

<2> The waveform has ripple during constant-speed feeding (VCMD).

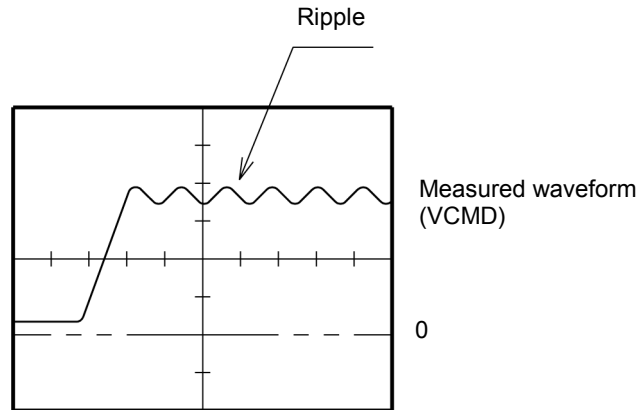

<3> The current waveform has ripple or jumps when the motor is not rotating (VCMD).

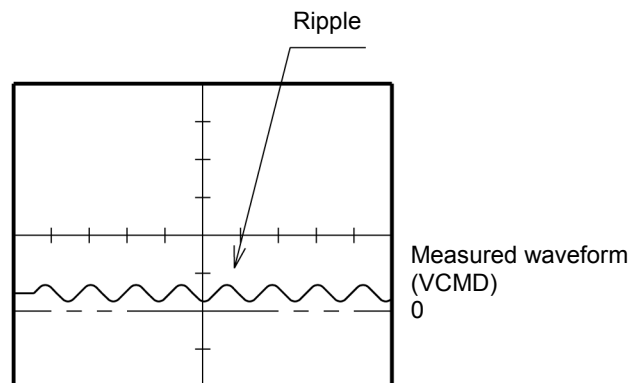

If you find anything unusual in relation to the above items <1> to <3>, contact your FANUC service staff.

(3) Winding and insulation resistances.

Measure check its winding and insulation resistances.

Note that extremely severe inspections (such as dielectric strength tests) of a motor may damage its windings. For the winding resistances of motors, refer to FANUC AC SERVO MOTOR βis series Descriptions (B-65302EN), or ask FANUC. For insulation resistances, see the following table.

MOTOR INSULATION RESISTANCE MEASUREMENT

Measure an insulation resistance between each winding and motor frame using an insulation resistance meter (500 VDC).

Judge the measurements according to the following table.

Insulation resistance	Judgment
100M Ω or higher	Acceptable
10 to 100 M Ω	The winding has begun deteriorating. There is no problem with the performance at present. Be sure to perform periodic inspection.
1 to 10 M Ω	The winding has considerably deteriorated. Special care is in need. Be sure to perform periodic inspection.
Lower than 1 M Ω	Unacceptable. Replace the motor.

NOTE

If the insulation resistance steeply drops within a short period of time, it is likely that liquid such as coolant may have entered from the outside. Check the drip-proof environment again (by referring to Section 2.1, "USE ENVIRONMENT FOR SERVO MOTORS," in Chapter I in "FANUC AC SERVO MOTOR β is series Descriptions (B-65302EN)).

1.4 REPLACING THE PULSECODER

This section explains how to replace the Pulsecoder and motor cover, assuming that the Pulsecoder has broken down and is in need of immediate replacement.

When replacing the Pulsecoder and motor cover, be careful not to give a shock to the Pulsecoder or motor, because they are precision devices prone to a breakdown. Also keep them from dust and cutting chips.

- <1> Remove the four M4 hexagonal socket head bolts that fasten the Pulsecoder. Do not loosen the M3 bolts near each M4 bolt.

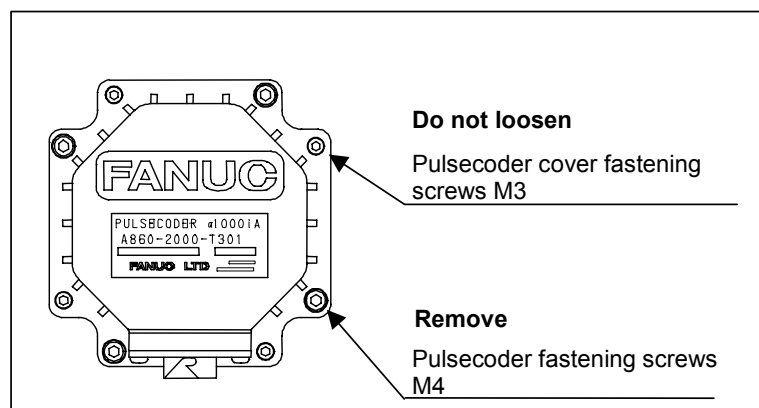

- <2> Remove the Pulsecoder and Oldham's coupling.

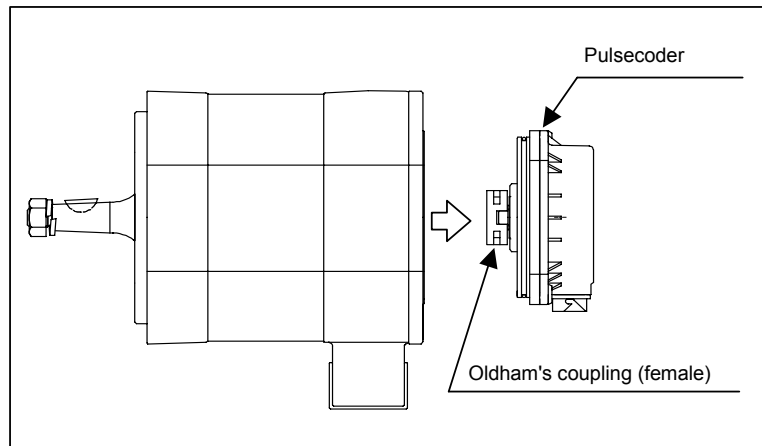

- <3> Set a new Pulsecoder and a new Oldham's coupling in the motor. Place the Oldham's coupling with the correct orientation, and engage the teeth. Push in the Pulsecoder until the O ring on the Pulsecoder settles in between the motor pocket and Pulsecoder pocket. Be careful not allow the O ring to be caught between other parts.

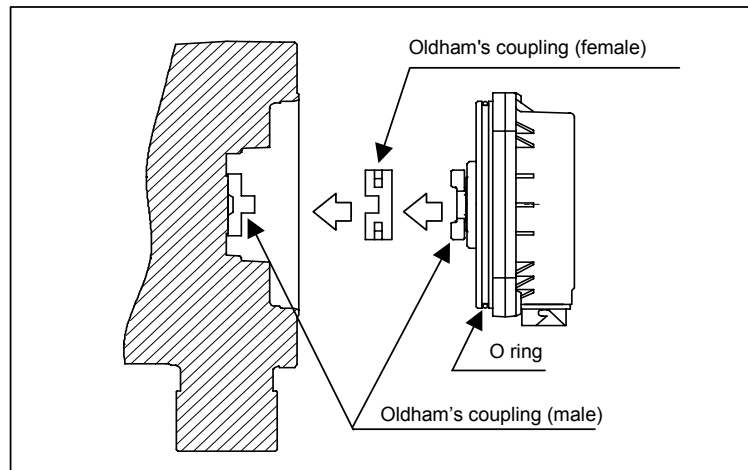

- <4> Fasten the Pulsecoder with the four M4 hexagonal socket head bolts.

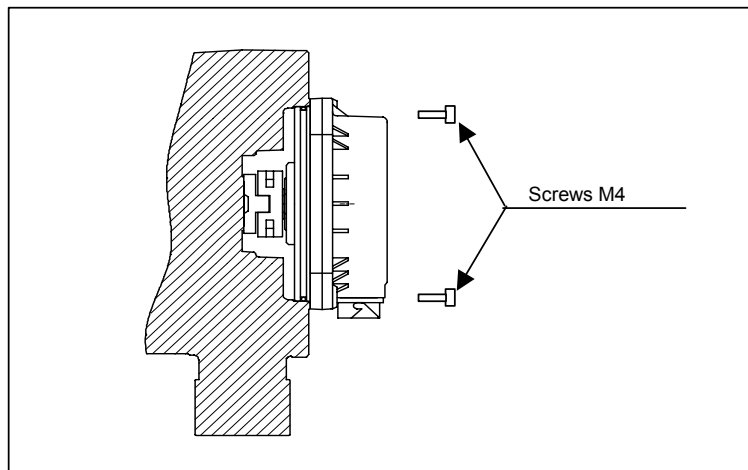

1.5 SPECIFICATION NUMBERS OF REPLACEMENT PARTS

The following lists the ordering specification numbers for maintenance:

- (1) Ordering specifications of Pulsecoders
A860-2020-T301: $\beta 128iA$

- (2) Oldham's coupling
A290-0501-V535

APPENDIX

A

SERVO AMPLIFIER MODULE FRONT VIEW

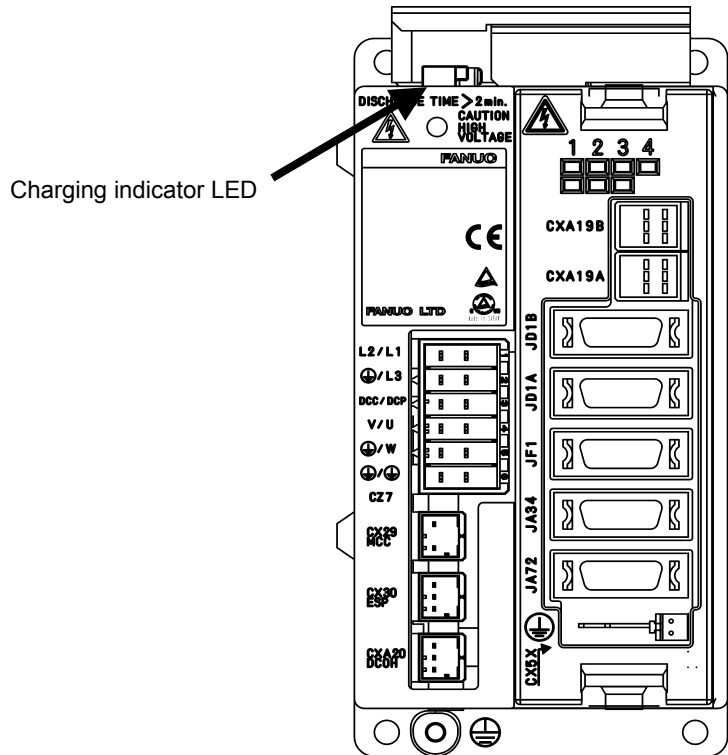

Fig. A(a) SVM-4i, SVM-20i

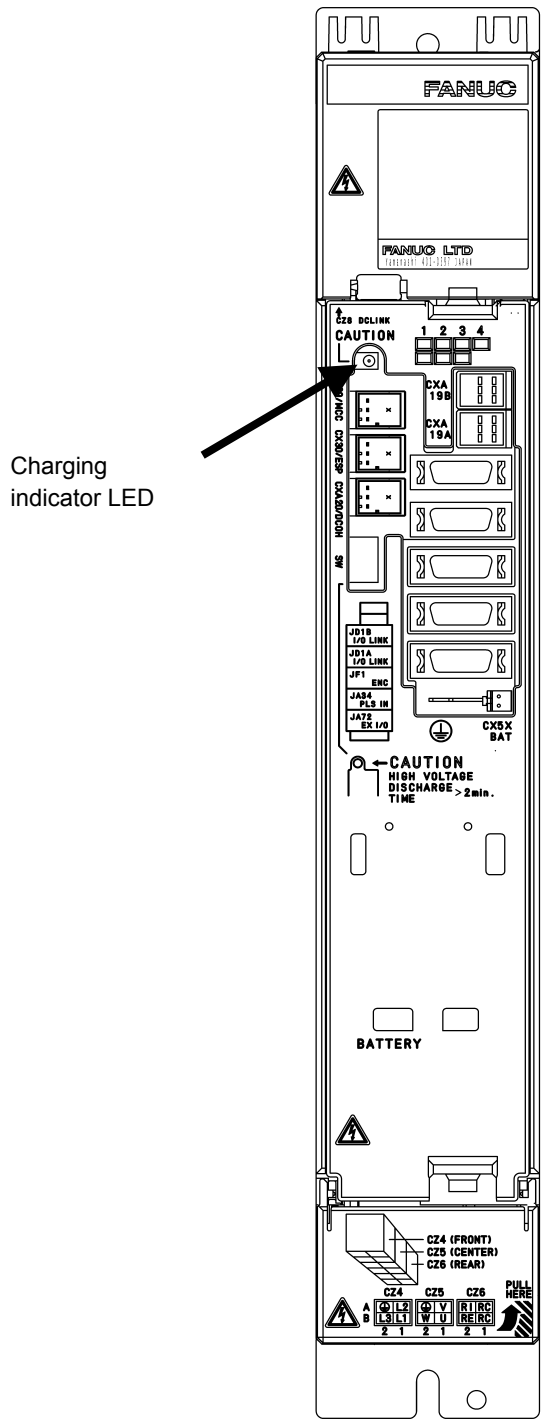

Fig. A(b) SVU-40i, SVU-80i

B

PARAMETER LIST

Table B (a) Parameter list (in order of classification)

Classification	Parameter number	Reference item
Controlled-axis parameter	000	B.1
Coordinate system and stroke limit parameters	001, 068, 140 to 145, 147, 154 to 165, 170	B.2
Feedrate parameters	021, 040, 041, 043 to 050, 054, 061, 066, 067	B.3
Acceleration/deceleration parameters	002, 055 to 060	B.4
Input/output signal parameters	003 to 005, 007, 020, 022 to 025, 029, 062, 063, 148 to 152, 166 to 169	B.5
Servo parameters	010 to 014, 016 to 019, 030 to 032, 070 to 075, 078 to 096, 099 to 112, 115, 116, 118, 119, 125, 130, 135 to 138, 179 to 182	B.6

Table B (a) Parameter list (in order of parameter number)

Any parameter with its number column shaded is automatically set by setting bit 0 of parameter No. 012 to 0, then turning the power off and then back on.

No.	Description	Related item															
000	Controlled-axis #1 ROTX : Linear axis (0)/Rotation axis (1) #2 RAB2X : Specification of the sign of the absolute command-based rotation direction of the rotation axis is disabled (0)/enabled (1). #6 RABX : The absolute command-based rotation direction of the rotation axis is a direction in which the distance to a desired point within one revolution is smaller (0)/a direction determined according to a command-specified sign (1). #7 ROAX : The roll-over function of the rotation axis is disabled (0)/enabled (1).	Appendix B.1															
001	Coordinate system and stroke limit #1 ZRTN : If a reference position is not set up, an alarm is issued (0)/not issued (1). #2 HOT : The overtravel direct input signals are disabled (0)/enabled (1). #3 SSL1 : Stored stroke limit 1 is invalid (0)/valid (1). #4 N405 : If reference position return cannot be executed correctly, servo alarm No. 405 is issued (0)/not issued (1). #6 EPEXA #7 EPEXB : If input external pulses exceed the upper limit for feedrate commands: <table border="1" style="margin-left: 40px;"> <thead> <tr> <th>EPEXB</th> <th>EPEXA</th> <th>Description</th> </tr> </thead> <tbody> <tr> <td>0</td> <td>0</td> <td>The feedrate is clamped (pulses at excessive rates are accumulated).</td> </tr> <tr> <td>0</td> <td>1</td> <td>Alarm No. 291</td> </tr> <tr> <td>1</td> <td>0</td> <td>The feedrate is clamped (pulses at excessive rates are discarded).</td> </tr> <tr> <td>1</td> <td>1</td> <td>Alarm No. 291</td> </tr> </tbody> </table>	EPEXB	EPEXA	Description	0	0	The feedrate is clamped (pulses at excessive rates are accumulated).	0	1	Alarm No. 291	1	0	The feedrate is clamped (pulses at excessive rates are discarded).	1	1	Alarm No. 291	Appendix B.2
EPEXB	EPEXA	Description															
0	0	The feedrate is clamped (pulses at excessive rates are accumulated).															
0	1	Alarm No. 291															
1	0	The feedrate is clamped (pulses at excessive rates are discarded).															
1	1	Alarm No. 291															
002	Acceleration/deceleration control #0 RPDE : The acceleration/deceleration type for rapid traverse is linear or bell-shaped (0)/exponential (1). #1 JOGE : The acceleration/deceleration type for jog or cutting feed is linear or bell-shaped (0)/exponential (1). #3 CIPC : Switching between effective areas for in-position check is disabled (0)/enabled (1). #6 RVF2 : For a rapid traverse override, a feedrate is specified in 4 steps of 100%, 50%, 25%, F0 (0)/100%, F1, F2, F0 (1). #7 CSMZ : The SMZX signal is disabled (0)/enabled (1).	Appendix B.4															
003	Input/output signals #1 NCLP : Clamping/unclamping is used (0)/not used (1). #2 IGCP : A clamp/unclamp state is checked (0)/ not checked (1). #5 WAT2 : For a wait command, an ID code cannot be specified (0)/can be specified (1). #6 EXPLS : The external pulse function is disabled (0)/enabled (1). #7 STON : The ST signal is detected on the falling edge (0)/rising edge (1).	Appendix B.5															
004	Input/output signals #2 ZRNO : Input of a reference position establishment signal is disabled (0)/enabled (1). #3 NEPRM : Writing to EEPROM is performed (0)/not performed (1).	Appendix B.5															

No.	Description	Related item
005	Input/output signals	Appendix B.5
	#0 JNCL : When JOG operation stops, clamping is performed (0)/not performed (1).	
	#1 CLPSVF : The time from clamping to servo-off is set as the time from the point the UCPC2 signal turns off (0)/the time from the point the UCPS2 signal turns off (1).	
	#2 REFDR : The direction of high-speed reference position return of the rotation axis depends on the sign of the result of subtracting the current position from the reference position (0)/the setting of bit 5 (ZMIX) of parameter No.010 (1).	
	#4 IOH : Manual handle feed over the I/O Link is disabled (0)/enabled (1).	
	#5 MP : Setting of a magnification in 4 steps with the MP1/MP2 signal for manual handle feed is disabled (0)/enabled (1).	
	#6 LDM : Output of the motor current value to response data is disabled (0)/enabled (1).	
	#7 ABSPS : Reading of response data is not synchronized with the host (0)/synchronized with the host (1).	
007	Input/output signals	Appendix B.5
	#0 ABSV : When coordinates are read, allowance for delays including an acceleration/deceleration delay and servo delay is not made (0)/made (1).	
	#1 PSSV : For area signals, allowance for delays including an acceleration/deceleration delay and servo delay is not made (0)/made (1).	
	#2 NZRPO: If a reference position is not established, a turret/magazine number or point number is not output (0)/output (1).	
	#4 VCTLB : The velocity control type for peripheral equipment control is type A (0)/type B(1).	
	#5 ATCR2 : A turret/magazine number is not always output to response data (0)/always output to response data (1).	
010	Servo	Appendix B.6
	#0 IINP : When the torque is limited, an in-position check is not made (0)/made (1).	
	#1 IALM : When the torque is limited, a check for an excessive error is not made (0)/made (1).	
	#2 IEBL : The torque limit function is disabled (0)/enabled (1).	
	#5 ZMIX : The initial direction of reference position return and backlash is positive (0)/negative (1).	
	#6 ECMR : CMR expansion is disabled (0)/enabled (1).	
	#7 SVFP : During servo-off, follow-up is not performed (0)/performed (1).	
011	Servo	Appendix B.6
	#0 ABSX : The reference position of the absolute-position detector has not been established (0)/has been established (1).	
	#1 SZRN : Scale return is disabled (0)/enabled (1).	
	#2 DZRN : Reference position return with dogs is disabled (0)/enabled (1).	
	#6 MVZPFR : When the reference position on a rotation axis is updated, allowance for a fraction is not made (0)/made (1).	
	#7 APCX : An absolute-position detector is not provided (0)/provided (1).	
012	Servo	Appendix B.6
	#1 DGPR : Automatic motor settings are made (0)/not made (1).	

No.	Description	Related item																												
013	Servo	Appendix B.6																												
	#0 VCM1 #1 VCM2 : The scale of VCMD output to the check board <table border="1" style="margin-left: 20px;"> <thead> <tr> <th>VCM2</th> <th>VCM1</th> <th>Scale</th> </tr> </thead> <tbody> <tr> <td>0</td> <td>0</td> <td>5 V corresponds to 3750 min⁻¹.</td> </tr> <tr> <td>0</td> <td>1</td> <td>5 V corresponds to 234 min⁻¹.</td> </tr> <tr> <td>1</td> <td>0</td> <td>5 V corresponds to 14.6 min⁻¹.</td> </tr> <tr> <td>1</td> <td>1</td> <td>5 V corresponds to 0.92 min⁻¹.</td> </tr> </tbody> </table> #4 TSA1 #5 TSA2 : The scale of TSA output to the check board <table border="1" style="margin-left: 20px;"> <thead> <tr> <th>TSA2</th> <th>TSA1</th> <th>Scale</th> </tr> </thead> <tbody> <tr> <td>0</td> <td>0</td> <td>5 V corresponds to 3750 min⁻¹.</td> </tr> <tr> <td>0</td> <td>1</td> <td>5 V corresponds to 234 min⁻¹.</td> </tr> <tr> <td>1</td> <td>0</td> <td>5 V corresponds to 14.6 min⁻¹.</td> </tr> <tr> <td>1</td> <td>1</td> <td>5 V corresponds to 0.92 min⁻¹.</td> </tr> </tbody> </table>		VCM2	VCM1	Scale	0	0	5 V corresponds to 3750 min ⁻¹ .	0	1	5 V corresponds to 234 min ⁻¹ .	1	0	5 V corresponds to 14.6 min ⁻¹ .	1	1	5 V corresponds to 0.92 min ⁻¹ .	TSA2	TSA1	Scale	0	0	5 V corresponds to 3750 min ⁻¹ .	0	1	5 V corresponds to 234 min ⁻¹ .	1	0	5 V corresponds to 14.6 min ⁻¹ .	1
VCM2	VCM1	Scale																												
0	0	5 V corresponds to 3750 min ⁻¹ .																												
0	1	5 V corresponds to 234 min ⁻¹ .																												
1	0	5 V corresponds to 14.6 min ⁻¹ .																												
1	1	5 V corresponds to 0.92 min ⁻¹ .																												
TSA2	TSA1	Scale																												
0	0	5 V corresponds to 3750 min ⁻¹ .																												
0	1	5 V corresponds to 234 min ⁻¹ .																												
1	0	5 V corresponds to 14.6 min ⁻¹ .																												
1	1	5 V corresponds to 0.92 min ⁻¹ .																												
014	Servo	Appendix B.6																												
	#0 IRS : Items output to DATA0 and DATA1 of the check board are changed to VCMD, TCMD (0)/IR, IS (1). Bit 1 (TDOU) of parameter No.014 must be set to 0. #1 TDOU : Items output to DATA0 and DATA1 of the check board are changed to VCMD, TCMD (0)/specified acceleration, estimated load torque (1). Bit 0 (IRS) of parameter No.014 must be set to 0.																													
016	Servo	Appendix B.6																												
	#0 PIIP : The velocity loop is subjected to PI control (0)/IP control (1). #1 LVMD : Low-velocity integration is disabled (0)/enabled (1). #4 FFVL : <table border="1" style="margin-left: 20px;"> <thead> <tr> <th>FFVL</th> <th>FFAL</th> <th>Description</th> </tr> </thead> <tbody> <tr> <td>1</td> <td>1</td> <td>The feed-forward function is enabled.</td> </tr> <tr> <td>0</td> <td>*</td> <td>The feed-forward function is disabled.</td> </tr> <tr> <td>1</td> <td>0</td> <td>The feed-forward function is disabled.</td> </tr> </tbody> </table> #5 FFAL :		FFVL	FFAL	Description	1	1	The feed-forward function is enabled.	0	*	The feed-forward function is disabled.	1	0	The feed-forward function is disabled.																
FFVL	FFAL	Description																												
1	1	The feed-forward function is enabled.																												
0	*	The feed-forward function is disabled.																												
1	0	The feed-forward function is disabled.																												
017	Servo	Appendix B.6																												
	#0 HENB : The skip function is disabled (0)/enabled (1). #1 HEDG : A skip signal is detected on the rising edge (0)/falling edge (1). #2 SPCO : If no skip signal is input and the end point is reached, skip measurement data is not updated (0)/contains end point data (1).																													
018	Servo	Appendix B.6																												
	#2 VCMD0: The function for quick stop at emergency stop is disabled (0)/enabled (1). #3 TIM0 #4 TIM1 : MCC off timer settings <table border="1" style="margin-left: 20px;"> <thead> <tr> <th>TIM1</th> <th>TIM0</th> <th>MCC off timer</th> </tr> </thead> <tbody> <tr> <td>0</td> <td>0</td> <td>0 ms</td> </tr> <tr> <td>1</td> <td>0</td> <td>60 ms</td> </tr> <tr> <td>1</td> <td>1</td> <td>100 ms</td> </tr> </tbody> </table>		TIM1	TIM0	MCC off timer	0	0	0 ms	1	0	60 ms	1	1	100 ms																
TIM1	TIM0	MCC off timer																												
0	0	0 ms																												
1	0	60 ms																												
1	1	100 ms																												
019	Servo	Appendix B.6																												
	#2 ACLIM : Current compensation function 11 is disabled (0)/enabled (1). #3 SQLIM : Current compensation function 12 is disabled (0)/enabled (1).																													
020	Response data specification	Appendix B.5																												
021	Feedrate command weight N	Appendix B.3																												
022	ECF and EBSY signal minimum output time	Appendix B.5																												
023	PMM allocation rate assumed when reading continuous data with a direct command	Appendix B.5																												

No.	Description	Related item
024	Axis name (1st character)	Appendix B.5
025	Axis name (2nd character)	Appendix B.5
029	Internal variable (ignore this parameter)	Appendix B.5
030	Set 0. Set the motor type number in parameter No. 125.	
031	Direction of motor rotation (DIRCTL)	Appendix B.6
032	Command multiplier (CMR)	Appendix B.6
036	Always set 0.	
037	Always set 0.	
038	Always set 0.	
039	Always set 0.	
040	Rapid traverse rate	Appendix B.3
041	Jog feedrate	Appendix B.3
043	Feedrate upper limit	Appendix B.3
044	Feedrate specified for feedrate code 1	Appendix B.3
045	Feedrate specified for feedrate code 2	Appendix B.3
046	Feedrate specified for feedrate code 3	Appendix B.3
047	Feedrate specified for feedrate code 4	Appendix B.3
048	Feedrate specified for feedrate code 5	Appendix B.3
049	Feedrate specified for feedrate code 6	Appendix B.3
050	Feedrate specified for feedrate code 7	Appendix B.3
054	FL rate for a reference position return	Appendix B.3
055	Linear/bell-shaped/exponential acceleration/deceleration time constant T1 for rapid traverse	Appendix B.4
056	Rapid traverse bell-shaped acceleration/deceleration time constant T2	Appendix B.4
057	Linear/bell-shaped/exponential acceleration/deceleration time constant T1 for jog or cutting feed	Appendix B.4
058	Bell-shaped acceleration/deceleration time constant T2 for jog or cutting feed	Appendix B.4
059	Exponential acceleration/deceleration FL rate for jog or cutting feed	Appendix B.4
060	FL rate for rapid traverse exponential acceleration/deceleration	Appendix B.4
061	F0 rate for rapid traverse override	Appendix B.3
062	External pulse input-based axis movement amount ratio setting 1 (M)	Appendix B.5
063	External pulse input-based axis movement amount ratio setting 2 (N)	Appendix B.5
066	F1 rate for rapid traverse override	Appendix B.3
067	F2 rate for rapid traverse override	Appendix B.3
068	Number of magazines/turrets	Appendix B.2
070	Current loop gain (PK1)	Appendix B.6
071	Current loop gain (PK2)	Appendix B.6
072	Current loop gain (PK3)	Appendix B.6
073	Velocity loop gain (PK1V)	Appendix B.6
074	Velocity loop gain (PK2V)	Appendix B.6
075	Velocity loop gain (PK4V)	Appendix B.6
078	Current compensation 1 (PVPA)	Appendix B.6
079	Current compensation 2 (PALPH)	Appendix B.6
080	Current limit value (TQLIM)	Appendix B.6
081	Overload protection coefficient (POVC1)	Appendix B.6
082	Overload protection coefficient (POVC2)	Appendix B.6
083	Overload protection coefficient (POVCLM)	Appendix B.6
084	Current compensation 3 (AALPH)	Appendix B.6
085	Actual current limit (DBLIM)	Appendix B.6
086	Current compensation 4 (MGSTCM)	Appendix B.6
087	Current compensation 5 (DETQLM)	Appendix B.6

No.	Description	Related item
088	Current compensation 6 (NINTCT)	Appendix B.6
089	Current compensation 7 (MFWKCE)	Appendix B.6
090	Current compensation 8 (MFWKBL)	Appendix B.6
091	VCMD polyline speed (P_VCLN)	Appendix B.6
092	Low-speed integration threshold speed (P_LVIN)	Appendix B.6
093	Estimated load torque: torque offset (TCPRLD)	Appendix B.6, II 6
094	Estimated load torque: dynamic friction compensation (FRCCMP)	Appendix B.6, II 6
095	Unexpected disturbance torque detection: retract distance (ABVOF)	Appendix B.6, II 6
096	Unexpected disturbance torque detection: alarm threshold (ABTSH)	Appendix B.6, II 6
099	Current compensation 9 (EMFCMP)	Appendix B.6
100	Load inertia ratio (LDINT)	Appendix B.6
101	Acceleration feedback (PK2VAUX)	Appendix B.6
102	Torque command filter (FILTER)	Appendix B.6
103	Feed-forward coefficient (FALPH)	Appendix B.6
104	Velocity feed-forward coefficient (VFFLT)	Appendix B.6
105	Numerator for the number of pulses per motor revolution (SDMR1)	Appendix B.6
106	Denominator for the number of pulses per motor revolution (SDMR2)	Appendix B.6
107	Position loop gain (LPGINX)	Appendix B.6
108	Servo motor torque limit	Appendix B.6
109	Backlash amount (BKLCMP)	Appendix B.6
110	Positional deviation limit value at a stop	Appendix B.6
111	In-position width	Appendix B.6
112	Torque constant	
115	Model constant	
116	Velocity loop gain override during velocity control	Appendix B.6
118	Current compensation 10 (PHDLY1)	Appendix B.6
119	Current compensation 10 (PHDLY2)	Appendix B.6
125	Motor type number	Appendix B.6
130	Unexpected disturbance torque detection alarm timer	Appendix B.6, II 6
135	Linear acceleration/deceleration time constant for velocity control	Appendix B.6
136	Velocity deviation check limit during velocity control	Appendix B.6
137	Effective area for in-position check during cutting feed	Appendix B.6
138	Expanded CMR	Appendix B.6
140	Machine coordinate for the reference position	Appendix B.2
141	Amount of movement per rotation axis revolution	Appendix B.2
142	Positive machine coordinate for stored stroke limit 1	Appendix B.2
143	Negative machine coordinate for stored stroke limit 1	Appendix B.2
144	Machine coordinate for the second reference position	Appendix B.2
145	Machine coordinate for the third reference position	Appendix B.2
147	Workpiece coordinate for the reference position	Appendix B.2
148	Servo positional deviation monitor amount	Appendix B.5
149	Remaining travel limit for outputting the remaining travel in-range signal (DEN2)	Appendix B.5
150	Coordinates (minimum) for point 1 in the operation range of the area signals	Appendix B.5
151	Coordinates for point 2 in the operation range of the area signals	Appendix B.5
152	Coordinates for point 3 in the operation range of the area signals	Appendix B.5
154	Position for point number 1	Appendix B.2
155	Position for point number 2	Appendix B.2
156	Position for point number 3	Appendix B.2
157	Position for point number 4	Appendix B.2
158	Position for point number 5	Appendix B.2
159	Position for point number 6	Appendix B.2

No.	Description	Related item
160	Position for point number 7	Appendix B.2
161	Position for point number 8	Appendix B.2
162	Position for point number 9	Appendix B.2
163	Position for point number 10	Appendix B.2
164	Position for point number 11	Appendix B.2
165	Position for point number 12	Appendix B.2
166	Operation completion signal output time	Appendix B.5
167	Time between servo-on and unclamping	Appendix B.5
168	Time between clamping and servo-off	Appendix B.5
169	Time allowed before the next sequence is executed without clamping/unclamping	Appendix B.5
170	Index point tolerance	Appendix B.2
179	Numerator for the number of pulses per motor revolution (SDMR1, 32768 or greater)	Appendix B.6
180	Reference counter capacity	Appendix B.6
181	Grid shift amount	Appendix B.6
182	Positional deviation limit value during movement	Appendix B.6

**CAUTION**

You must not change any parameters during operation.

NOTE

- 1 The increment system in the current CNCs corresponds to the user-specified unit in this servo amplifier module. For example, when an amount of movement is specified in any of the current CNCs, the weight for a specified value of 1 is determined by parameter switching. In increment system B, the weight for a specified value of 1 is 1 μ . This servo amplifier module does not perform parameter switching, but requires the user to determine the weight for a specified value of 1.
- 2 Do not change the value of a parameter not included in the parameter list because that parameter may be used for an internal variable. For example, parameter No. 029 is used for an internal variable. Even if this parameter has a nonzero value, ignore the parameter without changing the value.

B.1 CONTROLLED-AXIS PARAMETERS

No	#7	#6	#5	#4	#3	#2	#1	#0
000	ROAX	RABX				RAB2X	ROTX	

[Size] 1 byte (bit type)
 [Standard value] 0

ROTX Specifies whether the controlled axis is a linear or rotation axis, as follows:
 0 : Linear axis
 1 : Rotation axis

NOTE

For velocity control, set a rotation axis.

RAB2X Specifies whether the specification of the sign of the absolute command-based rotation direction of the rotation axis is valid, as follows:
 0 : Invalid
 1 : Valid

NOTE

For details, see Section 3.6.2, "Rotation axis rotation direction sign specification function."

RABX Specifies the absolute command-based rotation direction of the rotation axis for movement within one revolution, as follows:
 1 : Direction of the smallest distance to a desired point
 0 : Direction determined according to a command-specified sign

NOTE

This parameter is valid only when ROAX = 1.

ROAX Specifies whether the roll-over function of the rotation axis is valid, as follows:
 0 : Invalid
 1 : Valid

NOTE

For velocity control, enable the roll-over function of the rotation axis.

B.2 COORDINATE SYSTEM AND STROKE LIMIT PARAMETERS

No	#7	#6	#5	#4	#3	#2	#1	#0
001	EPEXB	EPEXA		N405	SSL1	HOT	ZRTN	

[Size] 1 byte (bit type)
 [Standard value] 0

ZRTN Specifies whether an alarm is to be issued if a reference position is not set up, as follows:
 0 : An alarm is issued.
 1 : An alarm is not issued.

HOT Specifies whether the overtravel direct input signals (*+OT and *-OT) are valid, as follows:
 0 : Invalid
 1 : Valid

SSL1 Specifies whether stored stroke limit 1 is valid, as follows:
 0 : Invalid
 1 : Valid

NOTE

This parameter is invalid until reference position return is completed.

- N405 Specifies whether a servo alarm is to be issued if reference position cannot be executed correctly, as follows:
 0 : A servo alarm is issued. (No. 405)
 1 : A servo alarm is not issued.

NOTE

If a value in the range of 4 to 96 is set for parameter No. 032 (CMR), servo alarm No. 405 may be issued during reference position return. In this case, prevent the alarm from being issued by setting N405 to "1".

EPEXA, EPEXB Specify the operation that is to occur if the axis movement rate determined according to external pulses exceeds the feedrate upper limit specified in parameter No. 043.

EPEXB	EPEXA	Description
0	0	The feedrate is clamped to the parameter-specified value, and the excessive pulses are treated as accumulated pulses. If the number of accumulated pulses exceeds 99999999, the excessive pulses are discarded.
0	1	Alarm 291 is issued, leading to deceleration and stop.
1	0	The feedrate is clamped to the parameter-specified value, and the excessive pulses are discarded.
1	1	Alarm 291 is issued, leading to deceleration and stop.

No

068	Number of magazines/turrets
------------	------------------------------------

 [Size] 2-byte
 [Valid data range] 1 to 9999
 [Standard value] 0
 [Description] Sets up the number of magazines/turrets.

No

140	Machine coordinate of the reference position
------------	---

 [Size] 4-byte
 [Unit of data] User-specified unit
 [Valid data range] 0 to ±99999999
 [Standard value] 0
 [Description] Sets up the machine coordinate for the reference position.
 When setting of the reference position, either without dogs or externally, is completed, the machine coordinate is preset to the value specified in the parameter.

No

141	Amount of movement per rotation axis revolution
------------	--

 [Size] 4-byte
 [Unit of data] User-specified unit
 [Valid data range] 0 to 99999999
 [Standard value] 0
 [Description] Specifies an amount of movement per revolution for the rotation axis. If 0 is specified, the amount of movement is assumed to be 36000.

⚠ CAUTION

The amount of motor revolution corresponding to the amount of movement per rotation axis revolution must be 2500 revolutions or less. If the amount of motor revolution corresponding to the amount of movement per rotation axis revolution exceeds 2500 revolutions, reduce the amount of motor revolution to 2500 or below, by reducing the gear reduction ratio or by other means.

	No	
	142	Positive machine coordinate for stored stroke limit 1
	No	
	143	Negative machine coordinate for stored stroke limit 1
[Size]	4-byte	
[Unit of data]	User-specified unit	
[Valid data range]	0 to ± 99999999	
[Standard value]	99999999 (positive machine coordinate), -99999999 (negative machine coordinate)	
[Description]	Sets up the positive and negative machine coordinates for stored stroke limit 1. Areas outside the specified ranges are forbidden areas.	
	No	
	144	Machine coordinate for the second reference position
	No	
	145	Machine coordinate for the third reference position
[Size]	4-byte	
[Unit of data]	User-specified unit	
[Valid data range]	0 to ± 99999999	
[Standard value]	0	
[Description]	Sets up the machine coordinates for the second and third reference positions.	
	No	
	147	Workpiece coordinate for the reference position
[Size]	4-byte	
[Unit of data]	User-specified unit	
[Valid data range]	0 to ± 99999999	
[Standard value]	0	
[Description]	Sets up the workpiece coordinate for the reference position. When setting the reference position, either without dogs or externally, is completed, the workpiece coordinate of the reference position is preset to the value specified in the parameter. This parameter is fixed to 0 for the rotation axis.	

No	
154	Position for point number 1
⋮	⋮
165	Position for point number 12

[Size] 4-byte
 [Unit of data] User-specified unit
 [Valid data range] 0 to ±99999999
 [Standard value] 0
 [Description] Specify positions for point numbers 1 to 12 for point positioning.

No	
170	Index point tolerance

[Size] 4-byte
 [Unit of data] User-specified unit
 [Valid data range] 0 to 99999999
 [Standard value] 0
 [Description] When the 1-pitch rotation of ATC/turret control is specified, the index point is preserved if the machine deviates from the index point during clamping/ unclamping, as long as the absolute value for the movement amount is equal to or less than this value. For example, when the machine is to move from index point 1 to 2, it can move to the position of point 2 even if it has deviated from the position of point 1 in the direction opposite from the direction of movement, as long as the movement amount is within the value specified in this parameter. In ATC/turret control, this parameter is also used to specify a tolerable magazine range when a turret/magazine number is always output to response data.

NOTE
 When bit 5 of parameter No.007 is 1 (a turret/magazine number is always output to response data), set a tolerable magazine range in this parameter.

B.3 FEEDRATE PARAMETERS

	No	
	021	Feedrate command weight N
[Size]	1 byte	
[Unit of data]		
[Valid data range]	0 to 8	
[Standard value]	3	
[Description]	Sets up a weight for feedrate parameter Nos. 040, 041, 043 to 050, 054, 059 to 061. Supposing 3 is specified, the feedrate is assumed to be a parameter-specified feedrate multiplied by 10^3 (= 1000).	
	No	
	040	Rapid traverse rate
[Size]	2-byte	
[Unit of data]	10^N User-specified unit/MIN	
[Valid data range]	1 to 65535 (7500 user-specified units/MIN or greater)	
[Standard value]	4000	
[Description]	Specifies a rapid traverse rate. (N is specified in parameter No. 021.)	
	No	
	041	Jog feedrate
[Size]	2-byte	
[Unit of data]	10^N User-specified unit/MIN	
[Valid data range]	1 to 65535 (4 user-specified units/MIN or greater)	
[Standard value]	2000	
[Description]	Specifies the feedrate for job feed when the feedrate override value is 100%. (N is specified in parameter No. 021.)	
	No	
	043	Feedrate upper limit
[Size]	2-byte	
[Unit of data]	10^N User-specified unit/MIN	
[Valid data range]	1 to 65535	
[Standard value]	4000	
[Description]	Specifies the upper limit for the feedrate to be specified. If an attempt is made to specify a value larger than the upper limit, the actual feedrate is clamped to the upper limit. (N is specified in parameter No. 021.)	

No	
044	Feedrate specified for feedrate code 1
045	Feedrate specified for feedrate code 2
046	Feedrate specified for feedrate code 3
047	Feedrate specified for feedrate code 4
048	Feedrate specified for feedrate code 5
049	Feedrate specified for feedrate code 6
050	Feedrate specified for feedrate code 7
[Size]	2-byte
[Unit of data]	10 ^N User-specified unit/MIN
[Valid data range]	1 to 65535 (4 user-specified units/MIN or greater)
[Standard value]	2000
[Description]	Specify the feedrates corresponding to feedrate codes 1 to 7 for command data 1 for a function code command. (N is specified in parameter No. 021.)
No	
054	FL rate for a reference position return
[Size]	2-byte
[Unit of data]	10 ^N User-specified unit/MIN
[Valid data range]	1 to 65535 (7500 user-specified units/MIN or greater)
[Standard value]	100
[Description]	Specifies a rate of movement to the next grid point during setting of the reference position. (N is specified in parameter No. 021.)
No	
061	F0 rate for rapid traverse override
[Size]	2-byte
[Unit of data]	10 ^N User-specified unit/MIN
[Valid data range]	1 to 65535 (7500 user-specified units/MIN or greater)
[Standard value]	10
[Description]	Specifies the F0 rate for rapid traverse override. (N is specified in parameter No. 021.)

	No	
	066	F1 rate for rapid traverse override
[Size]	2-byte	
[Unit of data]	10 ^N User-specified unit/MIN	
[Valid data range]	1 to 65535 (7500 user-specified units/MIN or greater)	
[Standard value]	10	
[Description]	Specifies the F1 rate for rapid traverse override. (N is specified in parameter No. 021.)	

NOTE

This parameter is valid when bit 6 (RVF2) of parameter No. 002 is 1.

	No	
	067	F2 rate for rapid traverse override
[Size]	2-byte	
[Unit of data]	10 ^N User-specified unit/MIN	
[Valid data range]	1 to 65535 (7500 user-specified units/MIN or greater)	
[Standard value]	10	
[Description]	Specifies the F2 rate for rapid traverse override. (N is specified in parameter No. 021.)	

NOTE

This parameter is valid when bit 6 (RVF2) of parameter No. 002 is 1.

B.4 ACCELERATION/DECELERATION CONTROL PARAMETERS

No	#7	#6	#5	#4	#3	#2	#1	#0
002	CSMZ	RVF2			CIPC		JOGE	RPDE

[Size] 1 byte (bit type)
 [Standard value] 0

NOTE
 In the explanation below, cutting feed means a feed type that is neither rapid traverse nor jog feed.

RPDE Specifies the acceleration/deceleration type for rapid traverse, as follows:
 0 : Linear or bell-shaped acceleration/deceleration

NOTE
 Bell-shaped acceleration/deceleration is selected if rapid traverse bell-shaped acceleration/deceleration time constant T2 is specified.

1 : Exponential acceleration/deceleration

JOGE Specifies the acceleration/deceleration type for jog or cutting feed, as follows:
 0 : Linear or bell-shaped acceleration/deceleration

NOTE
 Bell-shaped acceleration/deceleration is selected if jog or cutting feed rapid traverse bell-shaped acceleration/deceleration time constant T2 is specified.

1 : Exponential acceleration/deceleration

CIPC Specifies whether to enable switching between effective areas for in-position check, regardless of whether a direct command specifies rapid traverse or cutting feed for the next block, as follows:
 0 : Disabled.
 1 : Enabled.

RVF2 For a rapid traverse override, a feedrate is specified in 4 steps of:
 0 : 100%, 50%, 25%, F0.
 1 : 100%, F1, F2, F0.
 The table below lists override values determined by the rapid traverse override signals ROV1 and ROV2.

ROV2	ROV1	Override value	
		RVF2=0	RVF2=1
0	0	100%	100%
0	1	50%	F1
1	0	25%	F2
1	1	F0	F0

NOTE

For F0, F1, and F2, set actual feedrates in parameters No. 061, No. 066, and No. 067, respectively.

CSMZ Specifies whether to enable the output signal SMZX (Yy+7#5) of a direct command, as follows:

0 : Disabled.

1 : Enabled.

No**055**

Rapid traverse linear acceleration/deceleration time constant or rapid traverse bell-shaped acceleration/deceleration time constant T1
Rapid traverse exponential acceleration/deceleration time constant

[Size] 2-byte
 [Unit of data] msec
 [Valid data range] 0 to 4000
 [Standard value] 100
 [Description]

Specifies a rapid traverse acceleration/deceleration time constant. The acceleration/deceleration time constant to be used is determined depending on whether bit 0 of parameter No. 002 (RPDE) and rapid traverse bell-shaped acceleration/deceleration time constant T2 are set.

No**056**

Rapid traverse bell-shaped acceleration/deceleration time constant T2
--

[Size] 2-byte
 [Unit of data] msec
 [Valid data range] 0 to 512
 [Standard value] 100
 [Description]

Specifies rapid traverse bell-shaped acceleration/deceleration time constant T2.

		No	
	057		Linear acceleration/deceleration time constant or bell-shaped acceleration/deceleration time constant T1 for jog feed or feed based on feedrate codes 1 to 7
			Exponential acceleration/deceleration time constant for jog feed or feed based on feedrate codes 1 to 7
[Size]		2-byte	
[Unit of data]		msec	
[Valid data range]		0 to 4000	
[Standard value]		100	
[Description]		Specifies an acceleration/deceleration time constant for jog feed or feed based on feedrate codes 1 to 7. The acceleration/deceleration time constant to be used is determined depending on whether bit 1 of parameter No. 002 (JOGE) and bell-shaped acceleration/deceleration time constant T2 for jog feed or feed based on feedrate codes 1 to 7 are set.	
		No	
	058		Bell-shaped acceleration/deceleration time constant T2 for jog feed or feed based on feedrate codes 1 to 7
[Size]		2-byte	
[Unit of data]		msec	
[Valid data range]		0 to 512	
[Standard value]		100	
[Description]		Specifies bell-shaped acceleration/deceleration time constant T2 for jog feed or feed based on feedrate codes 1 to 7.	
		No	
	059		Exponential acceleration/deceleration FL rate for jog feed or feed based on feedrate codes 1 to 7
[Size]		2-byte	
[Unit of data]		10^N User-specified unit/MIN	
[Valid data range]		1 to 65535 (7500 user-specified units/MIN or greater)	
[Standard value]		10	
[Description]		Specifies the exponential acceleration/deceleration time constant FL rate for jog feed or feed based on feedrate codes 1 to 7. (N is specified in parameter No. 021.)	
		No	
	060		FL rate for rapid traverse exponential acceleration/deceleration
[Size]		2-byte	
[Unit of data]		10^N User-specified unit/MIN	
[Valid data range]		1 to 65535 (7500 user-specified units/MIN or greater)	
[Standard value]		10	
[Description]		Specifies the FL rate for rapid traverse exponential acceleration/deceleration. (N is specified in parameter No. 021.)	

B.5 INPUT/OUTPUT SIGNALS PARAMETERS

No	#7	#6	#5	#4	#3	#2	#1	#0
003	STON	EXPLS	WAT2			IGCP	NCLP	
[Size]	1 byte (bit type)							
[Standard value]	1 only for NCLP							
NCLP	Specifies whether to use clamping/unclamping, as follows: 0 : Clamping/unclamping is used. 1 : Clamping/unclamping is not used.							
IGCP	Specifies whether to check a clamp/unclamp state (UCPS2) before proceeding to the next sequence, as follows: 0 : A clamp/unclamp state is checked. 1 : A clamp/unclamp state is not checked.							
WAT2	Indicates whether an ID code can be specified for a wait function, as follows: 0 : An ID code cannot be specified. 1 : An ID code can be specified.							
EXPLS	Indicates whether an axis movement function based on external pulses (pulses from a manual pulse generator) is valid, as follows: 0 : Invalid. 1 : Valid.							
STON	Specifies whether an automatic operation is started at the rising (off to on) or falling (on to off) edge of the automatic operation start (ST) signal, as follows: 0 : Falling edge (on to off) 1 : Rising edge (off to on)							
No	#7	#6	#5	#4	#3	#2	#1	#0
004					NEPRM	ZRNO		
[Size]	1 byte (bit type)							
[Standard value]	0							
ZRNO	Specifies whether to enable input of a reference position establishment signal, as follows: 0 : Disabled. 1 : Enabled.							
NEPRM	Specifies whether to perform writing to the EEPROM (memory for storing parameter settings) when rewriting parameters using peripheral device control or a direct command, as follows: 0 : Writing is performed. 1 : Writing is not performed.							

⚠ CAUTION

- 1 There is a limit to the number of writes to the EEPROM (memory for storing parameter settings) (tens of thousands of writes). For this reason, set NEPR to 1 if parameters are to be rewritten frequently using peripheral device control or a direct command.
- 2 Those parameters that were rewritten to values different from their initial values when NEPRM was "1" must not be rewritten when NEPRM is "0." Otherwise, an EEPROM parity mismatch occurs, with the result that a parity error occurs and standard settings are loaded when the power is turned OFF and then ON again.

If parameters are rewritten from the MDI using the power mate CNC manager (PMM), writing to the EEPROM is performed regardless of the value of NEPRM. Consequently, a parity error also occurs if those parameters that were rewritten using the ladder when NEPRM was "1" are rewritten from the MDI.

(Example)

A parity error occurs and standard settings are loaded if the following is performed:

"3" is set for parameter No. 020 at power on.

↓

a) Set "1" for parameter No. 020 using the ladder when NEPRM is "1."

↓

b) Set "2" for parameter No. 020 using the ladder when NEPRM is "0."

Alternatively,

c) Set "2" for parameter No. 020 from the MDI using the PMM.

↓

Turn the power OFF and then ON again.

↓

Standard settings are loaded.

* If b) or c) is not performed, a parity error is not issued.

No	#7	#6	#5	#4	#3	#2	#1	#0
005	ABSPS	LDM	MP	IOH		REFDRC	CLPSVF	JNCL

[Size] 1 byte (bit type)
[Standard value] 0

JNCL Specifies whether to use clamping when JOG operation stops, as follows:
0 : Clamping is performed.
1 : Clamping is not performed. (The unclamp state is preserved.)

CLPSVF The time from clamping to servo off (parameter No. 168) is:
0 : Time from the point the unclamping instruction signal (UCPC2) turns off
1 : Time from the point the clamping/unclamp state output signal (UCPS2) turns off.

REFDRC The direction of the high-speed origin return of the rotation axis depends on:
0 : Sign of the result of subtracting the current position from the reference position.
1 : Setting of ZMIX (bit 5 of parameter No. 010).

IOH Specifies whether to enable manual handle feed over the I/O Link, as follows:
0 : Disabled.
1 : Enabled.

NOTE
When this parameter is set to 1, bit 6 (EXPLS) of parameter No. 003 must be set to 0.

MP Specifies whether to enable setting of a magnification in 4 steps with the MP1/MP2 signal for input manual handle pulses for manual handle feed, as follows:
0 : Disabled.
1 : Enabled.

LDM Specifies whether the output of the motor current value is valid to the response data (Xx+3 to Xx+6), as follows:
0 : Invalid.
1 : Valid.

ABSPS Specifies whether the host and a servo amplifier module are to be synchronized with each other in the response data read function, as follows:
0 : Not synchronized.
1 : Synchronized. (This makes it possible for the host to read the correct position even during axis movement.)

NOTE

- 1 For details, see Part II, Section 3.8, "Upgrading the Response Data Read Function."
- 2 When bit 5 of parameter No.007 is 1 (a turret/magazine number is always output to response data), set this parameter to 1.

No	#7	#6	#5	#4	#3	#2	#1	#0
007			ATCR2	VCTLB		NZRPO	PSSV	ABSV

[Size] 1 byte (bit type)
 [Standard value] 0

ABSV Specifies whether to make allowance for delays including an acceleration/deceleration delay and servo delay when coordinates are read from the host to the servo amplifier module, as follows:
 0 : Positions where allowance for delays is not made are read.
 1 : Positions where allowance for delays is made (actual motor positions) are read.

NOTE

- 1 This parameter is valid when coordinates are read as described below.
 - (1) Machine coordinates or workpiece coordinates are output to response data for peripheral equipment control.
 - (2) A direct command is used to specify any of the following:
 - Reading of absolute positions (function code 0x30)
 - Reading of machine positions (function code 0x31)
 - Reading of absolute positions or machine positions using a continuous data read command (function code 0x41)
- 2 Due to a delay, for example, in data exchange over the FANUC I/O Link, coordinate positions that are read have a maximum delay of 30 to 40 msec.

PSSV Specifies whether to make allowance for delays including an acceleration/deceleration delay and servo delay when area signals are input, as follows:
 0 : Area signals are input at positions where allowance for delays is not made.
 1 : Area signals are input at positions where allowance for delays is made (actual motor positions).

NZRPO Specifies whether to output a turret/magazine number or point number when ATC/turret control or point positioning control is performed, if a reference position is not established, as follows:

0 : Not output.

1 : Output.

 **CAUTION**

When an incremental pulse coder is used with bit 2 (NZRPO) of parameter No. 007 set to 1, be sure to set a coordinate system to establish a relationship between the machine and absolute coordinates, before performing ATC operation or point positioning. If ATC operation or point positioning is performed before a coordinate system is set, positioning to correct machine positions may not occur. A turret/magazine number or point number that is then output may not be correct. This affects all types of positioning, not only ATC operation and point positioning.

NOTE

- 1 This parameter is valid when parameter No. 020 is set to 1.
- 2 This parameter is also valid when bit 5 of parameter No. 007 is 1 (a turret/magazine number is always output to response data).

VCTLB Specifies the velocity control type for peripheral equipment control, as follows:

0 : Type A (the torque limit value cannot be specified).

1 : Type B (the torque limit value can be specified).

ATCR2 Specifies when to output a turret/magazine number, as follows:

0 : A turret/magazine number is output when ATC/turret control is performed. (Conventional method)

1 : A turret/magazine number is always output. (New method)

 **CAUTION**

In the new method, even if a function code for other than ATC/turret control (function code 2) is specified, the turret/magazine number and MINP, +MOR, and -MOR signals corresponding to the current position are always output to response data. Note that, for example, if point positioning is performed, a point number and the MINP, +MOR, and -MOR signals corresponding to the point number are not output to response data.

NOTE

- 1 To enable the new method, the following conditions must also be satisfied.
 - Set parameters as described below to enable ATC/turret control (function code 2).
Select a rotation axis (bit 1 of parameter No.000 is 1).
Enable the roll-over function (bit 7 of parameter No.000 is 1).
Set the number of magazines/turrets (parameter No. 068).
Set an index point tolerance (parameter No. 170).
 - Set parameter No.020 to 1 (an ATC and point number are output to response data).
 - Set bit 7 of parameter No.005 to 1 (the host and a servo amplifier module are synchronized with each other in the response data read function).
- 2 In the new method, response data must be read in a synchronous manner. The response data retained is thus based on a position when the logic of ABSWT (XX+1#0) is reversed, and the data is not updated until the next time the ABSWT logic is reversed.

	No	Response data specification (PHOUT)
	020	
[Size]	1 byte	
[Standard value]	3	
PHOUT	<p>Specifies whether or what to output as response data (Xx+3 to Xx+6), as follows:</p> <p>0 : Nothing is output.</p> <p>1 : An ATC and point No. are output if an ATC cycle and point positioning are involved.</p> <p>2 : Machine coordinates are output in real time.</p> <p>3 : Workpiece coordinates are output in real time.</p> <p>4 : The motor current value is output. The motor current value is 6554, which is the maximum current value for the amplifier.</p> <p>5 : Measurement data (workpiece coordinates) obtained when a skip signal is input is output.</p> <p>6 : An actual feedrate is output in real time. [Unit of data] 10^NUser-specified unit/MIN (N:Parameter No. 021)</p> <p>7 : An actual speed is output in real time. [Unit of data] min⁻¹</p> <p>8 : A torque command is output in real time. The maximum value of a torque command is 6554. The least significant bit is a signal indicating whether the torque limit is reached. Least significant bit = 0: The torque limit is not reached. 1: The torque limit is reached.</p>	

NOTE

- 1 An ATC and point number are not output until a reference position is established. When bit 2 (NZRPO) of parameter No. 007 is set to 1, however, an ATC and point number are output even if a reference position is not established.
- 2 If the motor current value is output as response data, set LDM (bit 6 of parameter No. 005) to "1" and set "4" for parameter No. 020.
- 3 When bit 5 of parameter No. 007 is 1 (a turret/magazine number is always output to response data), set this parameter to 1.
- 4 The value of an actual speed is output with a sign. While the motor is being stopped, the motor current may drift, causing the sign to be unstable.

No
022 ECF and EBSY signal minimum output time
 [Size] 1 byte
 [Unit of data] 8msec
 [Valid data range] 0 to 127
 [Standard value] 5
 [Description] Specifies the minimum output time for the ECF and EBSY signals (direct command interface control flag 2). This is valid when the power mate CNC manager is used.

No
023 PMM allocation rate assumed when reading continuous data with a direct command
 [Size] 1 byte
 [Valid data range] 0 to 100
 [Standard value] 50
 Do not change the parameter from its standard value.

No
024 Axis name (1st character)

No
025 Axis name (2nd character)
 [Size] 1 byte
 [Valid data range] 0, 32 (“ ” space)
 48 (“0”) to 57 (“9”)
 65 (“A”) to 90 (“Z”)

 [Description] Set an axis name using two characters (parameters No. 024 and No. 025).
 If a setting is out of range, “ ” (space) is displayed.
 When parameter No. 024 is set to 0, an axis name is 1, regardless of the setting of parameter No. 025.

Setting	Displayed character
0	Space
32	Space
48	0
49	1
50	2
51	3
52	4
53	5
54	6
55	7

Setting	Displayed character
56	8
57	9
65	A
66	B
67	C
68	D
69	E
70	F
71	G
72	H

Setting	Displayed character
73	I
74	J
75	K
76	L
77	M
78	N
79	O
80	P
81	Q
82	R

Setting	Displayed character
83	S
84	T
85	U
86	V
87	W
88	X
89	Y
90	Z

Example)

To set **X3** as an axis name:

Set parameter No. 024 to 88 and parameter No. 025 to 51.

	No	
	029	Internal variable
[Size]	1 byte	
	Do not change the value of the parameter.	
	<p>NOTE</p> <p>1 Even if this parameter has a nonzero value, ignore the parameter without changing the value.</p> <p>2 There is no problem even if this parameter is rewritten when all parameters are written at once.</p>	
	No	
	062	External pulse input-based axis movement amount ratio setting 1 (M)
	063	External pulse input-based axis movement amount ratio setting 2 (N)
[Size]	2-byte	
[Valid data range]	1 to 32767	
[Standard value]	1	
[Description]	Specify a ratio M/N for an axis movement amount based on an external pulse input.	
	No	
	148	Servo positional deviation monitor amount
[Size]	4-byte	
[Unit of data]	Detection unit	
[Valid data range]	0 to 99999999	
[Standard value]	99999999	
[Description]	Specifies the servo positional deviation monitor amount. The SVERX signal becomes 1 when the servo positional deviation amount becomes larger than the value specified in this parameter.	
	No	
	149	Remaining travel limit for outputting the remaining travel in-range signal (DEN2)
[Size]	4-byte	
[Unit of data]	User-specified unit	
[Valid data range]	0 to 99999999	
[Standard value]	0	
[Description]	Specifies the absolute value of a remaining travel value used as a limit to output the remaining travel in-range signal (DEN2).	

No	
150	Coordinates (minimum) for point 1 in the operation range of the area signals
151	Coordinates for point 2 in the operation range of the area signals
152	Coordinates for point 3 in the operation range of the area signals

[Size] 4-byte
 [Unit of data] User-specified unit
 [Valid data range] 0 to ±99999999
 [Standard value] 0
 [Description] Specify the points for the output range of the area signals using machine coordinates. Area signals PSG1 and PSG2 are output according to the result of comparison between the machine coordinate and a parameter-specified value. The output conditions are listed below. ABSMT represents the current machine coordinate.

Condition	PSG2	PSG1
ABSMT < point 1	0	0
Point 1 ≤ ABSMT < point 2	0	1
Point 2 ≤ ABSMT < point 3	1	0
Point 3 ≤ ABSMT	1	1

NOTE
 When bit 1 (PSSV) of parameter No. 007 is 1, area signals can be input at actual motor position where allowance for delays including an acceleration/deceleration delay and motor delay is made.

No	
166	Operation completion signal output time

[Size] 4-byte
 [Unit of data] 8msec
 [Valid data range] 0 to 99999999
 [Standard value] 5
 [Description] Specifies the output time for operation completion signals OPC1 to OPC4.

NOTE
 If 0 is set, no operation completion signal is not output.

		No	
		167	Time between servo-on and unclamping
[Size]		4-byte	
[Unit of data]		8msec	
[Valid data range]		0 to 99999999	
[Standard value]		0	
[Description]		Specifies a time interval from the time the servo system is switched on until the machine is unclamped if clamping/unclamping is used.	
		No	
		168	Time between clamping and servo-off
[Size]		4-byte	
[Unit of data]		8msec	
[Valid data range]		0 to 99999999	
[Standard value]		0	
[Description]		Specifies a time interval from the time the machine is clamped until the servo system is switched off if clamping/unclamping is used.	
		No	
		169	Time allowed before the next sequence is executed without clamping/unclamping
[Size]		4-byte	
[Unit of data]		8msec	
[Valid data range]		0 to 99999999	
[Standard value]		0	
[Description]		Specifies a time interval from the time the clamp/unclamp command (UCPC2) is issued until the next sequence is started, if the clamp/unclamp state signal (UCPS2) is not to be checked. Whether to check the clamp/unclamp state signal (UCPS2) is specified using bit 2 of parameter No. 003 (IGCP).	

B.6 SERVO PARAMETERS

No	#7	#6	#5	#4	#3	#2	#1	#0
010	SVFP	ECMR	ZMIX			IEBL	IALM	IINP

[Size] 1 byte (bit type)
 [Standard value] 1 for SVFP only

- IINP Specifies whether to make in-position check when the torque is limited, as follows:
 0 : In-position check is not made.
 1 : In-position check is made.

NOTE

This parameter is valid, when parameter No.0108 is not 0 and IEBL = 1.

- IALM Specifies whether to check for a stop- and movement-time excessive error when the torque is limited, as follows:
 0 : An error check is not made.
 1 : An error check is made.

NOTE

This parameter is valid, when parameter No.0108 is not 0 and IEBL = 1.

- IEBL Specifies whether to enable the torque limit function, as follows:
 0 : Disable
 1 : Enable
- ZMIX Specifies the initial direction of backlash and grid movement in a reference position return without dogs, as follows:
 0 : Positive direction
 1 : Negative direction
- ECMR Specifies whether to enable expansion of the setting range for the command multiplier, as follows:
 0 : Disabled. (The setting of parameter No. 032 is valid for the command multiplier.)
 1 : Enabled. (The setting of parameter No. 138 is valid for the command multiplier.)
- SVFP Specifies whether to perform follow-up, as follows:
 0 : Follow-up is not performed.
 1 : Follow-up is performed.

No	#7	#6	#5	#4	#3	#2	#1	#0
011	APCX	MVZPFR				DZRN	SZRN	ABSX

[Size] 1 byte (bit type)
 [Standard value] 1 only for APCX

ABSX Indicates whether the absolute position detector has been associated with the machine position, as follows:
 0 : Has not been associated
 1 : Has been associated

SZRN Specifies the type of positioning to a grid to be performed for a manual reference position return if the feed axis and direction selection signal (+X, -X, or I/O link signal from the host) is 1 for reference position return without dogs, as follows:
 0 : Positioning to a grid is performed only once.
 1 : Positioning to a grid is performed each time the feed axis and direction selection signal becomes 1.

DZRN Specifies whether the reference position return function with dogs is valid, as follows:
 0 : Invalid. (The reference position return function without dogs is selected.)
 1 : Valid

⚠ CAUTION

When DZRN = 1, the high-speed interlock signal (*RILK) is invalid.

MVZPFR On a rotation axis where the absolute-position detector is used, when the reference position is updated and the value of the amount of movement has a fractional part:
 0 : The reference position is updated, making allowance for the fractional part.
 1 : The reference position is updated, without making allowance for the fractional part.

NOTE

Set this parameter to 1 only when a rotation axis uses the absolute-position detector, and a positional error may occur, as described in the notes on parameter No. 032. Otherwise, this parameter must be set to 0.

LIMITATIONS

When this parameter is used, the limits below are imposed on the settings of the amount of movement per rotation axis revolution (parameter No. 141), command multiplier (CMR) (parameter No. 032), and denominator for the number of pulses per motor revolution (SDMR2) (parameter No. 106). If any of the limits is exceeded, this parameter cannot be used.

Amount of movement per rotation axis revolution (parameter No. 141) × K
 × Denominator for the number of pulses per motor revolution (parameter No. 106) ≤ 247 - 1
 where

$$K = \frac{\text{User-specified unit}}{\text{Detection unit}}$$

- When $K \geq 1$, $CMR = 2 \times K$ ($1 \leq K \leq 48$).
 (When expanded CMR (parameter No. 138) is used, however, $1 \leq K \leq 200$.)
- When $K < 1$, $CMR = 1/K + 100$ ($1/2 \leq K \leq 1/27$).
 If $K \geq 1$, the above conditional expression applies.
 If $K < 1$, the conditional expression does not require the K term, and is set as follows.
 Amount of movement per rotation axis revolution (parameter No. 141)
 × Denominator for the number of pulses per motor revolution (parameter No.106) ≤ 247 - 1

APCX Indicates whether a detector for an absolute pulse coder is available.
 0 : Unavailable
 1 : Available

No	#7	#6	#5	#4	#3	#2	#1	#0
012							DGPR	

[Size] 1 byte (bit type)
 [Standard value] 0

DGPR Specifies whether to set motor-specific servo parameters when the power is switched on.
 0 : Set.
 1 : Do not set.

After a motor type (parameter No. 30) is specified, resetting this bit to 0 automatically sets up the standard values for the motor when the power is turned on. At the same time, the bit is set to 1 again.

No	#7	#6	#5	#4	#3	#2	#1	#0
013			TSA2	TSA1			VCM2	VCM1

[Size] 1 byte (bit type)
 [Standard value] 0

When bits 0 and 1 of parameter No. 14 are 0 and 0, the following signals are output to the servo check board.

- DATA0 VCMD (velocity command)
- DATA1 TCMD (torque command)
- DATA2 TSA (actual speed)

These parameters determine the scale of data on DATA0 and DATA2, as listed below:

VCM2	VCM1	DATA0
0	0	For VCMD, 5 V corresponds to 3750 min ⁻¹ .
0	1	For VCMD, 5 V corresponds to 234 min ⁻¹ .
1	0	For VCMD, 5 V corresponds to 14.6 min ⁻¹ .
1	1	For VCMD, 5 V corresponds to 0.92 min ⁻¹ .

TSA2	TSA1	DATA2
0	0	For TSA, 5 V corresponds to 3750 min ⁻¹ .
0	1	For TSA, 5 V corresponds to 234 min ⁻¹ .
1	0	For TSA, 5 V corresponds to 14.6 min ⁻¹ .
1	1	For TSA, 5 V corresponds to 0.92 min ⁻¹ .

No	#7	#6	#5	#4	#3	#2	#1	#0
014							TDOU	IRS

[Size] 1 byte (bit type)
 [Standard value] 0

IRS Setting this bit to 1 causes the following current to flow in check board DATA0 and DATA1.
 Bit 1 of parameter No. 014 must be set to 0.

- DATA0 R-phase actual current (4 V corresponds the maximum current.)
- DATA1 S-phase actual current (4 V corresponds the maximum current.)

TDOU Setting this bit to 1 causes a specified acceleration and an estimated load torque to be output to DATA0 and DATA1 of the check board.
 Bit 0 of parameter No. 014 must be set to 0.

- DATA0 Specified acceleration
- DATA1 Estimated load torque

No	#7	#6	#5	#4	#3	#2	#1	#0
016			FFAL	FFVL			LVMD	PIIP

[Size] 1 byte (bit type)
 [Standard value] 0

PIIP 0 : Specifies that the velocity loop be subject to PI control.
 1 : Specifies that the velocity loop be subject to IP control.

LVMD 0 : Disables the low-velocity integration function.
 1 : Enables the low-velocity integration function.

FFVL, FFAL Specify whether to enable the feed-forward function.
 The feed-forward function is enabled only when FFVL and FFAL are 1.

FFVL	FFAL	Description
1	1	The feed-forward function is enabled.
0	*	The feed-forward function is disabled regardless of whether FFAL is 1.
1	0	The feed-forward function is disabled.

No	#7	#6	#5	#4	#3	#2	#1	#0
017						SPCO	HEDG	HENB

[Size] 1 byte (bit type)
 [Standard value] 0

HENB Specifies whether to use the skip function.
 0 : The skip function is not used.
 1 : The skip function is used.

HEDG When a skip signal is used with the skip function:
 0 : The skip signal is handled as an input signal on the rising edge (0 → 1).
 1 : The skip signal is handled as an input signal on the falling edge(1 → 0).

SPCO During execution of the skip function, if a skip signal (HDI) is not input and the end point is reached:
 0 : The data on the last skip measurement is retained.
 1 : Specified coordinates of the end point are recorded as skip measurement data.

No	
030	Set 0. Set the motor type number in parameter No. 125.

Set parameter No. 030 to 0, and set the motor type number in parameter No. 125.

		No	
		031	Direction of motor rotation (DIRCTL)
	[Size]	1 byte	
	[Standard value]	111	
		The direction of motor rotation is specified, as follows:	
		111: Normal connection (clockwise rotation as viewed from the detector side)	
		-111: Reverse connection (counterclockwise rotation as viewed from the detector side)	

		No	
		032	Command multiplier (CMR)
	[Size]	1 byte	
	[Valid data range]	2 to 96, 102 to 127	

NOTE

Only even numbers in the range of 2 to 96 can be set.

[Standard value] 2

This parameter is used to set up a ratio of the user-specified unit to the detection unit.

Let K be the user-specified unit divided by the detection unit, then enter:

$$\text{CMR} = 2 \times K \text{ if } K \geq 1$$

$$\text{CMR} = 1/K + 100 \text{ if } K < 1$$

where K is a value from 1 to 48 or from 1/2 to 1/27.

Example 1)

If the least command increment is 10 μm , and the detection increment is 5 μm :

$$\text{CMR} = 10/5 \times 2 = 4$$

Example 2)

If the least command increment is 10 μm , and the detection increment is 20 μm :

$$\text{CMR} = 1/(1/2) + 100 = 102$$

because $K = 10/20 < 1$

⚠ CAUTION

On an axis where the absolute-position detector is used, the reference position is stored using the coordinates of the absolute-position detector. On a rotation axis, to preserve the positional relationship between the coordinates of the absolute-position detector and the reference position, the coordinates of the absolute-position detector that correspond to the reference position must be shifted each time movement is performed by the amount of movement per rotation axis revolution specified for position parameter No. 141. (See the figure below.)

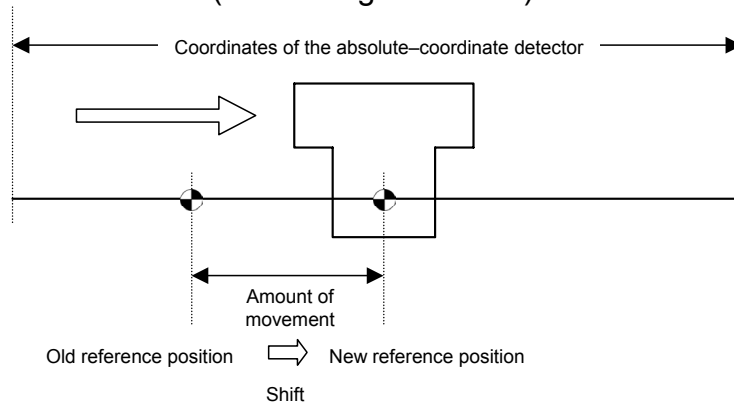

Because the reference position is stored using the coordinates of the absolute-position detector, the reference position is shifted in the absolute-position detector pulse units corresponding to one revolution.

The formula for converting the amount of movement per rotation axis revolution into the movement amount of the absolute-position detector (L_p) is as follows:

$$L_p = \text{Amount of movement per rotation axis revolution (parameter No. 141)} \times K \\ \times \text{Denominator for the number of pulses per motor revolution (parameter No. 106)} \times 2^{16} \\ \div \text{Numerator for the number of pulses per motor revolution (parameter No. 105)}$$

Currently, if either of the following two conditions is satisfied during the above conversion, L_p contains a fractional part. Because the servo amplifier module rounds off L_p to the nearest integer value, fractional parts are accumulated if revolution in one direction continues, possibly causing a positional error the next time the power is turned on.

(Condition 1) If K is less than 1, the "amount of movement per rotation axis revolution (parameter No. 141) $\times K$ " contains a fractional part.

(Condition 2) L_p contains a fractional part.

If either of the conditions is satisfied and the use of the servo amplifier module involves continuous revolution in one direction, you can set bit 6 (MVZPFR) of parameter No. 011 to 1. Even if a fractional part exists, this parameter setting makes allowance for the fractional part, and can prevent a positional error from occurring. However, you should see the description of bit 6 (MVZPFR) of parameter No. 011 because there are limitations on the use of the parameter.

NOTE

- 1 If K is equal to or greater than 2, servo alarm No. 405 may be issued during reference position return. In this case, set N405 (bit 4 of parameter No. 0001) to "1" to prevent the alarm from being issued.
- 2 When $K > 48$, bit 6 (ECMR) of parameter No. 010 to 1, and set the expanded command multiplier (EXCMR) in parameter No. 138. Up to 200 can be specified for K.

	No	
	070	Current loop gain (PK1)
[Size]	2-byte	
[Valid data range]	1 to 32767	
		Do not change the standard setting.
	No	
	071	Current loop gain (PK2)
[Size]	2-byte	
[Valid data range]	-1 to -32768	
		Do not change the standard setting.
	No	
	072	Current loop gain (PK3)
[Size]	2-byte	
[Valid data range]	-1 to -32768	
		Do not change the standard setting.
	No	
	073	Velocity loop gain (PK1V)
[Size]	2-byte	
[Valid data range]	1 to 32767	
	No	
	074	Velocity loop gain (PK2V)
[Size]	2-byte	
[Valid data range]	-1 to -32768	
	No	
	075	Velocity loop gain (PK4V)
[Valid data range]	-1 to -32768	
		Do not change the standard setting.

	No	
	078	Current compensation 1 (PVPA)
[Size]	2-byte	
[Valid data range]	-1 to -32768	
		Do not change the standard setting.
	No	
	079	Current compensation 2 (PALPH)
[Size]	2-byte	
[Valid data range]	-1 to -32768	
		Do not change the standard setting.
	No	
	080	Current limit value (TQLIM)
[Size]	2-byte	
[Valid data range]	0 to 7282	
		Do not change the standard setting.
	No	
	081	Overload protection coefficient (POVC1)
[Size]	2-byte	
[Valid data range]	0 to 32767	
		This is a coefficient for an alarm used to protect the motor and servo amplifier from overload.
		Do not change the standard setting.
	No	
	082	Overload protection coefficient (POVC2)
[Size]	2-byte	
[Valid data range]	0 to 32767	
		This is a coefficient for an alarm used to protect the motor and servo amplifier from overload.
		Do not change the standard setting.
	No	
	083	Overload protection coefficient (POVCLM)
[Size]	2-byte	
[Valid data range]	0 to 32767	
		This is a coefficient for an alarm used to protect the motor and servo amplifier from overload.
		Do not change the standard setting.
	No	
	084	Current compensation 3 (AALPH)
[Size]	2-byte	
[Valid data range]	0 to 32767	
		Do not change the standard setting.

	No	
	085	Actual current limit (DBLIM)
[Size]	2-byte	
[Valid data range]	0 to 32767	
		Do not change the standard setting.
	No	
	086	Current compensation 4 (MGSTCM)
[Size]	2-byte	
[Valid data range]	0 to 32767	
		Do not change the standard setting.
	No	
	087	Current compensation 5 (DETQLM)
[Size]	2-byte	
[Valid data range]	0 to 32767	
		Do not change the standard setting.
	No	
	088	Current compensation 6 (NINTCT)
[Size]	2-byte	
[Valid data range]	0 to 32767	
		Do not change the standard setting.
	No	
	089	Current compensation 7 (MFWKCE)
[Size]	2-byte	
[Valid data range]	0 to 32767	
		Do not change the standard setting.
	No	
	090	Current compensation 8 (MFWKBL)
[Size]	2-byte	
[Valid data range]	0 to 32767	
		Do not change the standard setting.
	No	
	091	VCMD polyline speed (P_VCLN)
[Size]	2-byte	
[Unit of data]	0.01 min ⁻¹	
[Valid data range]	0 to 32767	
		Setting the parameter to a positive value enables the VCMD polyline function.
		If the actual speed of the motor is lower than the speed specified in this parameter, the position loop gain is doubled, thus accelerating positioning.

	No	
	092	Low-speed integration threshold speed (P_LVIN)
[Size]	2-byte	
[Unit of data]	0.01min ⁻¹	
[Valid data range]	0 to 32767	
	When the low-velocity integration function is enabled, and an actual motor speed becomes higher than the speed set with this parameter, the integration term of the velocity loop becomes 0.	
	No	
	093	Estimated load torque: torque offset compensation
[Size]	2-byte	
[Unit of data]	Torque command unit	
[Valid data range]	-7282 to 7282 (7282 is the maximum current value of the amplifier)	
	The setting is added to an estimated load torque, thereby eliminating an effect of stationary torque including gravity.	
	No	
	094	Estimated load torque: dynamic friction compensation coefficient
[Size]	2-byte	
[Unit of data]	Torque command unit	
[Valid data range]	0 to 7282 (7282 is the maximum current value of the amplifier)	
[Setting value]	An estimated load torque at 1000 min ⁻¹ is measured and set. The compensation proportional to the speed is added to the estimated load torque, thereby eliminating an effect of dynamic friction.	
	No	
	095	Unexpected disturbance torque detection: retract distance
[Size]	2-byte	
[Unit of data]	Detection unit	
[Valid data range]	0 to 65535	
[Setting value]	Set approximately 3 mm.	
	No	
	096	Unexpected disturbance torque detection: alarm threshold value
[Size]	2-byte	
[Unit of data]	Torque command unit	
[Valid data range]	0 to 7282 (7282 is the maximum current value of the amplifier)	
	Set a limit (threshold) value at which an unexpected disturbance torque detection alarm is issued. If the setting is 0, processing for unexpected disturbance torque detection is disabled, and alarm detection and calculation of an estimated load torque are not performed. First set bit 1 (TDOU) of parameter No. 014 to 1 (bit 0 of parameter No.014 must be 0), and observe load torque. Then, set parameter No. 096 to a value greater than the maximum torque value.	

	No	
	099	Current compensation 9 (EMFCMP)
[Size]	2-byte	
[Valid data range]	-32768 to 32767	
		Do not change the standard setting.

	No	
	100	Load inertia ratio (LDINT)
[Size]	2-byte	
[Valid data range]	0 to 32767	
[Setting value]		The standard setting range is 0 to 1024. This parameter specifies the ratio of the machine load inertia to the motor inertia using a value calculated with the following formula as a guideline:

$$\text{Load inertia ratio} = \frac{\text{Machine load inertia}}{\text{Motor inertia}} \times 256$$

Setting this value causes speed loop gains PK1V and PK2V to be multiplied by: $1 + \text{LDINT}/256$

Setting the parameter to a larger value makes response to speed commands quicker and servo rigidity higher. If the parameter is set to an excessively large value, the servo system may vibrate, and noise may arise, during machine movement.

Usually, the parameter should not be set to more than 500.

If the machine vibrates at a high frequency, the torque command filter parameter (No.102) can be used to solve this.

	No	
	101	Acceleration feedback (PK2VAUX)
[Size]	2-byte	

This parameter can be used to suppress vibration. If used, it should be set to a value from -10 to -20.

No	
102	Torque command filter (FILTER)
[Size]	2-byte
[Valid data range]	0 to 2500
[Standard value]	0
	This parameter can be used to remove the high-frequency noise induced by a torque command. If the machine vibrates at a high frequency, the use of this parameter may suppress the vibration. The following table lists the relationships between the values specified for the parameter and the corresponding cut-off frequencies.

Cut-off frequency (Hz)	Parameter value
200	1166
150	1596
100	2185
80	2478

The lower the cut-off frequency (the larger the parameter-specified value), the stronger the filter effect. Specifying a filter with an excessively strong effect leads to unstable position control.

First, try a 150 Hz filter (set the parameter to 1596). If this does not suppress high-frequency vibration effectively, increase the parameter value by about 200 and note the effect. Repeat this until the desired effect is obtained, but do not exceed 2500.

No	
103	Feed-forward coefficient (FALPH)
[Size]	2-byte
[Unit of data]	%
[Valid data range]	0 to 100
[Standard value]	0
	This is a feed-forward coefficient parameter. 100 specified in the parameter corresponds to a coefficient of 1 (100%).

		No	
		104	Velocity feed-forward coefficient (VFFLT)
	[Size]	2-byte	
	[Valid data range]	0 to approximately 400	
	[Standard value]	0	
		This is a velocity feed-forward coefficient parameter. For a motor with no load, 100 specified in the parameter corresponds a coefficient of 1 (100%).	
		If a load inertia is added, set the parameter to a proportionally larger coefficient.	

Example)

If the load inertia is doubled:

To set velocity feed-forward to 100%: $100 \times (1 + 2) = 300$

To set velocity feed-forward to 50%: $50 \times (1 + 2) = 150$

		No	
		105	Numerator for the number of pulses per motor revolution (SDMR1)
	[Size]	2-byte	
	[Valid data range]	0 to 32767	
	[Standard value]	10000	
		This parameter specifies the number of pulses per motor revolution for a detection increment, together with parameter No. 106. To be specific, this parameter is used as a numerator.	

NOTE

To set the number of pulses per motor revolution to a value greater than 32767, set this parameter to 0, and specify that number in parameter No. 179. Up to 8388607 pulses can be specified.

No	Denominator for the number of pulses per motor revolution (SDMR2)
106	
[Size]	2-byte
[Valid data range]	1 to 32767
[Standard value]	1
	This parameter is used as a denominator for the number of pulses per motor revolution detection increment. The number of pulses (after CMR) per motor revolution is represented as: (No. 0105) (No. 0106)
	If the number of pulses per motor revolution is an integer, set parameter No. 0106 to 1.
	Example 1) If a detection increment is set to 1 μ in a 10 mm/revolution ball screw machine: Set parameter No. 105 to 10000, and parameter No. 106 to 1, because the number of pulses per motor revolution is 10 mm/1 μ = 10000.
	Example 2) If the detection increment is 0.1° for a motor coupled directly to the rotation axis: Set parameter No. 105 to 360°, and parameter No. 106 to 1, because the number of pulses per motor revolution is 360° /0.1° = 3600.

NOTE

If the number of pulses per motor revolution (parameter No. 105/parameter No. 106) is remarkably small, a position gain overflow occurs, issuing an illegal parameter setting alarm (417). Check that the number of pulses per motor revolution is greater than the applicable lower limit given in the table below.

Value set for the position gain (No.0107)	Lower limit on the number of pulses per motor revolution
20	41
30	62
40	82

Formula) (Position gain)/(Number of pulses per motor revolution) < 0.488
If the number of pulses per motor revolution is below the applicable lower limit, increase the number of pulses per motor revolution to the lower limit or above, using the procedure below. In this case, the user unit is equal to 1/E and, therefore, the other parameters set with the user unit must be multiplied by E.

(Procedure)

Multiply CMR and the number of pulses per revolution by integer value E, so that the number of pulses per revolution is greater than the lower limit.

No. 032 \times E

No. 105 \times E \geq Lower limit

(Setting example)

If the position gain (parameter No. 107) is 30, CMR (parameter No. 32) is 2, and the number of pulses per motor revolution (Nos. 105 and 106) is 50/1, the lower limit is 62, causing an overflow to occur. Multiply CMR and the denominator for the number of pulses per motor revolution (No. 105) by two to change parameter 32 to 4 and parameter 105 to 100. (The user unit becomes 1/2.)

No	
107	Position loop gain (LPGINX)
[Size]	2-byte
[Valid data range]	1 to 32767
[Standard value]	30
	This parameter is related to a position loop time constant. The larger the value set for this parameter, the more quickly the NC responds to commands, and the less time is required for positioning. If the parameter is set to an excessively large value, however, hunting (at 5 to 15 Hz) may occur during movement, or overshoot may occur at a stop. Setting parameter No. 100 (load inertia ratio) to a larger value increases the range of the position loop gain values that can be set up.

No	
108	Servo motor torque limit
[Size]	2-byte
[Valid data range]	0 to 7282
[Standard value]	0
	Applying a torque limit to the servo motor enables positioning in reference to a mechanical stopper. Setting bit 2 of parameter No. 010 (IEBL) validates a torque limit based on this parameter. If 0 is specified for this parameter, 100% (7282) is assumed. Calculate the necessary setting, using:

$$\text{Value in parameter No. 108} = \text{torque limit value [\%]} \times \frac{7282}{100}$$

NOTE

This parameter is invalid during velocity control. To limit the torque during peripheral equipment control, use type B (bit 4 (VCTLB) of parameter No. 007 is 1).

	No	
	109	Backlash amount (BKLCMP)
[Size]	2-byte	
[Unit of data]	User-specified unit	
[Valid data range]	0 to 32767(Detection unit)	
[Standard value]	0	
	The parameter sets up a backlash amount (User unit). The range will be in the detection increment resulting from multiplying the user unit by the command multiplier (parameter No. 032).	
	No	
	110	Positional deviation limit value at a stop
[Size]	2-byte	
[Valid data range]	0 to 32767	
[Standard value]	500	
	This parameter sets a positional deviation limit value used when the motor is at a stop (detection increment). Alarm 410 is raised if the positional deviation limit is exceeded when the motor is at a stop.	
	No	
	111	In-position width
[Size]	2-byte	
[Valid data range]	0 to 32767	
[Standard value]	10	
	If the positional deviation becomes lower than the value specified in this parameter after the related block ends, an in-position signal is returned to the host.	
	No	
	112	Torque constant
[Size]	2-byte	
[Valid data range]	0 to 32767	
	Do not change the standard setting.	
	No	
	115	Model constant
[Size]	2-byte	
[Valid data range]	0 to 32767	
	Normally, the standard setting need not be changed. The setting should be adjusted only when an estimated load torque is correctly calculated during use of the unexpected disturbance torque detection function.	

		No	
		116	Velocity loop gain override during velocity control (%)
[Size]		2-byte	
[Standard value]		0 (overriding not performed)	
		Set this parameter if the system is switched between position control and velocity control.	
		<p>When the system enters velocity control mode, the velocity loop proportional gain and the integral gain that are used in position control are multiplied by the above override.</p> <p>The relationships among the velocity loop proportional gain, integral gain, load inertia ratio, and the velocity loop gain override during velocity control are explained using the following example:</p> <p>Assume the following:</p> <p>Integral gain = 100</p> <p>Proportional gain = -500</p> <p>Load inertia ratio = 128</p> <p>Velocity loop gain override during velocity control = 200%</p> <p>[Gain during position control]</p> <p>Integral gain = $100 \times (1+128/256) = 150$</p> <p>Proportional gain = $-500 \times (1+128/256) = -750$</p> <p>[Gain during velocity control]</p> <p>Integral gain = $100 \times (1+128/256) 200/100 = 300$</p> <p>Proportional gain = $-500 \times (1+128/256) 200/100 = -1500$</p> <p>Thus, the gain with the load inertia ratio taken into consideration is multiplied by the gain override during velocity control.</p>	
		No	
		118	Current compensation 10 (PHDLY1)
[Size]		2-byte	
[Valid data range]		0 to 32767	
		Do not change the standard setting.	
		No	
		119	Current compensation 10 (PHDLY2)
[Size]		2-byte	
[Valid data range]		0 to 32767	
		Do not change the standard setting.	

	No	
	125	Motor type number
[Size]	2-byte	
[Valid data range]	1 to 350	
	Set the type number of a motor to use. Ensure that parameter No.30 is 0.	

The models, drawing numbers, and type numbers of the motors that can be used with the β_i SVM are listed below.

SVM1-4i

Motor model	$\beta 0.2/5000is$	$\beta 0.3/5000is$
Motor specification	0111	0112
Motor type number	260	261

SVM1-20i

Motor model	$\alpha 1/5000i$	$\beta 2/4000is$	$\alpha 2/5000i$	$\beta 4/4000is$	$\beta 8/3000is$
Motor specification	0202	0061	0205	0063	0075
Motor type number	252	253	255	256	258
Motor model	$\alpha 2/5000is$	$\alpha 4/5000is$	$\alpha C4/3000i$	$\alpha C8/2000i$	$\beta 0.4/5000is$
Motor specification	0212	0215	0221	0226	0114
Motor type number	262	265	271	276	280
Motor model	$\beta 0.5/5000is$	$\beta 1/5000is$	$\alpha C12/2000i$		
Motor specification	0115	0116	0241		
Motor type number	281	282	291		

SVM1-40i

Motor model	$\beta 12/3000is$	$\alpha 4/4000i$	$\beta 22/2000is$	$\alpha 8/3000i$	$\alpha C22/2000i$
Motor specification	0078	0223	0085	0227	0246
Motor type number	272	273	274	277	296

SVM1-80i

Motor model	$\alpha 8/4000is$	$\alpha 12/4000is$	$\alpha 12/3000i$	$\alpha 22/3000i$	$\alpha C30/1500i$
Motor specification	0235	0238	0243	0247	0251
Motor type number	285	288	293	297	301

	No	
	130	Unexpected disturbance torque detection alarm timer
[Size]	2-byte	
[Unit of data]	msec	
[Valid data range]	0 to 32767 (200 msec if 0 is set)	
	Set the time from when an unexpected disturbance torque is detected to when a servo alarm is issued. A fraction smaller than 8 msec is rounded up.	
	Example) Setting of 30: assumed to be 32 msec	
	No	
	135	Linear acceleration/deceleration time constant for velocity control
[Size]	2-byte	
[Unit of data]	ms	
[Valid data range]	8 to 4000	
	Specify the time required to reach 4000 min ⁻¹ .	
	Example)	
	If the value specified for velocity is 2000 min ⁻¹ , and the time required to reach 2000 min ⁻¹ is to be 1000 msec, the value to be set is calculated as follows:	
	Value to be set = (4000/2000) × 1000 = 2000	
	No	
	136	Velocity deviation check limit during velocity control
[Size]	2-byte	
[Unit of data]	min ⁻¹	
[Valid data range]	0 to 4000	
[Standard value]	0 (velocity deviation check not performed)	
	Set the limit on the velocity deviation check to be performed in velocity control mode.	
	In velocity control mode, alarm No. 447 is issued if the deviation of the actual velocity from the specified velocity exceeds the value set for this parameter.	
	No	
	137	Effective area for in-position check during cutting feed
[Size]	2-byte	
[Valid data range]	0 to 32767	
[Standard value]	10	
	Set an effective area for in-position check during cutting feed.	
	This parameter is valid when bit 3 (CIPC) and bit 7 (CSMZ) of parameter No.002 are 1, and RPD is 0 and SMZX is 1 for function code 0x61 or 0x62.	

No	
138	Expanded command multiplier (EXCMR)
[Size]	2-byte
[Valid data range]	2 to 400
[Standard value]	0
	Specify a ratio of the user-specified unit to the detection unit.
	$K = \frac{\text{User-specified unit}}{\text{Detection unit}} \quad (K \geq 1)$
	EXCMR = 2 × K
	Enter an EXCMR value according to the above formula. Note that K can be a value of 1 to 200.

NOTE

- 1 Always set an even number for EXCMR.
- 2 When $K < 1$, set bit 6 (ECMR) of parameter No. 010 to 0, and set the command multiplier in parameter No. 032.
- 3 See the notes on parameter No. 032 because they are also related to this parameter.
- 4 When bit 6 (ECMR) of parameter No. 010 is 1, read parameter No. 032 in this manual as parameter No. 138.

No	
179	Numerator for the number of pulses per motor revolution
[Size]	4-byte
[Valid data range]	0 to 8388607
[Standard value]	0
	For the numerator for the number of pulses per motor revolution, the setting of parameter No. 179 is valid when parameter No. 105 is 0. When parameter No. 105 is a nonzero value, the value of parameter No. 105 is valid.
	For the denominator for the number of pulses per motor revolution, the setting of parameter No. 106 is always valid.

NOTE

- 1 If parameter No. 105 is 0 and parameter No. 179 is greater than 8388607, an illegal parameter setting alarm (417) is issued.
- 2 If parameter No. 105 is 0 and parameter No. 179 is smaller than parameter No. 106, an illegal parameter setting alarm (417) is issued.
- 3 See the notes on parameter No. 105 because they are also related to this parameter.
- 4 When this parameter is valid (parameter No. 105 is 0), read parameter No. 105 in this manual as parameter No. 179.

	No	
	180	Reference counter capacity
[Size]	4-byte	
[Valid data range]	1 to 99999999	
[Standard value]	10000	
	This parameter specifies a reference counter capacity. Reference counter capacity = number of pulses per motor revolution (detection increment)	
	No	
	181	Grid shift amount
[Size]	4-byte	
[Valid data range]	0 to ±99999999	
[Standard value]	0	
	A grid position can be shifted by the amount specified in this parameter so that the reference position can be shifted. The unit of shift is a detection increment. The maximum grid shift amount that can be specified is half or less than the reference counter capacity.	
	No	
	182	Positional deviation limit value during movement
[Size]	4-byte	
[Valid data range]	0 to 99999999	
[Standard value]	3333	
	This parameter specifies a positional deviation limit value used when the motor is rotating. Alarm No. 411 is raised, if this value is exceeded, leading to deceleration and stop.	

B.7 DIGITAL SERVO STANDARD PARAMETER TABLE

March, 2004

Motor model	$\alpha 1$	$\beta 2$	$\alpha 2$	$\beta 4$	$\beta 8$	$\beta 0.2$	$\beta 0.3$	$\alpha 2$	
Motor specification	5000 <i>i</i>	4000 <i>is</i>	5000 <i>i</i>	4000 <i>is</i>	3000 <i>is</i>	5000 <i>is</i>	5000 <i>is</i>	5000 <i>is</i>	
Symbol	0202	0061	0205	0063	0075	0111	0112	0212	
Motor ID No.	252	253	255	256	258	260	261	262	
BITPRM	19	00001000	00001100	00001000	00001100	00001100	00000000	00000000	00001000
PK1	70	620	360	760	400	650	123	210	530
PK2	71	-3034	-1920	-3743	-1920	-3831	-510	-970	-2543
PK3	72	-1256	-1237	-1283	-1253	-1299	-1069	-1146	-1251
PK1V	73	64	76	74	109	160	4	4	38
PK2V	74	-580	-681	-664	-984	-1441	-35	-32	-341
PK4V	75	-8235	-8235	-8235	-8235	-8235	-8235	-8235	-8235
PPMAX	76	21	21	21	21	21	21	21	21
PDDP	77	1894	1894	1894	1894	1894	1894	1894	1894
PVPA	78	0	-10250	-12298	-7694	-5140	0	0	-10250
PALPH	79	0	-1000	-1275	-2800	-3200	0	0	-2000
TQLIM	80	7282	6554	7282	7282	7282	7282	7282	7282
POVC1	81	32692	32652	32635	32532	32385	32583	32583	32650
POVC2	82	948	1455	1664	2945	4788	2312	2312	1475
POVCLMT	83	2812	4317	4941	8758	14271	6869	6869	4379
AALPH	84	20480	16384	12288	20480	16384	20480	20480	20480
DBLIM	85	0	0	0	0	0	0	0	0
MGSTCM	86	32	1048	32	780	1807	1	1	32
DETQLM	87	10260	11600	10280	7790	7930	7710	7700	8995
NINTCT	88	1188	1172	1276	796	1442	379	852	1137
MFWKCE	89	1667	2500	2000	3000	3500	0	3000	1000
MFWKBL	90	3858	3358	3862	3392	1298	0	3880	3851
EMFCMP	99	-5130	0	-10	0	-2570	0	0	0
PK2VAUX	101	0	0	0	0	0	0	0	0
TRQCST	112	72	119	109	146	226	7	14	117
MDLCST	115	1088	1856	951	1284	877	18132	19686	1844
PHDLY1	118	7690	7192	7693	8992	3858	7700	7695	7690
PHDLY2	119	12840	8990	12840	12864	8990	12825	12840	12840

Motor model	$\alpha 4$	$\alpha C4$	$\beta 12$	$\alpha 4$	$\beta 22$	$\alpha C8$	$\alpha 8$	$\beta 0.4$	
Motor specification	5000 <i>is</i>	3000 <i>i</i>	3000 <i>is</i>	4000 <i>i</i>	2000 <i>is</i>	2000 <i>i</i>	3000 <i>i</i>	5000 <i>is</i>	
Symbol	0221	0078	0078	0223	0085	0226	0227	0114	
Motor ID No.	265	271	272	273	274	276	277	280	
BITPRM	19	00001000	00001000	00001100	00000000	00001100	00001000	00000000	00000000
PK1	70	420	1240	402	993	1184	1276	787	100
PK2	71	-1748	-6415	-2217	-4260	-6800	-6288	-4184	-430
PK3	72	-1276	-1309	-1304	-1311	-1331	-1326	-1325	-2463
PK1V	73	63	113	166	104	236	146	110	7
PK2V	74	-560	-1009	-1494	-931	-2121	-1310	-985	-59
PK4V	75	-8235	-8235	-8235	-8235	-8235	-8235	-8235	-8235
PPMAX	76	21	21	21	21	21	21	21	21
PDDP	77	1894	1894	1894	1894	1894	1894	1894	1894
PVPA	78	-8974	-5915	-5140	-11789	-3612	-3854	-6420	0
PALPH	79	-3641	-1500	-3500	-180	-3000	-1236	-2000	0
TQLIM	80	7282	7282	7282	8010	7282	7282	8010	4660
POVC1	81	32373	32590	32491	32610	32428	32434	32579	32640
POVC2	82	4942	2225	3465	1979	4249	4170	2363	1603
POVCLMT	83	14731	6612	10311	5879	12656	12420	7020	4759
AALPH	84	12288	12288	16384	8192	16384	8192	8192	20480
DBLIM	85	0	0	0	15000	0	0	15000	0
MGSTCM	86	8	1289	1814	32	0	1552	776	30
DETQLM	87	10295	3900	7930	5130	2866	3880	3870	10290
NINTCT	88	646	2544	1194	1443	2459	2380	2103	400
MFWKCE	89	1667	5000	3000	2000	5000	4500	3500	0
MFWKBL	90	3847	1812	2056	3338	562	1550	1815	0
EMFCMP	99	0	0	0	-5130	-5130	0	0	-12850
PK2VAUX	101	0	0	0	0	0	0	0	0
TRQCST	112	127	190	418	201	692	277	369	22
MDLCST	115	1127	626	845	678	596	482	641	10651
PHDLY1	118	7690	3855	5138	6670	3350	3860	0	7690
PHDLY2	119	12840	8995	8990	8980	8979	8990	0	12820

Motor model		$\beta 0.5$	$\beta 1$	$\alpha 8$	$\alpha 12$	$\alpha C12$	$\alpha 12$	$\alpha C22$	$\alpha 22$
Motor specification		5000 <i>i</i> s	5000 <i>i</i> s	4000 <i>i</i> s	4000 <i>i</i> s	2000 <i>i</i>	3000 <i>i</i>	2000 <i>i</i>	3000 <i>i</i>
Symbol	Motor ID No.	281	282	285	288	291	293	296	297
BITPRM	19	00000000	00000000	00001000	00001000	00000000	00000000	00001000	00000000
PK1	70	88	318	550	570	1875	1701	2320	1750
PK2	71	-818	-1819	-3449	-3358	-9137	-6391	-10593	-6000
PK3	72	-2415	-2388	-1307	-1319	-1339	-1315	-1347	-1345
PK1V	73	6	6	32	51	273	188	264	194
PK2V	74	-57	-51	-287	-454	-2445	-1681	-2368	-1733
PK4V	75	-8235	-8235	-8235	-8235	-8235	-8235	-8235	-8235
PPMAX	76	21	21	21	21	21	21	21	21
PDDP	77	1894	1894	1894	1894	1894	1894	1894	1894
PVPA	78	0	-11525	-7685	-5898	-1804	-8199	-2597	-5136
PALPH	79	0	-500	-2000	-3000	-2500	-747	-1942	-2800
TQLIM	80	5826	6554	7282	7282	7282	7282	8010	7282
POVC1	81	32674	32695	32690	32653	32317	32552	32348	32542
POVC2	82	1178	915	978	1435	5644	2702	5248	2820
POVCLMT	83	3497	2714	2901	4259	16838	8031	15648	8384
AALPH	84	20480	20480	0	0	8192	8192	4096	12288
DBLIM	85	0	0	0	0	15000	15000	0	15000
MGSTCM	86	30	30	519	521	0	32	1548	1291
DETQLM	87	10290	10290	7268	6174	2168	0	2600	0
NINTCT	88	1009	1763	2106	1592	4150	2388	3695	3272
MFWKCE	89	0	0	4000	2000	12000	2000	4000	4500
MFWKBL	90	0	0	2580	2575	1044	2568	1046	1301
EMFCMP	99	-12850	-12850	0	0	0	0	0	0
PK2VAUX	101	0	0	0	0	0	0	0	0
TRQCST	112	42	89	562	696	350	517	680	929
MDLCST	115	11014	12232	2197	1389	258	376	267	364
PHDLY1	118	7690	11560	5150	6174	5150	0	2070	0
PHDLY2	119	12820	12880	8990	8990	8990	0	9000	0

Motor model		$\alpha C30$
Motor specification		1500 <i>i</i>
Symbol	Motor ID No.	301
BITPRM	19	00001000
PK1	70	2238
PK2	71	-13330
PK3	72	-1347
PK1V	73	162
PK2V	74	-1451
PK4V	75	-8235
PPMAX	76	21
PDDP	77	1894
PVPA	78	-1545
PALPH	79	-1300
TQLIM	80	7282
POVC1	81	32632
POVC2	82	1704
POVCLMT	83	5058
AALPH	84	8192
DBLIM	85	0
MGSTCM	86	2059
DETQLM	87	2148
NINTCT	88	6680
MFWKCE	89	14000
MFWKBL	90	539
EMFCMP	99	0
PK2VAUX	101	0
TRQCST	112	1630
MDLCST	115	435
PHDLY1	118	1054
PHDLY2	119	9000

C

DIAGNOSIS LISTS

Diagnosis is carried out using the diagnosis screen of the power mate CNC manager on the host.

C.1 SIGNALS SENT FROM CNC (HOST) TO SERVO AMPLIFIER MODULE

C.1.1 Peripheral Equipment Control Interface (DRC = 0)

(DGN No.)	7	6	5	4	3	2	1	0
000	ST	UCPS2	-X	+X	DSAL	MD4	MD2	MD1
001			DRC	ABSRD	*ILK	SVFX	*ESP	ERS
002	Function code				Command data 1			
003	Command data 2							
004								
005								
006								
007	RT	DRN	ROV2 /MP2	ROV1 /MP1	*OV8	*OV4	*OV2	*OV1

C.1.2 Direct Command Interface (DRC = 1)

(DGN No.)	7	6	5	4	3	2	1	0
000	ST		-X	+X		MD4	MD2	MD1
001			DRC	WFN	*ILK	SVFX	*ESP	ERS
002	RT	DRN	ROV2	ROV1	*OV8	*OV4	*OV2	*OV1
003	INPF							
004	EBUF	EOREND						ECNT
005	Direct command (function code)							
006	Direct command (command data 1)							
007	Direct command (command data 2)							
008	Direct command (command data 3)							
009	Direct command (command data 4)							
010	Direct command (command data 5)							
011	Direct command (command data 6)							
012	Direct command (command data 7)							
013	Direct command (command data 8)							
014	Direct command (command data 9)							
015	Direct command (command data 10)							

NOTE

- 1 DGN numbers 000 to 015 correspond to signal addresses Yy+ 0 to Yy+15, respectively.
- 2 DGN numbers 008 to 015 (signal addresses Yy+8 to Yy+15) are not used for the peripheral equipment control interface.
- 3 See Section 2.2 of Part II for details of the signals.

C.2 SIGNALS SENT FROM SERVO AMPLIFIER MODULE TO CNC (HOST)

C.2.1 Peripheral Equipment Control Interface (DRC = 0)

(DGN No.)	7	6	5	4	3	2	1	0
016	OPC4	OPC3	OPC2	OPC1	INPX	SUPX	IPLX	DEN2
017	OP	SA	STL	UCPC2	OPTENB	ZRFX	DRCO	ABSWT
018	MA	AL	DSP2	DSP1	DSALO	TRQM	RST	ZPX
019	Response data							
020								
021								
022								
023								

C.2.2 Direct Command Interface (DRC = 1)

(DGN No.)	7	6	5	4	3	2	1	0
016					INPX	SUPX	IPLX	DEN2
017	OP	SA	STL		OPTENB	ZRFX	DRCO	WAT
018	MA	AL				TRQM	RST	ZPX
019	INPFO	SVERX		PSG2	PSG1	MVX	APBAL	MVDX
020	EBSY	EOSTB	ECF		USR1	EOPC	DAL	ECONT
021	Direct command (function code)							
022	Reserved				Execution result			
023	Direct command (response data 1)							
024	Direct command (response data 2)							
025	Direct command (response data 3)							
026	Direct command (response data 4)							
027	Direct command (response data 5)							
028	Direct command (response data 6)							
029	Direct command (response data 7)							
030	Direct command (response data 8)							
031	Direct command (response data 9)							

NOTE

- 1 DGN numbers 016 to 031 correspond to signal addresses Xx+0 to Xx+15, respectively.
- 2 DGN numbers 024 to 031 (signal addresses Xx+8 to Xx+15) in the peripheral equipment control interface are used as response area for the power mate CNC manager.
- 3 See Section 2.2 of Part II for details of the signals.

C.3 SERVO POSITIONAL DEVIATION AMOUNT (SERVO AMPLIFIER MODULE)

(DGN No.)

032

Servo positional deviation amount (servo amplifier module)

C.4 ACCELERATION/DECELERATION DELAY AMOUNT (SERVO AMPLIFIER MODULE)

(DGN No.)

033

Acceleration/deceleration delay amount (servo amplifier module)

C.5 FUNCTION BIT (SERVO AMPLIFIER MODULE)

(DGN No.)

034

#7	#6	#5	#4	#3	#2	#1	#0
				1	0	ABTDTC	1

ABTDTC The unexpected disturbance torque detection function is:
 0 : Disabled.
 1 : Enabled.

C.6 DIRECT INPUT SIGNAL STATUSES (SERVO AMPLIFIER MODULE)

(DGN No.)

035

#7	#6	#5	#4	#3	#2	#1	#0
*+OT	*-OT		HDI	*RILK/ *DEC		*ESP	

*ESP Status of an emergency stop signal
 *RILK/*DEC Status of a high-speed interlock signal (*RILK) or reference position return deceleration signal (*DEC)
 HDI Status of a skip signal
 *-OT Status of an overtravel signal (negative direction)
 *+OT Status of an overtravel signal (positive direction)

NOTE

The status of a reference position return deceleration signal (*DEC) and the status of a high-speed interlock signal (*RILK) are stored in the same bit position. When the function for reference position return with dogs is enabled (bit 2 (DZRN) of parameter No. 011 is 1), the *DEC status is indicated; when that function is disabled (DZRN is 0), the *RILK status is indicated.

D

POWER MATE CNC MANAGER FUNCTIONS

D.1 POWER MATE CNC MANAGER FUNCTIONS (Series 16, 18, 21, Power Mate)

D.1.1 Overview

This chapter explains the power mate CNC manager functions used by the CNC to set up and display the types of data for servo amplifier module.

The functions provided are:

- (1) Current position display (absolute/machine coordinate)
- (2) Parameter display and setting
- (3) Diagnosis
- (4) System configuration, amplifier ID
- (5) Alarm

NOTE

- 1 These functions may not be available depending on the CNC model or option with which they are used.
- 2 These functions cannot be used on the DPL/MDI.

D.1.2 I/O Link Connection

The CNC assigns I/O addresses for it. Because the CNC exchanges data with an servo amplifier module in 16-byte units, it is necessary to set the number of input/output points to 128. Up to eight servo amplifier module can be connected.

The names of modules used for I/O link connection are OC02I (16-byte input) and OC02O (16-byte output). The BASE and SLOT are always 0 and 1, respectively.

D.1.3 Function Selection and Termination

D.1.3.1 Selection

Each power motion manager function can be selected by first pressing the next-menu key (rightmost soft key) on the CNC system screen several times until [PMM] is displayed, then pressing this soft key. The initial screen, that is, the system configuration screen, for the power motion manager appears. On this screen, the desired function can be selected by pressing the corresponding soft key.

After a power motion manager function has been selected, if a function key on the MDI is pressed to select another function, then the <SYSTEM> function key is pressed, the previous screen of the function appears again. In this case, however, data being input has been canceled.

D.1.3.2 Function Selection Soft Key

When a power motion manager function is selected, its initial screen, that is, system configuration screen appears, and the following soft key menu is displayed (for a 9-inch CRT).

```

      1      2      3      4      5
[ POS ][      ][      ][ SYSTEM ][ MSG ]

```

The soft key for the currently selected screen is displayed in reverse video.

The soft keys of this menu are used to select the following functions.

POS : Current position display
 SYSTEM : System information screen, amplifier ID information
 MSG : Alarm list

After one of the above functions is selected, another function can be selected by pressing the previous-menu key (leftmost soft key) several times until this soft key menu appears, then pressing the soft key for the desired function in the menu.

D.1.3.3 Termination

When the leftmost soft key is pressed to display the function selection keys described in Section D.1.3.2, then the previous-menu key is pressed, the soft key menu for the CNC system appears, and the power motion manager function is terminated. At this point, the system configuration screen for the power motion manager functions is displayed as the end screen.

After a power motion manager function is selected, another function can be selected by pressing the corresponding function key (POS, PROG, MESSAGE, etc.) on the MDI.

D.1.3.4 Disabling the Power Mate CNC Manager Functions

Once the data necessary for a connected servo amplifier module has been set up or confirmed, it is possible to discontinue communication with the power mate CNC manager (PMM) to give priority to those commands sent from the ladder program of the CNC to slaves. This is done by setting bit 3 of parameter P960 to 1.

Communication between the CNC and a servo amplifier module via an FANUC I/O Link is surrendered to the ladder program.

When this parameter is 1, only communication-independent items, such as a title and function name, are displayed on the screen. The following message appears to indicate that communication has been discontinued.
 COMMUNICATION PROHIBITED BY P960#3

D.1.3.5 Parameter Setting

So that the power motion manager functions can run properly, it is necessary to set the following data on the CNC parameter screen.

Parameter P960

- (1) Bit 0 (SLV) (screen display)
 - 0 : One slave per screen
 - 1 : Four slaves per screen

- (2) Bits 1 and 2 (MD1 and MD2) (data input/output destinations)

Bit 2	Bit 1	
MD2	MD1	
0	0	CNC memory (NOTE)
0	1	Memory card

- (3) Bit 3 (PMM) (whether to disable the PMM)
 - 0 : Enable
 - 1 : Disable

- (4) Bit 4 (SLPWE) (parameter write protection)
 - 0 : The Power Mate CNC manager can always be used to set parameters for the servo amplifier module.
 - 1 : Whether the Power Mate CNC manager can be used to set parameters for the servo amplifier module depends on the setting of PWE of the host CNC.

- (5) Bit 5 (ASG) (check of the number of bytes for an assigned I/O address)
 - 0 : No check is made to determine whether the number of bytes for an I/O address assigned to the servo amplifier module is 16.
 - 1 : A check is made to determine whether the number of bytes for an I/O address assigned to the servo amplifier module is 16.

- (6) Bit 6 (2CH) (communication channel setting)
 - 0 : When two I/O Link channels are provided, the Power Mate CNC manager communicates with the second channel. (If a servo amplifier module is not connected to the second channel, the manager communicates with the first channel.)
 - 1 : When two I/O Link channels are provided, the Power Mate CNC manager communicates with the first channel. When only one I/O Link channel is provided, the manager communicates with that channel.

- (7) Bit 7 (DRC)
 - 0 : While positions are being displayed on one-screen view, a direct command cannot be specified. (Peripheral equipment control can be performed.)
 - 1 : While positions are being displayed on one-screen view, a direct command can be specified. (Coordinates are updated at longer intervals.)

NOTE

A data file is saved as a program to a memory area.
The CNC program list screen can be used to check
which memory area is used for a particular data file.

***D.1.3.6* Restriction**

When a power motion manager function is used, it is impossible to use an FANUC I/O Link-based data input/output function.

D.1.4 Function Overview

D.1.4.1 Soft key status transition diagram

This manual focuses on the soft keys designed for use on the 9-inch CRT. For operation with the 14-inch CRT, follow the descriptions for the 9-inch CRT while referring to the status transition diagram for the 14-inch CRT, provided in item (2).

- (1) Status transition diagram for the soft keys designed for use on the 9-inch CRT

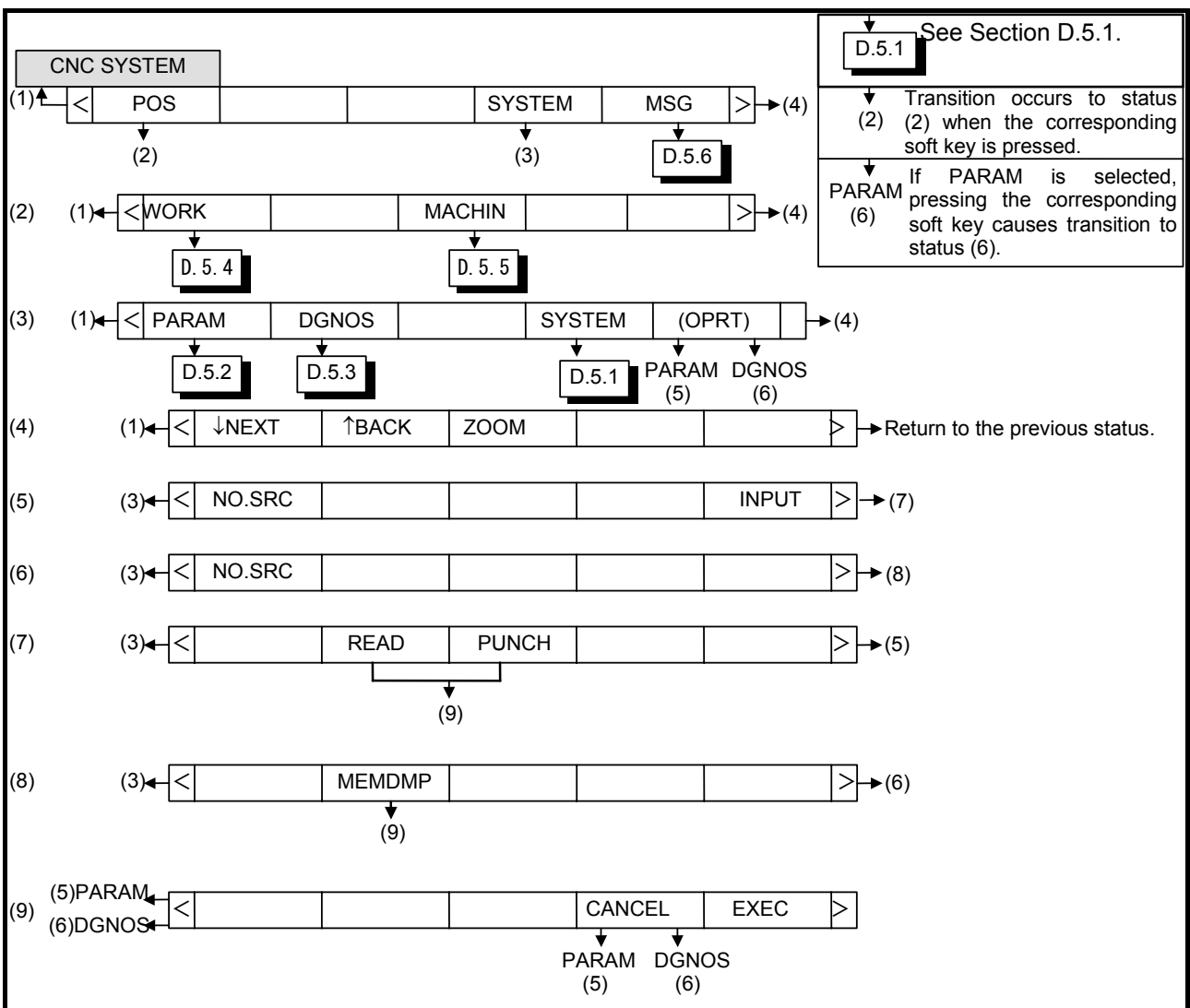

(2) Status transition diagram for the soft keys designed for use on the 14-inch CRT

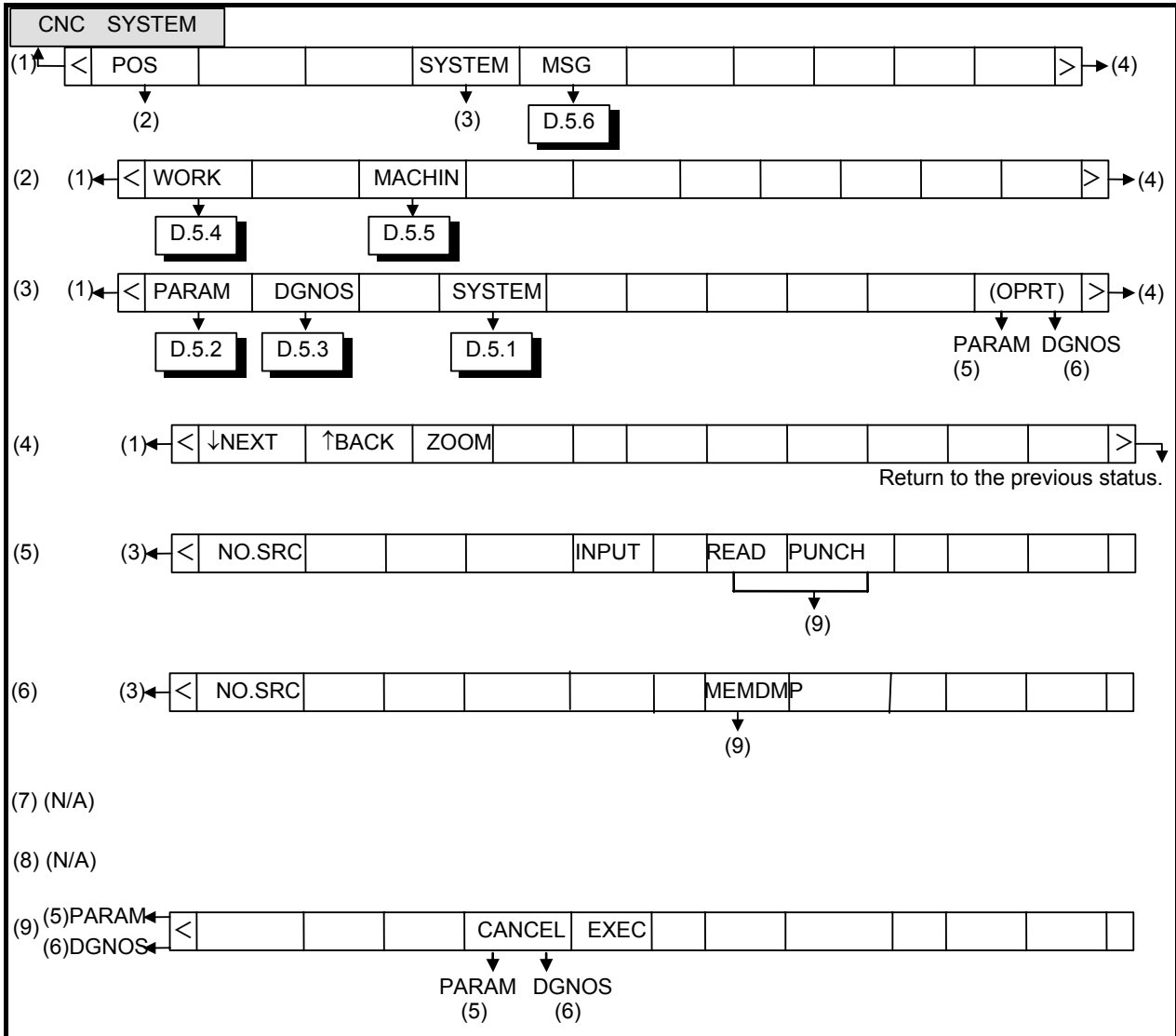

(3) Display screen

If a soft key from (2) to (4) is pressed, the corresponding screen appears. Pressing the previous-menu key resumes the function selection soft key menu. Pressing the previous-menu key again switches the display screen and soft keys to the CNC system screen and terminates the power motion manager function.

D.1.4.2 Screen configuration

(1) Selecting an active slave

The term "active slave" refers to the servo amplifier module that is a target of the zoom and parameter write functions explained in (2). The title of an active slave is displayed in a different color from other servo amplifier module.

An active slave can be selected using the [O NEXT] and [= BACK] soft keys displayed by pressing the next-menu key several times.

[↓ NEXT]: Displays the screen for a servo amplifier module connected ahead of the current servo amplifier module. Equipment other than servo amplifier module is ignored.

[↑ BACK]: Displays the screen for a servo amplifier unit connected behind the current servo amplifier module.

(2) Single-slave display and four-slave display

A parameter can select whether to display data about a single slave on one screen or data about four slaves on one screen at a time. See Section D.1.3.5 for details of how to set data.

If a four-slave display is on the screen, pressing the [ZOOM] soft key, which is displayed by pressing the next-menu key several times, causes switching to single-slave display for the active slave. If a single-slave display is on the screen, pressing [ZOOM] will cause switching to a four-slave display that contains data about the active slave.

If there are more than four slaves, those slaves that are not included in the current four-slave display page are displayed on the subsequent pages. Data about a desired slave may be viewed using the [↓ NEXT] soft key to switch the active slave.

POWER MATE CNC MANAGER / SYSTEM CONFIGURATION									
1. GROUP0 /β	2. GROUP1 /β								
SYSTEM 88A1 01	SYSTEM 88A1 01								
3. GROUP2 /β	4. GROUP3 /β								
SYSTEM 88A1 01	SYSTEM 88A1 01								
SELECT ACTIVE SLAVE [→]									
PARAM	DGNOS	SYSTEM							

This example shows a four-slave display on the 14-inch CRT. A four-slave display can also be presented on the 9-inch CRT.

```

POWER MATE CNC MANAGER
SYSTEM CONFIGURATION
1. GROUP 0 / B I

SYSTEM      (SERIES/VERSION)    8 8 A 6      0 1

AXIS NAME           X 1
I/O CH-GROUP       1- 1
AMP NUMBER          A 1-L
UNIT KIND           SVM
MAX CURRENT         20A
SERVO AMP SPEC.    A 0 6 B-6 1 3 0-H 0 0 2
SERVO AMP S/N      V 0 3 7 0 9 4 2 4

SELECT ACTIVE SLAVE [ > ]
[PARAM ] [DGNOS ] [ ] [SYSTEM] [ ]
    
```

This example shows a single-slave display on the 9-inch CRT. A single-slave display can also be presented on the 14-inch CRT.

(3) Guidance messages

The following table lists the guidance messages that appear on the message line when soft keys are displayed. See Section D.1.4.1 for details of soft keys (1) to (9).

If, however, an alarm occurs in the power mate CNC manager, its number and message are displayed. See Section D.1.6 for details.

Soft key	Message
(1) to (3)	SELECT ACTIVE SLAVE[>]
(4)	SELECT ACTIVE SLAVE[↓][↑]
(5) to (9)	No message is displayed, because these soft keys have the same functions as in the existing CNC software. The message line is used as a key-in line to display the entered data.

(4) Key-in line

After the [(OPRT)] soft key is pressed, the message line becomes the key-in line, as required. The key-in line displays numeric data keyed in, from the MDI keypad, at the prompt >.

On the parameter and diagnosis screens, the key-in line appears when numeric data is keyed in, even if the [(OPRT)] soft key has not been pressed.

(5) Data input/output

Once input/output units have been set up, data input/output is started by first pressing the [READ] or [PUNCH] soft key on the parameter screen, then [EXEC].

Keep in mind that it is impossible to switch to another screen during an input/output operation. The input/output operation is discontinued if an alarm condition is detected during communication.

D.1.4.3 Operations of an Active Slave

- (1) Selecting an active slave
 - 1 Pressing the [(OPRT)] soft key prepares the required processes, such as data rewrite and data search, for execution.
 - 2 The cursor and page keys on the MDI keypad can be used to move the cursor or display another page for the active slave.
 - 3 To reselect the active slave, use the [↑ BACK] and [↓ NEXT] soft keys. These soft keys are displayed by pressing the previous-menu key to return to the soft key menu that was displayed before [(OPRT)] was pressed, then the next-menu key several times.

- (2) Alarms
 - 1 CNC

If an alarm condition occurs in the CNC, switching to the CNC alarm screen may be automatically done, depending on the setting of bit 7 (NPA) of CNC parameter P3111. Check the description of the alarm and, if necessary, press the SYSTEM function key to return to the screen of this function.

P3111 bit7 (NPA)

0: Switching to the alarm screen takes place upon occurrence of an alarm condition.

1: Switching to the alarm screen does not take place upon occurrence of an alarm condition.
 - 2 Slave

Usually, a guidance message is displayed on the message line. If an alarm condition occurs in the servo amplifier module, the group number for the servo amplifier unit is displayed at the right end of the line. See the alarm screen for details of the alarm.

- (3) Data protection key

When a memory protection signal (KEY) of the CNC is off, parameters cannot be input to the CNC memory.

D.1.5 FUNCTION DETAILS

D.1.5.1 System Configuration

This screen contains system software information about the servo amplifier module, and amplifier ID information (only for single-slave display).

This is the first screen to appear when a Power Mate CNC manger function is selected.

(1) Display operations

Pressing the [SYSTEM] function selection soft key displays the following soft key menu and the screen that was displayed when SYSTEM was previously selected. The soft key for the currently displayed function is displayed in reverse video.

[PARAM][DGNOS][] [SYSTEM][OPRT]

Pressing the [SYSTEM] soft key again selects and displays the system configuration screen. While this screen is displayed, the [SYSTEM] soft key is displayed in reverse video.

(2) Displays

For single-slave display, the screen displays the series and edition of system software for the servo amplifier module, and amplifier ID information.

For four-slave display, the screen displays only the series and edition of system software.

POWER MATE CNC MANAGER			
SYSTEM CONFIGURATION			
1. GROUP 0 / β i			
SYSTEM	(SERIES/VERSION)	88A6	01
AXIS NAME	X1		
I/O CH-GROUP	1-1		
AMP NUMBER	A1-L		
UNIT KIND	SVM		
MAX CURRENT	20A		
SERVO AMP SPEC.	A06B-6130-H002		
SERVO AMP S/N	V03709424		
SELECT ACTIVE SLAVE [>]			
[PARAM]	[DGNOS]	[]	[SYSTEM]

Single-slave display example: the series and edition of system software, amplifier ID information

(3) Details of amplifier ID information

1 AXIS NAME

Displays an axis name.

[Example]

When parameter P24 is 88, parameter P25 is 49:

X1

2 I/O CH-GROUP

Displays a channel number and group number of an I/O Link.

[Format]

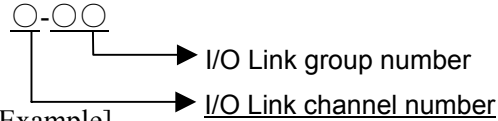

[Example]

1CH group 0: βi → 1- 0

1CH group 1: I/O → Not displayed (unsupported)

1CH group 2: βi → 1- 2

2CH group 0: β → Not displayed (unsupported)

2CH group 1: βi → 2- 1

2CH group 2: βi → 2- 2

3 AMP NUMBER

Displays an amplifier number.

[Format]



[Example]

1CH group 0: βi → A1-L

1CH group 1: I/O → Not displayed (unsupported)

1CH group 2: βi → A2-L

2CH group 0: β → Not displayed (unsupported)

2CH group 1: βi → A2-L

2CH group 2: βi → A3-L

4 UNIT KIND

Displays a unit type.

[Example]

SVM (including αi)

SVU

SVM-HV

OTHER (others)

5 MAX CURRENT

Displays a maximum current value.

[Example]

4A

20A

40A

80A

160A

6 SERVO AMP SPEC.

Displays a servo amplifier ordering code.

[Example]

A06B-6130-H002

7 SERVO AMP S/N

Displays a servo amplifier serial number.

[Example]

V03709424

NOTE

Amplifier ID information can be displayed only with an 8A01 series Power Mate CNC manager, and is not displayed with an 8A00 series Power Mate CNC manager.

D.1.5.2 Parameters

The parameters required for each function of the servo amplifier module must be set up in advance.

(1) Display operations

Pressing the [SYSTEM] function selection soft key displays the following soft key menu:

[PARAM][DGNOS][] [SYSTEM][OPRT]

Pressing the [PARAM] soft key displays the parameter screen.

(2) Displays

POWER MATE CNC MANAGER			
PARAMETER			
1. GROUP0 / β i			
0000	00001000	0010	11110000
0001	00010101	0011	01010000
0002	11111011	0012	00000000
0003	00000000	0013	00000000
0004	00000000	0014	10110001
0005	10100001	0015	00000000
0006	00000000	0016	00000000
0007	10000000	0017	10000010
0008	00000000	0018	00000000
0009	00000000	0019	00000000
SELECT ACTIVE SLAVE [>]			
[PARAM]	[DGNOS]	[]	[SYSTEM] [OPRT]

This screen displays bit-type and decimal data only.

(3) Saving parameters

Parameters can be saved as program data files to the CNC memory or to a memory card. (This processing is regarded as READ processing when viewed from the Power Mate CNC manager.)

NOTE

To save parameters to the CNC memory, set bit 0 (TVC) of CNC parameter P0 to 0.

P0 bit 0 (TVC)

0: No TV check is made.

1: A TV check is made.

To save parameters, first set the first registration program number in parameter P8760. Programs are created using a number assigned to each servo amplifier unit. This number is treated as a program number when the parameters are saved to the CNC

memory. The following shows the convention of naming files for saving parameters to a memory card.

O+Program number.PMM

Program number = [P8760 setting] + [Group number n]*10

[Example]

When P8760 is 8000 and a group number is 1, the file name is:

O8010.PMM

The group number is a number in "group n" displayed in the title of a servo amplifier module.

If the program number is already in the memory, the setting of bit 2 of CNC parameter P3201 (REP) is followed.

P3201 bit2(REP)

- 0: If the same number is found during program registration, an alarm is issued.
- 1: If the same number is found during program registration, the existing program is overwritten with the new data.

Use bits 1 and 2 of parameter P960 to select data input/output destinations.

See Section D.1.3.5 for details.

Connect a memory card or determine how much space is available on the CNC memory, and then perform the steps below.

- 1 Select an active slave.
- 2 Press the [(OPRT)] soft key to display:
[NO.SRC][][][] [INPUT]
Press the next-menu key.
[][] [READ] [PUNCH] [][]
- 3 Press the [READ] soft key to display:
[][][] [CANCEL] [EXEC]
Press the [EXEC] soft key.
While the parameters are being saved, the message "INPUT" blinks on the message line.

(4) Writing parameters

Parameter data files saved as programs to the CNC memory or memory CAD can be restored and written to the servo amplifier module determined from a program number. The program number and device are determined using the same method as in item (3).

- 1 Select an active slave.
- 2 Press the [(OPRT)] soft key to display:
[NO.SRC][][][] [INPUT]
Press the next-menu key.
[][] [READ] [PUNCH] [][]
- 3 Press the [PUNCH] soft key to display:
[][][] [CANCEL] [EXEC]
Press the [EXEC] soft key.
While the parameters are being written, the message "OUTPUT" blinks on the message line.

- (5) Searching for parameters
A parameter can be searched for and displayed by means of the following procedure.
- 1 Select an active slave.
 - 2 Press the [(OPRT)] soft key to display:
[NO.SRC][][][][INPUT]
 - 3 Key in a desired number on the key-in line using the MDI keypad, then press the [NO.SRC] soft key to start the search.
- (6) Setting parameters
Parameters for servo amplifier modules can be set directly from the CNC by means of the following procedure.
- 1 Select an active slave.
 - 2 Press the [(OPRT)] soft key to display:
[NO.SRC][][][][INPUT]
 - 3 Position the cursor to the desired parameter.
 - 4 Key in the desired data on the key-in line using the MDI keypad, then press the [INPUT] soft key or the INPUT key on the MDI keypad.

D.1.5.3 Diagnosis

The status of the current processing for a servo amplifier module can be referenced using the diagnosis screen.

- (1) Display operations
Pressing the [SYSTEM] function selection soft key displays the following soft key menu:
[PARAM][DGNOS][][][SYSTEM][[(OPRT)]]
Pressing the [DGNOS] soft key displays the diagnosis screen.
- (2) Displays
Basically, the same screen as that used for parameter handling is used.
See Appendix C "DIAGNOSIS LISTS" for contents.
- (3) About memory dumping
Internal information on a servo amplifier module can be stored on a memory card.

NOTE

Memory dumping is a maintenance function, and is normally not used. However, a FANUC service representative may ask you to do some work using this function.

Operation method

Operation is performed on the single-slave display screen. Ensure that a memory card is connected, and then perform the steps below.

- 1 Select an active slave.
- 2 Press the [(OPRT)] soft key to display:
[NO.SRC][][][][][]

Set an axis name for coordinates using two characters (parameters P24 and P25). If a setting is out of range, " " (space) is displayed. When parameter P24 is set to 0, an axis name is 1, regardless of the setting of parameter P25.

For details, see the description of parameters P24 and P25 in Section B.5.

D.1.5.5 Machine Coordinates

The current position can be displayed using a machine coordinate system.

(1) Display operations

Pressing the [POS] function selection soft key displays the following soft key menu:

[WORK][][MACHIN][][]

Pressing the [MACHIN] soft key displays the machine coordinate screen.

(2) Displays

Basically, the same screen as that used for the absolute coordinates is used for the machine coordinates.

D.1.5.6 Alarms

If an alarm condition occurs in processing for a servo amplifier module, the group number for the amplifier is displayed at the right end of the message line on each screen. The alarm can be checked on the corresponding alarm screen.

Example: "13" (indicating that an alarm condition has occurred in servo amplifier modules in groups 1 and 3).

(1) Display operations

Pressing the [MSG] function selection soft key displays only an error code on the screen.

(2) Displays

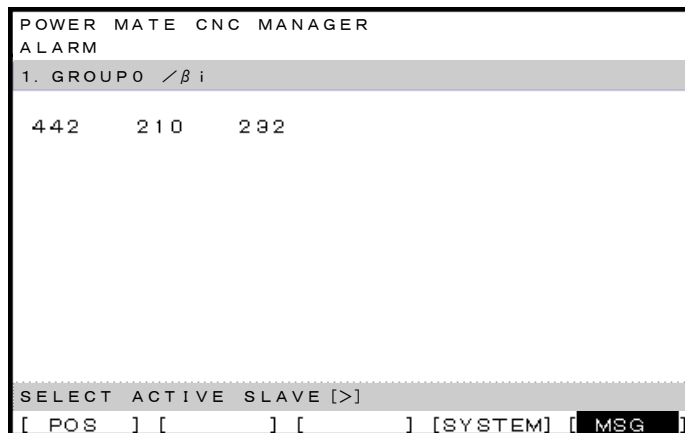

Up to 40 items can be displayed.

D.1.6 Alarm Display on the Power Mate CNC Manager

If an alarm occurs in the power mate CNC manager, the alarm number and message are displayed on the message line.

Number	Message	Contents
003	PROGRAM NOT REGISTERED	An attempt was made to punch a program not found in the program area using "PUNCH" (program → servo amplifier module).
004	PROGRAM PROTECTED	An attempt was made to execute "READ" (servo amplifier module → program) on the program area when the memory protection key (KEY) was off.
009	CNC DATA NOT CORRECT	An attempt was made to execute "READ" (servo amplifier module → program) when the program area already contained a program with the same name as that to be created by executing "READ" (servo amplifier module → program). An attempt was made to execute "READ" (servo amplifier module → program) when the same program number as that of the program to be created by executing "READ" (servo amplifier module → program) was selected. An attempt was made to execute "READ" (servo amplifier module → program) when bit 0 (TVC) of CNC parameter P0 is 1. (Parameters No. 0 to No. 19 are output, but parameter No. 20 and later are not output.)
018	MEMORY OVER FLOW	An attempt was made to execute "READ" (servo amplifier module#program) when the program area did not have enough free space.
054	GROUP NOT CONNECTED	The servo amplifier module is not connected.
056	FORMAT ERROR	Data other than digits, signs, CAN, and INPUT was entered as a parameter setting.
057	TOO MANY DIGITS	Data of 9 or more digits was entered for a bit-type parameter.
058	DATA IS OUT OF RANGE	The setting exceeds the valid data range.
064	FILE NOT REGISTERED	An attempt was made to execute "PUNCH" (memory card → servo amplifier module) when the memory card did not contain a program to perform "PUNCH" (memory card → servo amplifier module).
079	UNEXPECTED ALARM	An attempt was made to execute "READ" (servo amplifier module → memory card) when the memory card was protected.
081	THIS PARAMETER IS UNAVAILABLE	An attempt was made to set a value for a parameter not available to the servo amplifier module.

D.2 POWER MATE CNC MANAGER FUNCTION (Series 30i, 31i, 32i)



When the I/O Link Option for the FANUC servo unit β series (called I/O Link β below) is used for CNC additional axes (slaves), the Power Mate CNC manager function can be used to display and set up various types of data of these slaves on the CNC.

The Power Mate CNC manager function enables the following display and setting operations:





- (1) Current position display (absolute/machine coordinates)
- (2) Parameter display and setting
- (3) Alarm display
- (4) Diagnosis data display
- (5) System configuration screen display

Up to eight slaves can be connected to each I/O Link channel.

D.2.1 Screen Display

- 1 Press the function key .
- 2 Press the continuous menu key  several times until the  soft key is displayed.



- 3 Pressing the [P.MATE MGR.] soft key displays the absolute coordinate screen, which is the initial screen of the Power Mate CNC manager. On this screen, you can select each of the following items by pressing the corresponding soft key:
 - ABS: Absolute coordinate display
 - MACHIN: Machine coordinate display
 - PARAM: Parameter screen
 - MSG: Alarm list
 - DGNOS: Diagnosis screen
 - SYSTEM: System information
 To select another function after one of the functions listed above is selected, press the return menu key  until the soft keys appear as shown above. Then, select the desired function.
- 4 Terminating the Power Mate CNC manager function
 Press the return menu key once or twice. The soft keys of the CNC system appear, and the Power Mate CNC manager terminates. Alternatively, you can select another function by pressing an MDI function key (, , , etc.) to terminate the Power Mate CNC manager function.

Selecting a slave

When slaves are connected to multiple I/O Link channels, pressing [NEXT CHANNEL] or [PREVIOUS CHANNEL] displayed by pressing the [(OPRT)] soft key changes the displayed channel.

In the upper section of the screen, the following information items are displayed for the connected slaves (up to eight slaves):

- I/O Link group number (0 to 15)
- Alarm status

The cursor is positioned at the number of the slave for which to display information (active slave). When multiple slaves are connected, pressing the [NEXT SLAVE] or [PREVIOUS SLAVE] changes the active slave.

You can display the slave status and select a slave on any screen of the Power Mate CNC manager function.

Current position display screen

The current position display screen displays the current position and actual feedrate of the slave.

The following current position data is displayed:

Absolute coordinate (current position in the absolute coordinate system)

Machine coordinate (current position in the machine coordinate system)

- Display method

Press the [ABS] or [MACHIN] soft key. The absolute or machine coordinate screen appears as follows:

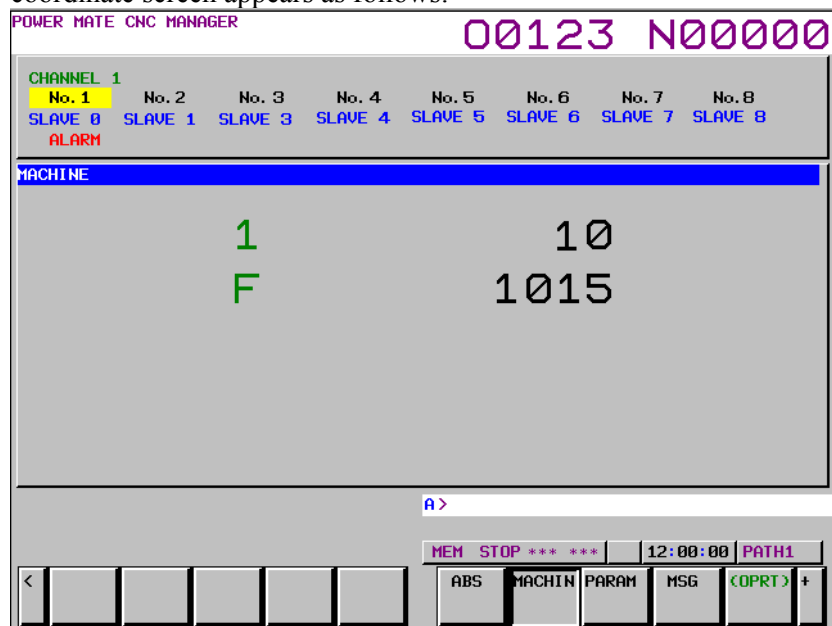

Power Mate CNC manager: Machine coordinate screen

Axis name display

You can change the axis name by setting it in the I/O Link β parameters (Nos. 0024 and 0025). Up to two characters can be set. (Use the ASCII codes of 0 to 9 and/or A to Z). When no axis name is set or the setting data is invalid, the axis name is set to 1.

This axis name is used only for position display of the Power Mate CNC manager function and irrelevant to the controlled axis on the CNC.

Parameter screen

The parameters required for the functions of the slave must be specified in advance.

Press the [PARAM] soft key. The following parameter screen appears:

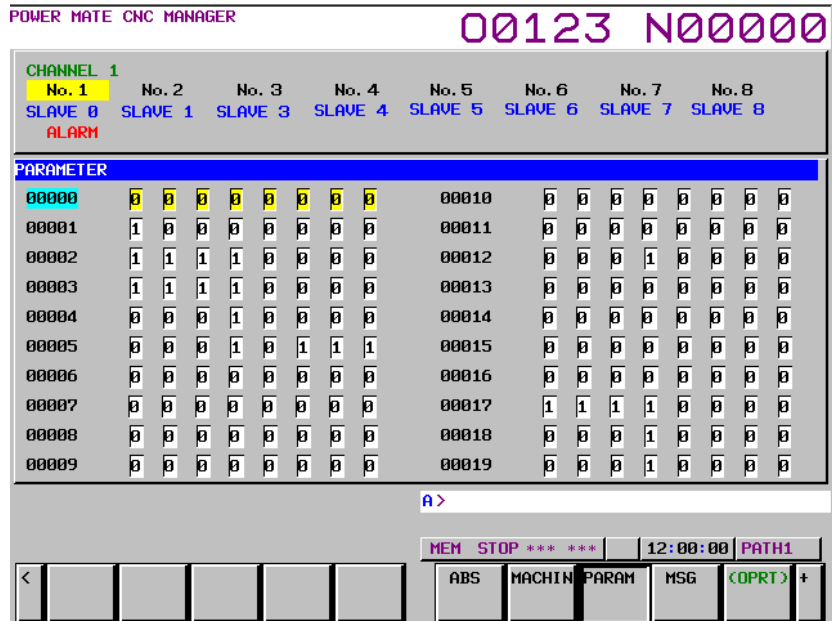







This screen displays only the bit and decimal data.

- Selecting and searching for a parameter
 - 1 First, select the active slave.
 - 2 Press the [(OPRT)] soft key. The following soft keys appear:



- 3 Enter a parameter number and press the [NO. SRH] soft key. The search starts.

You can also select a desired parameter number by pressing the cursor keys     and page keys

  and moving the cursor.

- Setting a parameter
 You can directly set an I/O Link β parameter of the slave from the CNC.
 - 1 Select a desired parameter using either of the above methods.
 - 2 Press the [(OPRT)] soft key. The following soft keys appear:



- 3 Enter setting data.
- 4 Press the [INPUT] soft key or MDI key .

Alarm screen

If an alarm is issued for the slave, “ALARM” is displayed in the slave status field in the upper section of the screen.
 At this time, you can display the alarm screen to check the details of the alarm.
 Up to 40 alarm codes are displayed on the screen.

- Display method

Press the [MSG] soft key. On the screen, only error codes are displayed.

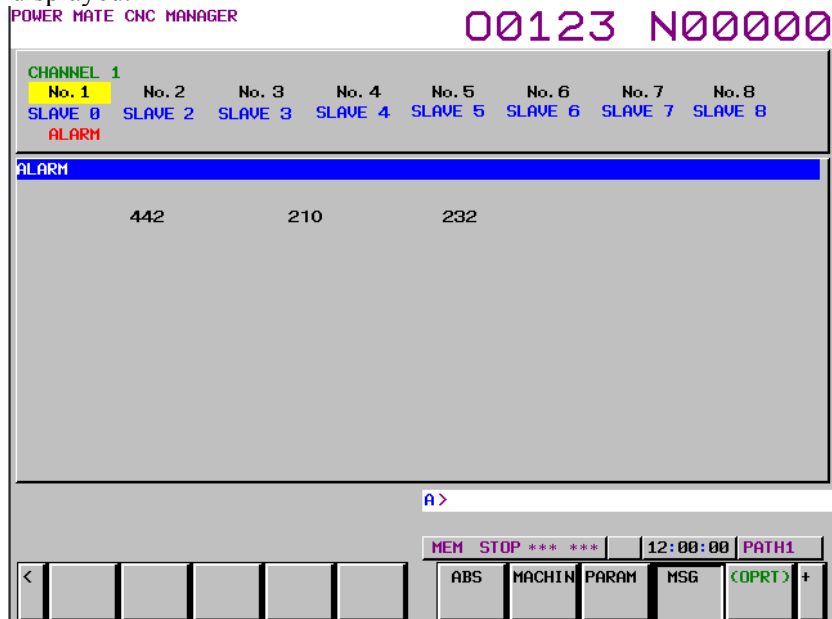

Example of displaying alarms for I/O Link β of slave 0

Diagnosis screen

The diagnosis screen displays diagnosis information of the slave. Diagnosis data is displayed in bit or integer (decimal) representation.

- Display method

- 1 Press the continuous menu key .
- 2 Press the [DGNOS] soft key to select the diagnosis screen.

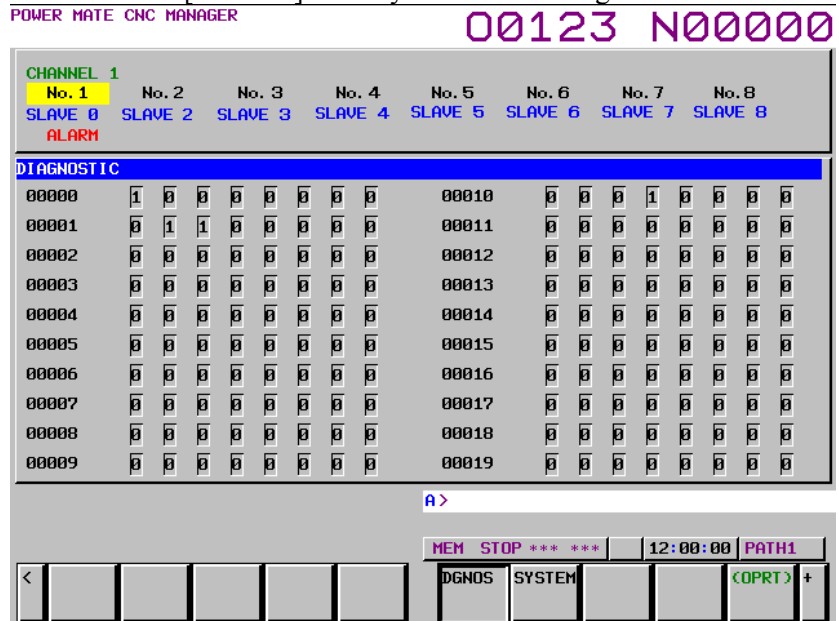



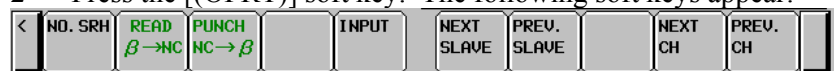

Searching for diagnosis data

- 1 First, select the active slave.
- 2 Press the [(OPRT)] soft key. The following soft keys appear:



- 3 Enter a diagnosis number and press the [NO. SRH] soft key. The search starts.

You can also select a desired parameter number by pressing the cursor keys   and page keys   and moving the cursor.

System configuration screen

The system configuration screen displays the system software information of the slave.

- Display method

- 1 Press the continuous menu key .
- 2 Press the [SYSTEM] soft key to select the system configuration screen.

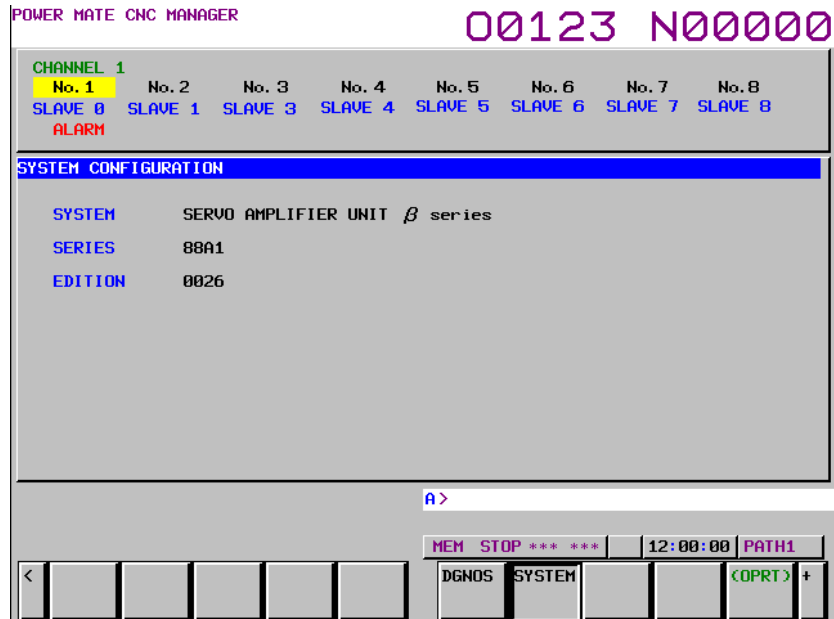

Series and edition of the I/O Link beta system software

D.2.2 Inputting and Outputting Parameters

Outputting parameters

Parameters are output to the CNC memory or a memory card as a data file in the program format. Set the first registration program number in parameter No. 8760. For each slave, program with a predetermined number is created.

When parameters are output to the CNC memory, a program with the specified program number is created.

When parameters are output to a memory card, a file is created, of which file name consists of the specified program number and an extension PMM.

Program number = setting-of-parameter (parameter No. 8760) + (m - 1) × 100 + n × 10

m: Channel number (1 to 4)

n: Group number

Example: When parameter No. 8760 is set to 8000

Channel 1 (I/O Link β: Group 0)

$$8000 + 0 * 100 + 0 * 10 = 8000$$

Channel 2 (I/O Link β: Group 1)

$$8000 + 1 * 100 + 1 * 10 = 8110$$

Channel 3 (I/O Link β: Group 2)

$$8000 + 2 * 100 + 2 * 10 = 8220$$

Channel 4 (I/O Link β: Group 3)

$$8000 + 3 * 100 + 3 * 10 = 8330$$

The group number is the slave number displayed in the slave status field in the upper section of the screen in reverse video.

When bit 3 (PMO) of parameter No. 0961 is set to 1, the numbers of the parameters to be output can be set only with a group number.

Select a desired input device using bits 1 (MD1) and 2 (MD2) of parameter No. 0960.

Connect a memory card or check the unused area of the CNC memory, then follow the steps below:

- 1 For multipath control, display the Power Mate CNC manager screen from the screen for path 1.
- 2 Select the active slave.

Press the [(OPRT)] soft key. The following soft keys appear:



- 3 Press the [READ] soft key. The following soft keys appear:



- 4 Press the [EXEC] soft key.
During input, "INPUT" blinks in the message field.

NOTE

- 1 Parameters can be saved in other than the MEM mode or in the emergency stop status.
- 2 To save parameters in a memory card, if a file with the same name is found in the memory card, the parameters cannot be saved. Delete the file from the memory card or change the file name by setting parameter No. 8760.
To save parameters in a program area, save operation is performed according to the setting of bit 2 (REP) of parameter No. 3201.

Inputting parameters

A data file of parameters output to the CNC memory or a memory card as a program is input to the slave determined by the program number. The program number and memory device are determined as described in “Outputting parameters.”

- 1 For multipath control, display the Power Mate CNC manager screen from the screen for path 1.
- 2 Select the active slave.
- 3 Press the [(OPRT)] soft key. The following soft keys appear:

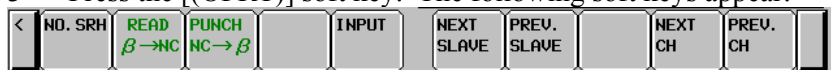

- 4 Press the [PUNCH] soft key. The following soft keys appear:



- 5 Press the [EXEC] soft key.
During output, “OUTPUT” blinks in the message field.

NOTE

- 1 Parameters can be input in other than the MEM mode or in the emergency stop status.
- 2 For multipath control, parameters can be input and output only using the Power Mate CNC manager screen for path 1. They can only be input from and output to the CNC memory for path 1.

D.2.3 Parameters

	#7	#6	#5	#4	#3	#2	#1	#0
0960				PPE	PMN	MD2	MD1	

[Input type] Setting input
 [Data type] Bit path

1 MD1
 # 2 MD2

The slave parameters are input from and output to either of the following devices:

Parameter MD2	Parameter MD1	I/O destination
0	0	Program memory
0	1	Memory card

3 PMN The Power Mate CNC manager function is:
 0: Enabled.
 1: Disabled. (Communication with the slave is not performed.)

4 PPE Setting slave parameters using the Power Mate CNC manager:
 0: Can always be performed regardless of the setting of PWE.
 1: Follows the setting of PWE.

	#7	#6	#5	#4	#3	#2	#1	#0
0961					PMO			

[Input type] Parameter input
 [Data type] Bit

3 PMO The O number of a program for saving and restoring the I/O LINK β parameter is set based on:
 0: Group number and channel number
 1: Group number only

8760	Program number of data input/output (Power Mate CNC manager)
------	--

[Input type] Setting input
 [Data type] 2-word path
 [Valid data range] 0 to 99999999

This parameter sets the program numbers of programs to be used for inputting and outputting slave data (parameters) when the Power Mate CNC manager function is used.
 For a slave specified with I/O LINK channel m and group n, the following program number is used:
 Setting + (m - 1) × 100 + n × 10

If the setting is 0, the parameters of the slave specified with channel 1 and group 0 cannot be input from or output to the CNC memory because the program number is set to 0. The parameters can be input from and output to a memory card.

(Set a value with which any used program number does not exceed 99999999.)

D.2.4 Warning

If an alarm is issued for the Power Mate CNC manager, a warning message is displayed.

Message	Description
DATA ERROR	An attempt was made to execute [PUNCH] (NC → β) for a program not found in the program area.
WRITE PROTECTED	An attempt was made to execute [READ] (β → NC) for a program area when the memory protection signal (KEY) is off.
EDIT REJECTED	An attempt was made to execute [READ] (β → NC) when the program area already contained a program with the same name as that to be created by executing [READ] (β → NC). An attempt was made to execute [READ] (β → NC) when the number of the program to be created by executing [READ] (β → NC) was selected. An attempt was made to execute [READ] (β → NC) when bit 0 (TVC) of CNC parameter No. 0000 was set to 1. (Parameters Nos. 0000 to 0019 are output, but parameter No. 0020 and subsequent parameters are not output.) An attempt was made to execute [PUNCH] (NC → β) when a memory card did not contain any program for which [PUNCH] (NC → β) could be executed. An attempt was made to execute [READ] (β → NC) for a protected memory card.
NO MORE SPACE	An attempt was made to execute [READ] (β → NC) when the program area did not have enough unused space.
FORMAT ERROR	Data other than digits, signs, CAN, and INPUT was entered as the setting of a parameter.
TOO MANY FIGURES	Data consisting of 9 or more digits was entered for a bit-type parameter.
DATA IS OUT OF RANGE	The setting exceeds the valid data range.

D.2.5 Note

I/O Link connection

To use I/O Link β as a slave of I/O Link, assign I/O addresses on the CNC side. Since I/O data for slaves is handled in 16-byte units, be sure to specify 128 input/output points.

A maximum of eight slaves can be connected.

The module names are OC021 (16-byte input) and OC020 (16-byte output).

BASE is always 0 and SLOT is always 1.

Power Mate CNC manager neglect function

After necessary data settings and confirmation are made for each of connected slaves, it is possible to stop communication by the Power Mate CNC manager function to precede commands from the ladder on the CNC side to each slave.

When bit 3 (PMN) of parameter No. 960 is set to 1, all communication with slaves over I/O Link is open to the ladder. Setting this parameter to 1 also disables the Power Mate CNC manager function.

Data protection key

When the CNC program data protection key is ON, no parameters can be input to the CNC program memory.

E

SERVO CHECK BOARD

(1) Overview

The servo check board converts digital values, used in digital servo control, to an analog voltage so that they can be observed on an oscilloscope.

(2) Servo check board ordering information

Ordering code	Name
A06B-6057-H630	Servo check board
A06B-6093-K021	Check board adapter (comes with cables, and is dedicated to βi amplifier with I/O Link)

(3) Servo check board connection

Ensure that the power to the βi SVM is turned off, and then connect the servo check board.

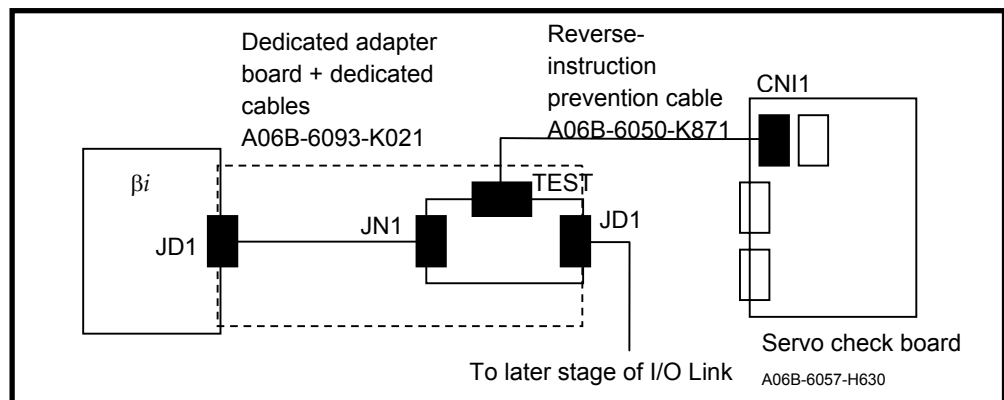

NOTE

The servo check adapter and servo check board can be connected only during maintenance. Do not start operation when the connection is still established.

(4) Signal output locations

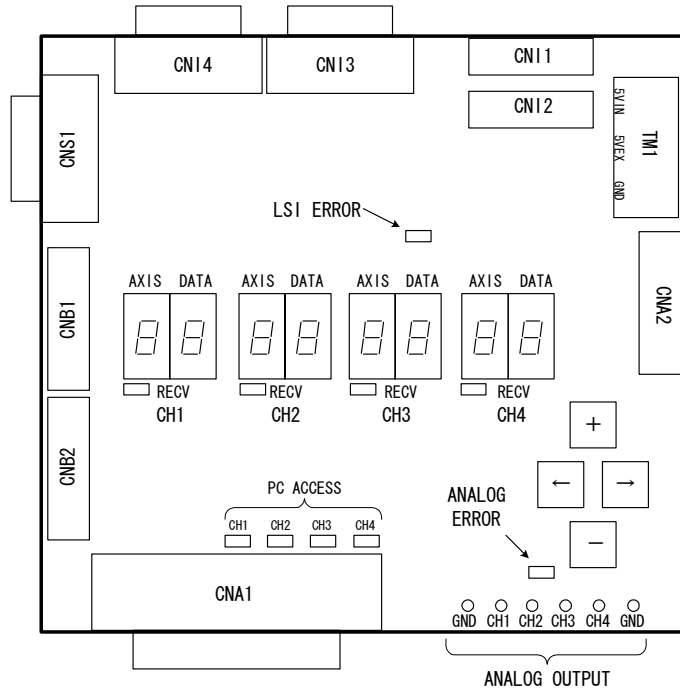

Set the type of data to observe using a set of two 7-segment LED digits.

Set 1 in the AXIS digit.

Set the type of data (tables below) to observe in the DATA digit.

Data is not output to a channel for which the RECV LED stays off.

When bit 0 of parameter No. 14 is 0 and bit 1 is 0:

AXIS	DATA	Data type
1	0	Velocity command (VCMD)
1	1	Torque command (TCMD)
1	2	Velocity signal (TSA)
1	4	Position signal

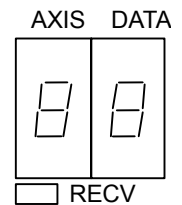

When bit 0 of parameter No. 14 is 1 and bit 1 is 0:

AXIS	DATA	Data type
1	0	R-phase actual current
1	1	S-phase actual current
1	2	Velocity signal (TSA)
1	4	Position signal

When bit 0 of parameter No. 14 is 0 and bit 1 is 1:

AXIS	DATA	Data type
1	0	Specified acceleration
1	1	Estimated load torque
1	2	Velocity signal (TSA)
1	4	Position signal

(5) Velocity command (VCMD)

The VCMD signal is used to output a velocity command. This signal can also be used to measure the minute vibrations of the motor and any uneven feed.

Before observing this signal, check that bits 0 and 1 of parameter No. 14 are 0 and 0.

The amplitude of the VCMD signal can be switched using bits 0 and 1 of parameter No. 13.

The VCMD signal switches between +5 V and -5 V. Switch the amplitude using this parameter if it is difficult to observe the waveform.

	b7	b6	b5	b4	b3	b2	b1	b0
No.13							VCM2	VCM1

VCM2	VCM1	Number of specified revolutions/5 V
1	1	0.9155 min ⁻¹
1	0	14 min ⁻¹
0	1	234 min ⁻¹
0	0	3750 min ⁻¹

First, observe the entire waveform of the signal using the DC mode of the oscilloscope, then switch to AC mode and enlarge the range. Minute vibration and uneven positional shifts can be checked.

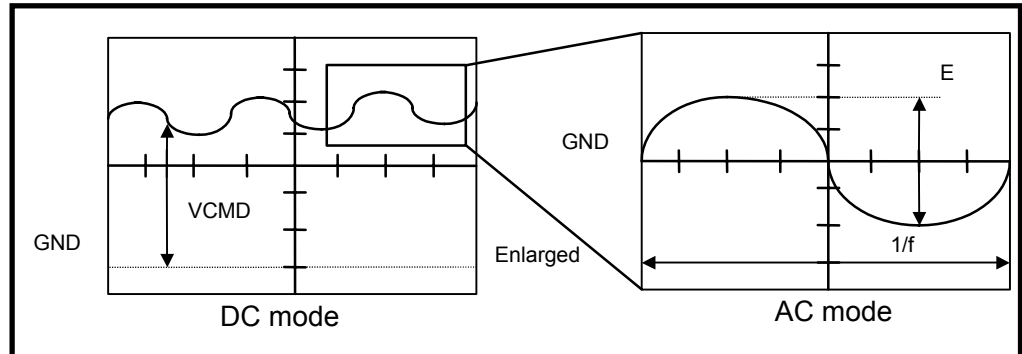

Letting W (min⁻¹/5 V) be the signal conversion ratio of the VCMD waveform, the voltage per positional deviation amount pulse is:

$$\text{Voltage (V) per positional deviation amount pulse} = \frac{300 \times \text{position gain (s}^{-1}\text{)}}{\text{Number of position feedback pulses / motor revolution} \times W}$$

(Example)

Supposing position gain = 30 (s⁻¹), number of position feedback pulses/motor revolution = 10,000, E = 300 mV, 1/f = 20 ms, VCM1 = 0, and VCM2 = 1, the voltage per positional deviation pulse is: 64 mV/pulse

Thus:

Table vibration = 300 × 1/64 = 4.6 μm

Vibration cycle = 50 Hz

(6) Torque command (TCMD)

The TCMD signal is used to output a motor torque command. When the motor is rotating at high speed, the current indicated by this signal may differ from the actual motor current (IR or IS) because of the back electromotive force in the motor.

Before observing this signal, check that bits 0 and 1 of parameter No. 14 are 0 and 0.

Maximum current	Maximum-current signal output	Applicable servo motor
4A p	4.44V	$\beta 0.2/5000is$, $\beta 0.3/5000is$
20A p	4.44V	$\alpha 1/5000i$, $\beta 2/4000is$, $\alpha 2/5000i$, $\beta 4/4000is$, $\beta 8/3000is$, $\alpha 2/5000is$, $\alpha 4/5000is$, $\alpha C4/3000i$, $\alpha C8/2000i$, $\beta 0.4/5000is$, $\beta 0.5/5000is$, $\beta 1/5000is$, $\alpha C12/2000i$
40A p	4.44V	$\beta 12/3000is$, $\alpha 4/4000i$, $\beta 22/2000is$, $\alpha 8/3000i$, $\alpha C22/2000i$
80A p	4.44V	$\alpha 8/4000is$, $\alpha 12/4000is$, $\alpha 12/3000i$, $\alpha 22/3000i$, $\alpha C30/1500i$

Effective (RMS) value = TCMD signal output (Ap) \times 0.71

(7) Velocity signal (TSA)

The TSA signal is used to output the rotational speed of the motor. The amplitude of the signal can be switched using bits 4 and 5 of parameter No. 13.

The TSA signal switches between +5 V and -5 V. Switch the amplitude using this parameter if it is difficult to observe the waveform.

No.13	b7	b6	b5	b4	b3	b2	b1	b0
			TSA2	TSA1				

TSA2	TSA1	Number of specified revolutions/5 V
1	1	0.9155 min^{-1}
1	0	14 min^{-1}
0	1	234 min^{-1}
0	0	3750 min^{-1}

(8) Position signal

A position signal is output.

A signal of 5 V indicates an amount of movement of $2048 \times$ detection unit.

Example)

When the detection unit is $1 \mu\text{m}$:
5 V indicates 2.048 mm.

(9) R-phase actual current, S-phase actual current

An R-phase actual current and S-phase actual current of the motor are output.

Before observing the signal, check that bits 0 and 1 of parameter No. 14 are 1 and 0.

Maximum current	Maximum-current signal output	Applicable servo motor
4A p	4V	$\beta 0.2/5000is$, $\beta 0.3/5000is$
20A p	4V	$\alpha 1/5000i$, $\beta 2/4000is$, $\alpha 2/5000i$, $\beta 4/4000is$, $\beta 8/3000is$, $\alpha 2/5000is$, $\alpha 4/5000is$, $\alpha C 4/3000i$, $\alpha C 8/2000i$, $\beta 0.4/5000is$, $\beta 0.5/5000is$, $\beta 1/5000is$, $\alpha C 12/2000i$
40A p	4V	$\beta 12/3000is$, $\alpha 4/4000i$, $\beta 22/2000is$, $\alpha 8/3000i$, $\alpha C 22/2000i$
80A p	4V	$\alpha 8/4000is$, $\alpha 12/4000is$, $\alpha 12/3000i$, $\alpha 22/3000i$, $\alpha C 30/1500i$

(10) Specified acceleration, estimated load torque

A specified acceleration and estimated load torque are output.

Before observing this signal, check that bits 0 and 1 of parameter No. 14 are 0 and 1.

The unit is same as TCMD. (The maximum current is 4.44 V.)

This signal is used to adjust the unexpected disturbance torque detection function.

INDEX

<A>

Absolute Coordinate.....	307
ACCELERATION/DECELERATION CONTROL	
PARAMETERS	250
ACCELERATION/DECELERATION DELAY	
AMOUNT (SERVO AMPLIFIER MODULE).....	291
ACTION AGAINST NOISE.....	201
Alarm	46, 94, 99, 183, 308
Alarm (DAL).....	134
Alarm Display on the Power Mate CNC Manager.....	309
ALARM NUMBERS AND BRIEF DESCRIPTIONS..	190
ATC/Turret Control	76
Automatic Operation.....	55
Axis Movement Commands.....	154

BATTERY FOR THE ABSOLUTE PULSECODER.....	20
--	----

<C>

CAUTIONS ON USING THE POWER MATE CNC	36
CHECK PROCEDURE.....	16
Checking the Voltage and Capacity of the Power.....	9
Clamp and Unclamp (for the Peripheral Equipment	
Control Interface Only).....	56
Command Completion Notification (ECF)	133
COMMAND FORMAT FOR PERIPHERAL	
EQUIPMENT CONTROL.....	72
Command timing chart.....	89, 99
CONFIGURATIONS.....	4, 5
CONFIRMATION OF THE OPERATION	15
Connecting a Protective Ground	9
CONNECTING THE POWER	9
Control of the Point Data External Setting Function.....	100
CONTROLLED-AXIS PARAMETERS.....	242
COORDINATE SYSTEM AND STROKE LIMIT	
PARAMETERS	243
Coordinate System Setting.....	96

<D>

DAILY INSPECTION OF AC SERVO MOTORS	223
Deceleration limit switch installation condition.....	103
DETAILED DESCRIPTION	171
DETAILS OF DIRECT COMMAND FUNCTIONS....	136

Details of Function.....	109, 114, 124
DETAILS OF FUNCTION CODES	76
Details of the Setup Method.....	176
DI/DO Signals.....	110
DIAGNOSIS	183
Diagnosis.....	306
DIAGNOSIS LISTS.....	288
DIGITAL SERVO STANDARD PARAMETER	
TABLE.....	286
DIRECT COMMAND CONTROL PROCEDURE	131
Direct Command Control Procedure	131
Direct Command Execution Result	134
DIRECT COMMAND FORMAT	129
Direct Command Function Code and Related	
Information	62
Direct Command Interface	35, 40
Direct Command Interface (DRC = 1).....	289, 290
DIRECT COMMANDS	128
DIRECT INPUT SIGNAL STATUSES (SERVO	
AMPLIFIER MODULE)	291
Direct Input Signals.....	68
Disabling of Clamp Processing When Jog Operation is	
Stopped	108
Disabling the Power Mate CNC Manager Functions	294
DO/DO SIGNALS	38

<E>

Example of program.....	107
Explanation of Function.....	102, 106, 107, 108, 108
EXTERNAL PULSE INPUT FUNCTION	169
External-Fan Motor.....	217

<F>

FANUC I/O LINK INTERFACE AREA	34
Feedrate.....	52
FEEDRATE PARAMETERS	247
For Fan Motors for Internal Agitation for SVM1-40i	
and SVM1-80i.....	216
For Fan Motors for Internal Agitation for SVM1-4i	
and SVM1-20i.....	215
FUNCTION BIT (SERVO AMPLIFIER MODULE)...	291
FUNCTION CODES.....	74
Function Codes.....	74

- FUNCTION DETAILS 302
- Function for Specifying the Direction of Rotation Axis
- High-speed Reference Position Return 106
- Function Overview 297
- Function Selection and Termination 293
- Function Selection Soft Key 294
- Fuse Locations 214
- <H>**
- HOW TO REPLACE THE FAN MOTOR 215
- HOW TO REPLACE THE FUSES AND PRINTED
- CIRCUIT BOARDS 211, 212
- <I>**
- I/O Link Connection 293
- IMPROVEMENT OF TURRET/MAGAZINE
- NUMBER OUTPUT 114
- INITIALIZING PARAMETERS
- (SWITCHES AND DUMMY CONNECTORS)..... 10
- INPUT/OUTPUT SIGNALS PARAMETERS 253
- Inputting and Outputting Parameters..... 317
- Instruction Command Control (EBUF, EBSY, and
- ECNT)..... 132
- INTERFACE 35
- Interface Switching 35
- Interlock 54
- <J>**
- Jog Feed 47
- <L>**
- LIST OF DIRECT COMMANDS..... 135
- <M>**
- Machine Coordinates 308
- MAJOR COMPONENTS 6
- MANUAL HANDLE INTERFACE 124
- Memory Registration Procedure 167
- Mode Selection 47
- <N>**
- Note 321, 112
- NOTES ON CONNECTING THE GROUND
- SYSTEMS 203
- NOTES ON SELECTING THE SPARK KILLER 206
- <O>**
- Operation Procedure..... 168
- Operations of an Active Slave 301
- Ordering Number of Printed Circuit Board 214
- Others 95
- <P>**
- Parameter
-92, 99, 105, 106, 107, 108, 108, 111, 120, 127, 137
- 181, 186, 304, 319
- PARAMETER INITIALIZATION 11
- PARAMETER LIST 235
- Parameter on the CNC (host) 127
- Parameter on the servo amplifier module..... 127
- Parameter Setting 295
- PERIODIC INSPECTION OF AC SERVO
- MOTORS 225
- PERIODIC MAINTENANCE OF SERVO
- AMPLIFIER 19, 28
- PERIPHERAL EQUIPMENT CONTROL 71
- Peripheral equipment control command format 87, 98
- Peripheral Equipment Control Function Code and
- Related Information 58
- Peripheral Equipment Control Interface 35, 38
- Peripheral Equipment Control Interface (DRC = 0)
- 289, 290
- PERIPHERAL EQUIPMENT CONTROL
- PROCEDURE 73
- Point Positioning Control 78
- Positioning Control (Absolute/Incremental
- Specification, for Skip Function) 84
- POWER MATE CNC MANAGER FUNCTION
- (Series 30i, 31i, 32i)..... 310
- POWER MATE CNC MANAGER FUNCTIONS 292
- POWER MATE CNC MANAGER FUNCTIONS
- (Series 16, 18, 21, Power Mate)..... 293
- PREFACE p-1
- Preparation Completion..... 44
- <Q>**
- QUICK STOP FUNCTION 184
- <R>**
- RECEIVING AND KEEPING AC SERVO MOTORS 222
- Receiving Response Data 73
- Reference Position Return 54, 80
- REFERENCE POSITION RETURN FUNCTION
- WITH DOGS 102

Reference position return operation (grid method)	102	SIGNALS SENT FROM SERVO AMPLIFIER	
Reference Position Setting (when the Reference		MODULE TO CNC (HOST)	290
Position External Setting Function is Used).....	82	Soft key status transition diagram	297
Related parameters	121	SPECIFICATION NUMBERS OF REPLACEMENT	
REPLACING THE PULSECODER	228	PARTS	230
Reset and Emergency Stop.....	45	Specifying Operation Using a Function Code	73
Response Command Control (EOREND, EOSTB,		Speed Control.....	86
EOPC, USR1, and ECONT)	133	Start of the Timer Counting Until Servo-off in Clamp	
Restriction	296	Processing	108
Rewriting of Parameters.....	97	START-UP PROCEDURE	7
Rotation Axis Rotation Direction Sign Specification		START-UP PROCEDURE (OVERVIEW).....	8
Function	107	Status Read.....	140
<S>		Status Signals	48
SAFETY PRECAUTIONS	s-1	System configuration.....	86, 97, 302
Screen configuration	299	<T>	
Screen Display	311	Teaching-based Data Setting Control.....	101
Selecting the Ground Fault Interrupter That Matches		Termination	294
the Leakage Current.....	9	THIRTY-TWO-BLOCK BUFFERING OPERATION. 167	
Selection.....	293	Tip 104	
SERIES AND EDITIONS OF APPLICABLE SERVO		<U>	
SOFTWARE	174	UNEXPECTED DISTURBANCE TORQUE	
SERIES AND EDITIONS OF APPLICABLE SERVO		DETECTION FUNCTION (OPTIONAL	
SOFTWARE	185	FUNCTION)	172
SERVO AMPLIFIER MODULE FRONT VIEW.....	233	UPGRADING OF THE CLAMP/UNCLAMP	
SERVO AMPLIFIER MODULE INTERFACE	34	CONTROL FUNCTION	108
Servo Amplifier Modules.....	6	UPGRADING OF THE RESPONSE DATA READ	
SERVO CHECK BOARD	322	FUNCTION	109
SERVO MOTOR MAINTENANCE	221	UPGRADING OF THE ROTATION AXIS CONTROL	
SERVO PARAMETERS	264	FUNCTION	106
SERVO POSITIONAL DEVIATION AMOUNT		<W>	
(SERVO AMPLIFIER MODULE).....	291	Warning.....	320
Servo-off	57		
SETTING METHOD	185		
SETUP METHOD	175		
Signal	94, 118, 125, 180		
SIGNAL DESCRIPTIONS	37		
SIGNAL DETAILS.....	44		
Signal on the CNC (host)	126		
Signal on the servo amplifier module.....	125		
Signal Operation Commands.....	136		
SIGNALS (LISTED IN GROUPS).....	42		
SIGNALS SENT FROM CNC (HOST) TO SERVO			
AMPLIFIER MODULE.....	289		

Revision Record

FANUC SERVO AMPLIFIER β i series (I/O Link Option) MAINTENANCE MANUAL (B-65395EN)

Edition	Date	Contents	Edition	Date	Contents	
01	Aug., 2004	_____				

